

MARCH 1954

35 CENTS

POPULAR MECHANICS MAGAZINE

WRITTEN SO YOU CAN UNDERSTAND

REG. U.S. TRADE MARK, GREAT BRITAIN, NO. 40428



**THE SHAPE OF
TOMORROW'S PLANES**
—Page 133

What Owners Think of the
'54 CHRYSLER
by Floyd Clymer

For the Craftsman
HOW TO HANG WALLPAPER
How to Buy an Outboard Motor

Copyrighted Material



Are you too old to learn?



not at all, new tests show!

EXPERT SAYS YOU CAN LEARN NEW TRICKS!

New tests, cited by an expert in news stories, show that: your ability to think increases with age; your powers of deduction are greater; your judgment is better.

I. C. S. KNEW IT ALL THE TIME! In the I. C. S. files are thousands of case histories of men and women of every age. Their successes, their promotions, their raises prove that men and women past school age can learn! Listen to A.L.G.* "Up until I took the course, I did what I was told. But now . . . I tell others what to do."

I. C. S. GIVES YOU EXPERT GUIDANCE FREE! Do you have the feeling you're "stuck" in your job?

Your trained I. C. S. counselor will appraise your abilities, help you plan for the future. Listen to D.F.K.* "Before enrolling, I was a foundry laborer. Today I am a draftsman, enjoying a 1/3 increase in salary."

IT'S NEVER TOO LATE TO GET STARTED! You study with I. C. S. at home, in your spare time. There's no interference with business or social activity. Famous I. C. S. texts make learning easy. And whatever your age, you're more capable now than you've ever been. But don't delay! Pick your field from the coupon below. Mail the coupon today! We'll send free "success" book, survey of opportunities in your field! *Mail now for 2 free books.*

*Names on request

I. C. S., Scranton 9, Penna.

INTERNATIONAL CORRESPONDENCE SCHOOLS

ICS

BOX 5613-L, SCRANTON 9, PENNA.

Without cost or obligation, send me "HOW to SUCCEED" and the booklet about the course BEFORE which I have marked X:

- | | | | | |
|--|---|---|---|---|
| <p>ART</p> <ul style="list-style-type: none"> <input type="checkbox"/> Commercial Art <input type="checkbox"/> Magazine Illustrating <input type="checkbox"/> Fashion Illustrating <input type="checkbox"/> Cartooning <input type="checkbox"/> Sketching and Painting <input type="checkbox"/> Show Card and Sign Lettering <p>AUTOMOTIVE</p> <ul style="list-style-type: none"> <input type="checkbox"/> Automobile, Mechanic <input type="checkbox"/> Auto Elec. Technician <input type="checkbox"/> Auto Body Rebuilding and Refinishing <input type="checkbox"/> Diesel-Gas Engines <p>AVIATION</p> <ul style="list-style-type: none"> <input type="checkbox"/> Aeronautical Engineering Jr. <input type="checkbox"/> Aircraft Engine Mechanic <input type="checkbox"/> Airplane Drafting <p>BUILDING</p> <ul style="list-style-type: none"> <input type="checkbox"/> Architecture <input type="checkbox"/> Arch. Drafting <input type="checkbox"/> Building Contractor <input type="checkbox"/> Estimating <input type="checkbox"/> Carpenter and Mill Work <input type="checkbox"/> Carpenter Foreman <input type="checkbox"/> Reading Blueprints <input type="checkbox"/> House Planning <input type="checkbox"/> Plumbing | <ul style="list-style-type: none"> <input type="checkbox"/> Heating <input type="checkbox"/> Painting Contractor <input type="checkbox"/> Air Conditioning <input type="checkbox"/> Electrician <p>BUSINESS</p> <ul style="list-style-type: none"> <input type="checkbox"/> Business Administration <input type="checkbox"/> Certified Public Accountant <input type="checkbox"/> Bookkeeping and Accounting <input type="checkbox"/> Office Management <input type="checkbox"/> Stenography and Typing <input type="checkbox"/> Secretarial <input type="checkbox"/> Federal Tax <input type="checkbox"/> Business Correspondence <input type="checkbox"/> Letter-writing Improvement <input type="checkbox"/> Personnel and Labor Relations <input type="checkbox"/> Advertising <input type="checkbox"/> Retail Business Management <input type="checkbox"/> Managing Small Business <input type="checkbox"/> Ocean Navigation <input type="checkbox"/> Sales Management <input type="checkbox"/> Short Story Writing <input type="checkbox"/> Creative Salesmanship <input type="checkbox"/> Traffic Management <p>CHEMISTRY</p> <ul style="list-style-type: none"> <input type="checkbox"/> Chemical Engineering <input type="checkbox"/> Chemistry <input type="checkbox"/> Analytical Chemistry | <ul style="list-style-type: none"> <input type="checkbox"/> Petroleum - Half Gas <input type="checkbox"/> Pulp and Paper Making <input type="checkbox"/> Plastics <p>CIVIL, STRUCTURAL ENGINEERING</p> <ul style="list-style-type: none"> <input type="checkbox"/> Civil Engineering <input type="checkbox"/> Structural Engineering <input type="checkbox"/> Surveying and Mapping <input type="checkbox"/> Structural Drafting <input type="checkbox"/> Highway Engineering <input type="checkbox"/> Reading Blueprints <input type="checkbox"/> Construction Engineering <input type="checkbox"/> Sanitary Engineering <p>DRAFTING</p> <ul style="list-style-type: none"> <input type="checkbox"/> Aircraft Drafting <input type="checkbox"/> Architectural Drafting <input type="checkbox"/> Electrical Drafting <input type="checkbox"/> Mechanical Drafting <input type="checkbox"/> Structural Drafting <input type="checkbox"/> Sheet Metal Drafting <input type="checkbox"/> Ship Drafting <input type="checkbox"/> Mine Surveying and Drafting <p>ELECTRICAL</p> <ul style="list-style-type: none"> <input type="checkbox"/> Electrical Engineering <input type="checkbox"/> Electrician <input type="checkbox"/> Electrical Maintenance | <ul style="list-style-type: none"> <input type="checkbox"/> Electrical Drafting <input type="checkbox"/> Electric Power and Light <input type="checkbox"/> Lineman <p>HIGH SCHOOL</p> <ul style="list-style-type: none"> <input type="checkbox"/> High School Subjects <input type="checkbox"/> Mathematics <input type="checkbox"/> Commercial <input type="checkbox"/> Good English <p>MECHANICAL AND SHOP</p> <ul style="list-style-type: none"> <input type="checkbox"/> Mechanical Engineering <input type="checkbox"/> Industrial Engineering <input type="checkbox"/> Industrial Supervision <input type="checkbox"/> Foremanship <input type="checkbox"/> Mechanical Drafting <input type="checkbox"/> Machine Design-Drafting <input type="checkbox"/> Machine Shop Practice <input type="checkbox"/> Tool Design <input type="checkbox"/> Industrial Instrumentation <input type="checkbox"/> Machine Shop Inspection <input type="checkbox"/> Reading Blueprints <input type="checkbox"/> Toolmaking <input type="checkbox"/> Gas-Electric Welding <input type="checkbox"/> Heat Treatment-Metallurgy <input type="checkbox"/> Sheet Metal Work <input type="checkbox"/> Sheet Metal Pattern Drafting <input type="checkbox"/> Refrigeration | <p>POWER</p> <ul style="list-style-type: none"> <input type="checkbox"/> Combustion Engineering <input type="checkbox"/> Diesel-Electric <input type="checkbox"/> Electric Light and Power <input type="checkbox"/> Stationary Steam Engineering <input type="checkbox"/> Stationary Fireman <p>RADIO, TELEVISION COMMUNICATIONS</p> <ul style="list-style-type: none"> <input type="checkbox"/> Practical Radio-TV Eng'ing <input type="checkbox"/> Radio Operating <input type="checkbox"/> Radio and TV Servicing <input type="checkbox"/> Television-Technician <input type="checkbox"/> Electronics <input type="checkbox"/> Telephone Work <p>RAILROAD</p> <ul style="list-style-type: none"> <input type="checkbox"/> Locomotive Engineer <input type="checkbox"/> Diesel Locomotive <input type="checkbox"/> Air Brakes <input type="checkbox"/> Car Inspector <input type="checkbox"/> Railroad Administration <p>TEXTILE</p> <ul style="list-style-type: none"> <input type="checkbox"/> Textile Engineering <input type="checkbox"/> Cotton, Rayon, Woolen Mfg. <input type="checkbox"/> Carding and Spinning <input type="checkbox"/> Warping and Weaving <input type="checkbox"/> Loom Fixing <input type="checkbox"/> Throwing <input type="checkbox"/> Finishing and Dyeing <input type="checkbox"/> Textile Designing |
|--|---|---|---|---|

Name _____ Age _____ Home Address _____

City _____ Zone _____ State _____ Working Hours _____ A.M. to P.M. _____

Occupation _____

Canadian residents send coupon to International Correspondence Schools Canadian, Ltd., Montreal, Canada. . . . Special tuition rates to members of the U. S. Armed Forces.



How YOU
can
**SAW
DRILL
GRIND
TURN
SAND**

with **SUPERSHOP**

5 BIG POWER TOOLS IN 1

• 8" TILTING TABLE SAW

- 1/2" DRILL PRESS
- 8" SANDER

When you DO-IT-YOUR-SELF with SUPERSHOP you save money and you have fun. You can build a house or a garage — handle BIG jobs. The 8 inch saw cuts 2 1/2 inches deep. Heavy tubular steel frame. 100% Ball Bearing. Lifetime accuracy. Save \$65.05—buy direct from factory. Take advantage of our FREE trial plan.

- 30" LATHE
- 5" GRINDER



DRILL PRESS



SANDER



LATHE



GRINDER

FACTORY
TO YOU

\$79.95

EASY PAY PLAN

POWER TOOLS INC. 157A Yates Ave.
Beloit, Wis.

Please send me your FREE How-to-Do-It Catalog.

NAME _____

ADDRESS _____

CITY _____ STATE _____

(Continued from page 8)

of that day and kerosene was cheaper than gasoline.

The few major improvements that Stanley did make in the last few models were indicative of the possibilities and if the engineers would take up from there, I believe with Mr. Orris that they could make today's methods of using steam look primitive in a very short time.

What the engineers are trying to accomplish today with automatic transmissions had already, in effect, been accomplished in the steam automobile of 30 years and more ago.

Glenn G. Smith,
Bellmore, N. Y.

To the Editor:

In your December 1953 issue is a letter from Ralph Hall of Seattle, Wash., who reminisces concerning a PM glider which he built and flew in 1909. While I am a much younger man, let it be known that PM inspired not only a first, but also a second

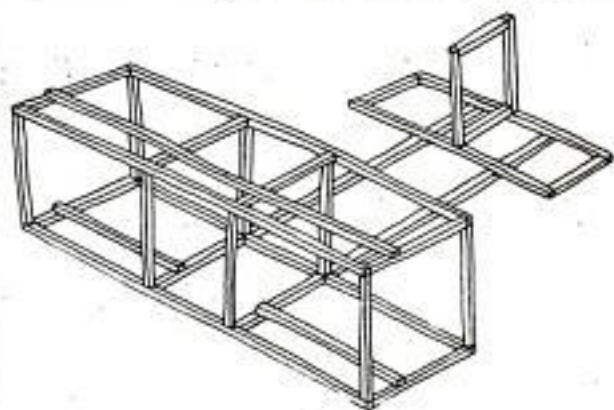

generation of embryo aviators. Unfortunately, I did not see your aviation issue of this year, but my father at one time bound a collection of his PMs and, as a child about 12, I came across this collection. In it was an article concerning the glider plans mentioned. Not having a set of the complete plans, nor the materials to make use of them, I was forced to improvise.

As you may well imagine, my glider was built under top secret conditions in order to provide an opportunity for test flight. The frame was nailed together and was made of 1-by-1-inch stock. It was covered with strawboard from shipping cartons because I had no other material and dared not ask for any. It was a one-day project from beginning to end. The frame was built as above, a design adapted to the materials at hand.

All went well until the moment of flight. At that time, my grandmother penetrated my screen of secrecy and saw me take off

(Continued to page 258)



I WILL TRAIN YOU AT HOME FOR GOOD PAY JOBS IN RADIO-TELEVISION

J. E. SMITH has trained more men for Radio-Television than any other man.

2 FREE BOOKS SHOW HOW MAIL COUPON

America's Fast Growing Industry Offers You

I TRAINED THESE MEN

LOST JOB, NOW HAS OWN SHOP
"Got laid off my machine shop job which I believe was best thing ever happened as I opened a full time Radio Shop. Business is picking up every week."—E. I. Slater, Corsicana, Texas.

GOOD JOB WITH STATION
"I am Broadcast Engineer at WLPN. Another technician and I have opened a Radio-TV service shop in our spare time. Big TV sales here... more work than we can handle."—J. H. Bengley, Suffolk, Va.

\$10 TO \$15 WEEK SPARE TIME
"Four months after enrolling for NRI course, was able to service Radios... averaged \$10 to \$15 a week spare time. Now have full time Radio and Television business."—William Weyde, Brooklyn, New York.

AVAILABLE TO VETERANS UNDER G.I. BILLS

WANT YOUR OWN BUSINESS?
Let me show you how you can be your own boss. Many NRI trained men start their own business with capital earned in spare time. Joe Travers, a graduate of mine from Asbury Park, N. J. says: "I've come a long way in Radio-Television since graduating. Have my own business on Main Street."

\$10 \$15 A WEEK EXTRA IN SPARE TIME

Many students make \$10, \$15 a week and more EXTRA fixing neighbors' Radios in spare time while learning. The day you enroll I start sending you SPECIAL BOOKLETS that show you how. Tester you build with kits I send helps you make extra money servicing sets, gives practical experience on circuits common to Radio and Television. All equipment is yours to keep.

A GOOD PAY JOB

NRI Courses lead to these and many other jobs: Radio and TV service, P.A., Auto-Radio, Lab, Factory, and Electronic Controls Technicians, Radio and TV Broadcasting, Police, Ship and Airways Operators and Technicians. Opportunities are increasing. The United States has over 115 million Radios—over 3000 Broadcasting Stations—more expansion is on the way.

A BRIGHT FUTURE

TV now reaches from coast-to-coast. 25 million homes now have Television sets; thousands more are being sold every week. About 200 TV stations are now on the air. Hundreds of others are being built. This means more jobs, good pay jobs with bright futures. More TV operators, installation, service technicians will be needed. Now is the time to get ready for success in TV.



You Practice Broadcasting with Equipment I Send



As part of my Communications Course I send you kits of parts to build the low-power Broadcasting Transmitter shown at left. You use it to get practical experience putting a station "on the air," perform procedures demanded of broadcasting station operators. An FCC Commercial Operator's License can be your ticket to a better job and a bright future. My Course gives the training you need to get your license.

You Practice Servicing with Equipment I Send

Nothing takes the place of PRACTICAL EXPERIENCE. That's why NRI training is based on LEARNING BY DOING. With my Servicing Course you build the modern Radio shown at right, a Multitester which you use to help fix sets while training. Many students make \$10, \$15 a week extra fixing neighbors' sets in spare time soon after enrolling. My book shows other equipment you get and keep.



Television Making Good Jobs, Prosperity

Training plus opportunity is the PERFECT COMBINATION for job security, good pay, advancement. In good times, the trained man makes the BETTER PAY, GETS PROMOTED. When jobs are scarce, the trained man enjoys GREATER SECURITY. Radio-TV needs men of action. NRI can provide the training you need for success in Radio-TV—for just a few hours of your spare time a week. But you must decide that you want success.

Mail for Actual Lesson and 64-page Book

Without obligating you in any way I'll send an actual lesson to prove that my training is practical, thorough. Also my 64-page book to show good job opportunities for you in Radio-TV. Terms for NRI training are as low as \$5 a month. Many graduates make more in two weeks than total cost of training. Mail coupon now. J. E. SMITH, President, National Radio Institute, Dept. 4CA, Washington 9, D. C. OUR 40TH YEAR.

Good for Both—FREE

MR. J. E. SMITH, President, Dept. 4CA
National Radio Institute, Washington 9, D. C.
Mail me Sample Lesson and 64-page Book, FREE.
(No salesman will call. Please write plainly.)

Name Age

Address

City Zone State

VETS write in date of discharge



New... All-Purpose Snips with PROTO Professional Quality!



MULTIPLE-LEVERAGE SNIPS

For daily use on intricate cutting jobs. Patented double compound action greatly increases power. Left, right, straight cut models.



DUCKBILL OR CIRCULAR SNIPS

Most popular style for professional cutting of circles, and other odd designs. Blades hollow ground for easier, faster, heavier work. In 7", 10" and 12" lengths.

COMBINATION SNIPS

Also favored by professional users for straight and moderately irregular cuts. Blades individually fitted to secure positive, free-cutting action. In 10" and 12" lengths.

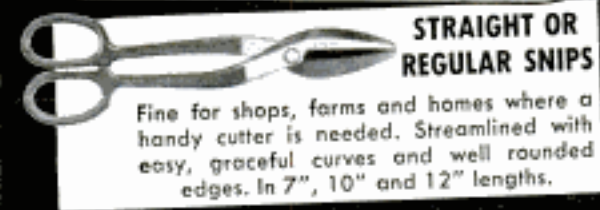

STRAIGHT OR REGULAR SNIPS

Fine for shops, farms and homes where a handy cutter is needed. Streamlined with easy, graceful curves and well rounded edges. In 7", 10" and 12" lengths.

Truly all-purpose, PROTO's new snips fill the needs of practically all industries, mechanics and craftsmen. Four basic styles cut hundreds of materials. And you get true professional

quality in PROTO snips! They give smooth, fast, accurate cuts... produce better finished work, clean and unbent... have great strength and toughness... are sturdily built. Buy these professional, all-purpose snips from your PROTO dealer. Send 10¢ for 68-page catalog of entire line to

The PROTO Line includes
Wrenches,
Pliers,
Screwdrivers,
Punches,
Chisels,
Sockets & Attachments,
Pullers,
Industrial Tools,
Many Others.

PLUMB TOOL COMPANY

2255Y Santa Fe Ave.,
Los Angeles 54, Calif.

Remember!
PROTO means
Professional
Tools



Eastern Factory—Jamestown, N.Y.

WHERE-TO-BUY-IT INDEX

Source of supply appears after items commercially available

AUTOMOTIVE

This year's crop of dream cars.....	88
Low-slung custom sport car built from 1948 Oldsmobile.....	101
American "snowmobile" ends need for dogs in Arctic (Highway Equipment Co., Inc., 616 D Ave., Cedar Rapids, Ia.).....	114
Willys' Aero Jeep matches speed and light weight of "Mighty Mite" (Kaiser-Willys, Toledo 1, Ohio).....	140
Jeep for mail carriers mounts steering wheel on the right (Willys Motor Inc., Toledo 1, Ohio).....	154
\$5,000 sport car has 205-horsepower engine, glass-fiber body (E. H. Edwards Co., South San Francisco, Calif., c/o Sterling Edwards).....	154

AUTOMOTIVE ACCESSORIES

Here's the long-life battery (Dr. L. Grant Hector, Sonotone Corp., Elmsford, N. Y.).....	98
Ceramic "towels" dry spark plugs (Lucas Products Co., P.O. Box 201, North Canton, Ohio).....	121

AVIATION

United States airlines set safety and traffic volume records.....	101
Air Force uses 10,000,000-candlepower light for night photos.....	141
British Sherpa airplanes headed for high places (British Information Service, 30 Rockefeller Plaza, New York 20).....	154
Aircraft fuel-weight indicator (Garco Corp., Sub. of General Aviation Corp., 540 E. 80th St., New York).....	242

CONSTRUCTION

Superheated welding rod melts stone and concrete (Chemotec Div., Eutectic Welding Alloys Corp., 40-40-172d St., Flushing, N. Y.).....	101
Lightweight building block is made of clay.....	120
Quartered skyscraper suspended from fins.....	144

HOUSE AND HOME

Home improvements: Light switch on door, alarm for boiling pot.....	122
Machine "plays records" to sew desired stitches (Necchi Distributors of Illinois, Inc., 515 W. Webster Ave., Chicago 14, Ill.).....	127
Electric switch mats placed under rugs set off burglar alarm (E. B. Hopkins, Hopkins Alarm System, 440 National Rd., Wheeling, W. Va.).....	140
Electric cooker (Knapp-Monarch Co., St. Louis 16, Mo.).....	142
Loaded brush (Hygienik Dishwasher Co., Inc., 354 W. 44th St., New York 36).....	142
Hair brush (Tek-Hughes Div., Johnson & Johnson, 2320 6th Ave., Watervliet, N. Y.).....	142
Silent switch (H. J. Theiler Corp., 22 Ashmont Ave., Whitinsville, Mass.).....	142
Timer (International Register Co., 2624 Washington Blvd., Chicago 12, Ill.).....	143
Cutlery tray (Plus-Tex Corp., 2525 Military Ave., Los Angeles 64, Calif.).....	143
Shelf supports (Target Products Co., P.O. Box 276, West Boyston, Mass.).....	143
Revolving shoe rack (Early Settlers, 93 E. 4th St., Brooklyn 18, N. Y.).....	143
Guard rails (Merit Housewares, 1687 McDonald Ave., Brooklyn 30, N. Y.).....	143
Revolving fireplace can throw heat to different parts of room (Mrs. Robert Thrun, Croton on Hudson, N. Y.).....	148
Plastic window frame offers more glass area (The Kohl Co., 701 Hickory St., Elkhart Lake, Wisc.).....	224

INDUSTRY

Rear-end pallet loader hoists bricks on truck (R. H. Berg, Port Costa Brick Co., Port Costa, Calif.).....	86
Begin first telephone cables to connect the hemispheres.....	115
Dye sprayed from pressure can finds flaws in metal (Franklin S. Catlin, Jr., 5960 Northwest Highway, Chicago 31, Ill.).....	127
Pipe clamp tightens to form seal around leaks and connections (Hobal Mfg. Co., P. O. Box 95, Bellerose 26, N. Y.).....	152
Giant drilling barge can sink well 30,000 feet deep (National Supply Co., 140 Stanwix St., Pittsburgh 22, Pa.).....	145
Self-loading truck picks up huge logs.....	128

MILITARY AND NAVAL

Heavy webbing muzzles bombers during pressurization tests (Lockheed Aircraft Corp., Marietta, Ga.).....	141
Navy's shipboard radar gauges speed of landing carrier planes (Raytheon Mfg. Co., Waltham, Mass.).....	155

SCIENCE

Skinner box tests rat IQs.....	16
Freezer aids surgery.....	86
Whirling magnetic drum classifies and remembers mail orders (John Plain & Co., 444 W. Washington, Chicago, Ill.).....	113
Heartbeats and brain waves telephoned to distant specialists (Cardiovascular Laboratory, College of Medicine, University of Nebr., Lincoln, Nebr.).....	139
Plants raised in radioactive atmosphere aid tracer studies.....	139
Radar spots cancer.....	254
Midget gyros to guide missiles.....	148

MISCELLANEOUS

Two headlights on power mower permit lawn cutting after dark (O. W. Davis Corp., Richmond, Ind.).....	86
Underwater bike propels submarine swimmer at rapid rate.....	113
Six-second loader for spraying planes.....	114

(Continued to page 14)

INVENTORS

Learn how to protect your invention. The U. S. Patent Laws provide that any new and useful art, machine, article of manufacture, or composition of matter, or any new and useful improvement thereof, may be patented if the act of invention is involved. Therefore, every inventor with a valuable invention should take advantage of the Patent Laws and proceed for patent protection in order to safeguard his rights.

A patent gives the inventor the exclusive right to prevent others from making, using, or selling the invention claimed in the patent for a period of seventeen years.

The Patent Laws were enacted for the benefit of the inventor to give him protection for the features of his invention which are patentable. These features must be properly and concisely set forth and claimed in a formal application for patent, in order to comply with the requirements of the Patent Laws. For that reason, unless the inventor is familiar with patent matters, he should engage a competent registered patent attorney or agent to represent him. We are registered to practice before the U. S. Patent Office and are prepared to serve you in the handling of your patent matters.

A specially prepared booklet entitled "Patent Guide for the Inventor", containing detailed information with respect to patent protection and procedure, together with a "Record of Invention" form will be promptly forwarded to you without obligation upon request.

CLARENCE A. O'BRIEN & HARVEY JACOBSON

Registered Patent Attorneys

41-C DISTRICT NATIONAL BUILDING
WASHINGTON 5, D. C.



THOUGHTS HAVE WINGS

You Can Influence Others With Your Thinking

TRY IT SOME TIME. Concentrate intently upon another person seated in a room with you, without his noticing it. Observe him gradually become restless and finally turn and look in your direction. Simple—yet it is a *positive demonstration* that thought generates a mental energy which can be projected from your mind to the consciousness of another. Do you realize how much of your success and happiness in life depend upon your influencing others? Is it not important to you to have others understand your point of view—to be receptive to your proposals?

How many times have you wished there were some way you could impress another favorably—*get across to him or her your ideas?* That thoughts can be transmitted, received, and understood by others is *now* scientifically demonstrable.

This FREE Book Points the Way

The tales of miraculous accomplishments of mind by the ancients are now known to be fact—not fable. The method whereby these things can be **INTENTIONALLY**, not accidentally, accomplished has been a secret long cherished by the Rosicrucians—one of the schools of ancient wisdom existing throughout the world. Write for the free copy of the fascinating sealed book, "THE MASTERY OF LIFE," which explains how you may receive this unique wisdom and benefit by its application. Address: Scribe D.B.F.

The ROSICRUCIANS

San Jose, (AMORC) California

USE THIS COUPON

Scribe D.B.F.
The Rosicrucians
San Jose, California

I am sincerely interested in an intelligent method of attaining a mastership of life. Send me without obligation, your FREE Book which explains how I may receive and use your age-old method.

Name.....
Address.....
City.....

(Continued from page 12)

Lightweight German streamliner has engines at front and back.....	121
Gigantic Japanese carp kite requires 200 anchor men.....	122
Midget diesel bike engine gets 300 miles per gallon (Newage International Inc., 235 E. 42d St., New York 17, N. Y.).....	122
Carrier model rides landlocked course on scooter wheels (George F. Kahne, 6828 Standish Drive, Radiant Valley, Md., Hyattsville P. O.).....	132
Curved meteor film (Eastman Kodak Co., 343 State St., Rochester 4, New York).....	139
Electronic nutcracker severs walnut halves without damage.....	139
Plastic drain unit features trap that unscrews without tools (Arthur S. LaPine & Co., 8601 S. Knox Ave., Chicago 29, Ill.).....	140
Electric massage chair lessens body fatigue (Niagara Mfg. and Distributing Corp., Adamsville, Pa.).....	144
Plywood chair on wheels aids crippled children (Harry P. Speer, 1612 3rd Ave., Council Bluffs, Iowa).....	144
Coated lamp repels insects (Duro-Test Corp., N. Bergen, N. J.).....	145
Expert predicts a big boost in Latin American population.....	145
Photoelectric cells grade eggs into six shade classifications (U. S. Dept. of Agriculture, Research Center, Beltsville, Md.).....	145
Thirty Irishmen with shillelaghs.....	146
Disposable mousetrap holds poisoned bait (Sanitary Plastic Trap Co., 46 E. Commerce St., Bridgeton, N. J.).....	146
Pocket calculator aids solution of trigonometry problems.....	148
Coliseum without girders (Alabama Agricultural Coliseum, Montgomery, Ala.).....	149
Fingerprint accompanies check (Digitab Inc., 704 W. Wisconsin Ave., Milwaukee Wisc.).....	155
Rubber raft scoots across ice or water to rescue drowning skater.....	155
Transparent typewriter bar aids typist in reading copy (Marroth Engineering Co., Wilton, Conn.).....	155
Mobile disaster unit carries rescue and first-aid equipment (Rollhome Co., Marshfield, Wis.).....	156

Craftsman and Shop Notes Index

AUTOMOTIVE

Plastic bottle used to spray water on dirty windshield.....	172
Lunch box hooks over car seat.....	173
Tracing car serial number.....	184
Sponge holds chamois flat when drying car.....	194
Test inner tube for tiny leaks with aid of hand wringer.....	214

BOATS

Slack on mooring lines of boat taken up by rubber band.....	163
Adjustable rower's seat for flat-bottom boat.....	192

FARM

Low-cost hinged "tractorport" stores simply by folding against barn wall.....	209
Frame covered with fencing keeps birds and eggs clean.....	216
Hanging of meat in smokehouse speeded by using hog rings.....	216

FISHING

Prevent spinning lures from kinking fishline.....	172
Rubber ball on fishing rod lessens hand fatigue.....	188
Matchbook cover holds flies in sportsman's hatband.....	188
Snag hook catches nibblers.....	192

LAWN AND GARDEN

Forms for concrete "stones" are discarded cooking pots.....	170
Wagon-wheel lawn bench adds beauty to yard.....	183
Buggy wheel is removable for mowing lawn.....	184
Hose section over hoe handle measures garden rows.....	183
Flowerpots on wagon wheel increase its useful beauty.....	192
Old railroad ties in garden add attractive rustic touch.....	192
Generator on power mower runs hedge clipper.....	214
Seed germination percentage.....	214

HOUSE AND HOME

Removing grease spots from rugs.....	163
Weighted drapes hang straight.....	173
Patching torn window screens.....	176
Projecting doorknobs replaced by recessed cabinet pull.....	178
Hook taken from fish's mouth with aid of vegetable tongs.....	184
Screen-wire pad removes labels on bottles and jars.....	184
Three-tiered plant holder.....	185
New faces for old ceilings.....	189
Floors given light wax coat.....	192
Storm sash and screens marked with carbon paper and die.....	194
Method for hanging screen door.....	196
Wrapping materials are dispensed through bottom of cabinet.....	196
"Kit" permits variety of bric-a-brac shelves.....	201

TOOLS

Die made of steel-rule stock cuts accurate duplicates.....	172
Cutter and ratchet screwdriver is substitute hand grinder.....	176
Oil-soaked sand keeps tools rust-free in damp location.....	176

(Continued to page 16)

IMPORTANT NOTICE—It is the intention of this magazine to provide its readers with information regarding the latest developments in the mechanical arts. We take no responsibility as to whether the disclosures contained in our articles are covered by patents and advise readers to investigate this subject before making, using, or selling any of the products, machines, or processes described in order to avoid possible liability for patent infringements.



10 Horsepower

JOHNSON
SEA-HORSE 10

GET *Action* FOR YOUR MONEY!

Ten horses give you action for your money. Ten horses give you a margin of power that lifts your boat into a plane with certainty every time—even with company along!

Here is man-size power—in a compact, easy-to-handle unit that speeds or trolls with equal facility. High-torque performance, the result of extremely advanced design, means terrific acceleration all the way up! If you're going after extra power, get the kind that counts. Ask the happy owners of Sea-Horse 10's!

HIGHLIGHTS: Equipped with full-size fuel system for long-range operation (6-gallon Mile-Master). Fitted for remote control of throttle, shift and steering. Twist-Grip Speed Control. Full Gear Shift. Air Intake Silencers. New Up-and-Off Motor Hood for instant engine accessibility. Only \$297.50 f.o.b. factory—outboard motoring's great buy!

FREE! The complete new 1954 Sea-Horse catalog. Write for it. See your Johnson Dealer. Look for his name under "Outboard Motors" in your classified phone book.

JOHNSON MOTORS
400 Pershing Road, Waukegan, Illinois
In Canada: Mfd. by Johnson Motors, Peterborough

THE NEW 1954 SEA-HORSES
ELECTRIC STARTING SEA-HORSE 25—25 hp. The "automatic" outboard. Everything deluxe!.....\$498.00*
SEA-HORSE 25—25 hp. Speeds over 30 mph! Yet it trolls!.....\$410.00*
SEA-HORSE 10—10 hp. New. Improved. Outboarder's great buy.....\$297.50*
SEA-HORSE 5½—5½ hp. New. "Suspension Drive." It's quiet!....\$210.00*
SEA-HORSE 3—3 hp. A 32-lb. twin! With Angle-matic Drive.....\$145.00*
SHIP-MASTER REMOTE CONTROL—Fits Sea-Horse 5½, "10" and both "25's." Instant hook-up. From.....\$29.50*

Johnson **SEA-HORSES**
FOR **DEPENDABILITY**



*Prices f.o.b. factory, subject to change. OBC certified brake hp at 4000 rpm. Weights approx.

67% MORE

Starting punch

**with this great
new super-powered
Double Eagle battery**



You'll get faster, surer starts these cold winter days with Goodyear's super battery—the new Double Eagle. That's because it has 67% more starting stamina than other batteries of its type.

But that's not all. The tremendous reserve power of the Double Eagle Dry-Proof Battery is even more than you need to supply heater, radio and a whole carload of accessories. And its superior plate insulation is highly resistant to acid, heat and pressure.

You'll recognize the super-powered Double Eagle by its sturdy, good-looking blue and yellow plastic case. Ask your dealer about this great new battery now. You'll find it well worth the extra money it costs.

Goodyear, Battery Dept., Akron 16, Ohio

GOODYEAR

DRY-PROOF DOUBLE EAGLE BATTERY

Double Eagle—T. M. The Goodyear Tire & Rubber Company, Akron, Ohio

MARCH 1954

1
Copyrighted material

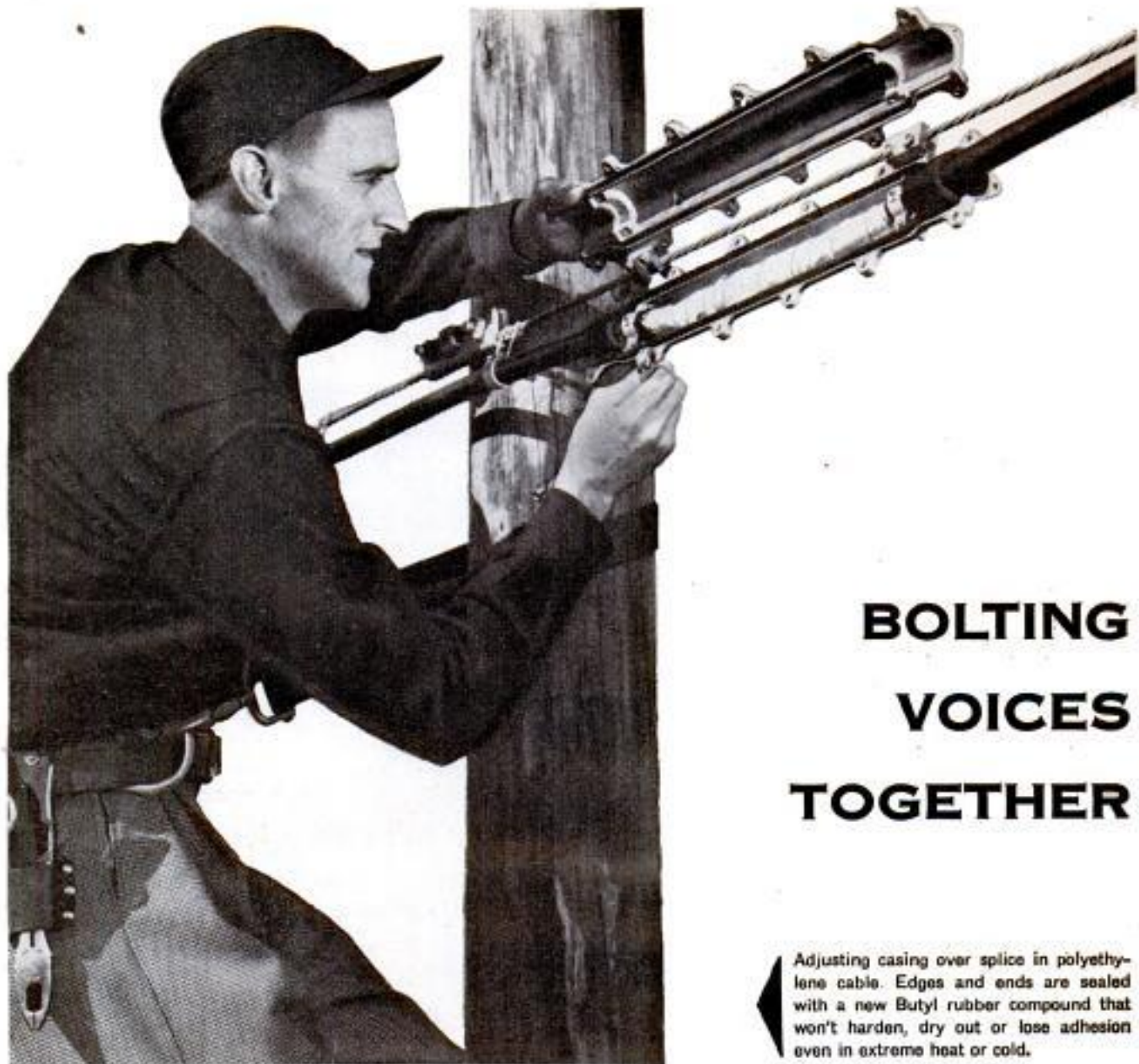

BOLTING VOICES TOGETHER

Adjusting casing over splice in polyethylene cable. Edges and ends are sealed with a new Butyl rubber compound that won't harden, dry out or lose adhesion even in extreme heat or cold.

More than ever, light, flexible polyethylene sheathed cable developed by Bell Telephone Laboratories is providing speedy answers to the demand for more telephone service.

But at thousands of splices, the sheath must be thoroughly sealed against moisture. Laboratories engineers developed a protective casing which is quickly and simply bolted in place. The edges and ends of the casing are *permanently* sealed with a new compound developed by Laboratories rubber chemists.

Now, economical polyethylene cable can be installed much faster and at lower cost. Here is another example of how Bell Laboratories continually finds ways to keep telephone service high in quality, while the cost stays low.

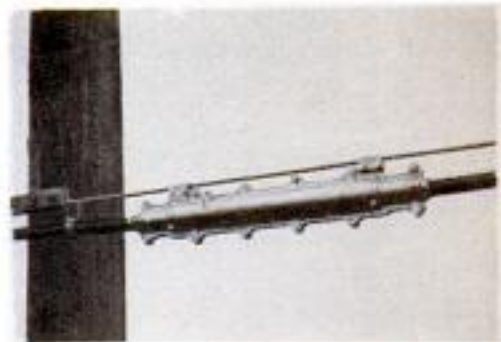

CLOSED CASING IN PLACE

BELL TELEPHONE LABORATORIES



Exploring and inventing, devising and perfecting, for continued improvements and economies in telephone service.

Popular Mechanics Magazine

Registered in U. S. Patent Office and Canada

H. H. WINDSOR, Founder

H. H. WINDSOR, JR., Editor and Publisher



this month's cover

TOO BAD we can't see the facial expressions of the two men on that high control tower. They probably have seen as many weird planes in the sky as anyone on earth, but we'll bet they're still startled when they see a black triangle streak past. This is just one of the odd-shaped aircraft — delta wings, swept wings, straight wings and others — under design in America's aircraft factories. These unconventional planes are tested at Edwards Air Force Base, Calif. The 140-foot tower is midway on the main runway. Eventually the runway will connect two dry-lake beds which have surfaces as hard as concrete. The lakes and the runway combined will provide a 22-mile-long strip, and even the fastest and weirdest of planes should find plenty of room there to land. What will be the shape of tomorrow's planes? A feature article starting on page 133 gives you a look at some odd shapes under test and some conclusions about the future

Published monthly by Popular Mechanics Company, 200 E. Ontario St., Chicago 11, Ill. H. H. Windsor, Jr., president; Wm. Harrison Feltz, exec. vice-pres.; D. F. Windsor, vice-president and secretary-treasurer; H. H. Windsor III, vice-president; Clover L. Perkins, advertising manager; Alan M. Deyoe, circulation manager. Single copy in the United States and Canada, 35 cents; subscription rates in the United States and possessions, Canada, Philippines and countries of the Pan-American Postal Union, 1 year \$3.00; 2 years, \$6.00; 3 years \$8.00. To all other countries and \$1.00 a year over United States prices for overseas postage. If you plan to move, notify us at least 30 days in advance so you will not miss an issue. Give us your old and new addresses. Entered as Second Class Matter, September 15, 1903, at the Post Office at Chicago, Illinois, under Act of March 3, 1879. Entered as Second Class Matter at Post Office Dept., Canada, Registered as Second Class Matter at the Post Office at Mexico, D. F., Mexico, June 20, 1950. Copyright 1953 by Popular Mechanics Company. Copyright under International Copyright Union. Copyright in France. All rights reserved under Pan-American Copyright Union. Printed in the United States of America.

Volume 101 MARCH 1954 Number 3

Address all communications to:
200 East Ontario Street, Chicago 11, Illinois

Managing Editor.....Roderick M. Grant
Assistant Managing Editor.....Wayne Whittaker
Shop Notes and Crafts Editor.....James R. Ward
Radio-Television, Electronics Editor.....Frank L. Brittin
Associate Editor, Aviation.....Aubrey O. Cookman, Jr.
Associate Editor.....Clifford B. Hicks
Associate Editor, Automotive.....Arthur R. Railton
Associate Editor, Shop Notes and Crafts.....Wayne C. Leckey
Assistant Editor, Shop Notes.....W. Clyde Lamme
Assistant Editor, Crafts.....Frank N. Stephany
Assistant Editor, Makeup.....John C. Dalen
Automotive Correspondent.....Leo Donovan
Art Director.....Frank Beatty

Assistant Editors

Leonard F. Hiltz Jay W. Hedden Elliott H. McCleary
Eastern Editor.....Richard F. Dempwolff
Empire State Bldg., Room 2906, New York City 1
Western Editor.....Thomas E. Stimson, Jr.
London Manager.....Douglas W. Wedderspoon
Eagle House, Jermyn St., London S. W. 1, England
Director, Bureau of Information.....Allan Carpenter
200 E. Ontario St., Chicago 11

IN THIS ISSUE

Mel Koontz Twists Tigers' Tails	81
Owners Report on the '54 Chrysler	92
How to Produce New Ideas	102
Pipe-Line Archeologists	110
"Jimmy" Engines for Extra Horsepower	116
The Sub That Can Lick a Plane	123
Bedside Radio Network	129
The Shape of Tomorrow's Planes	133
What's New for Your Home	142
Where to Find Fish in a Stream	150
Radio, TV and Electronics	157

For the Craftsman

Martin Motel	161
Here Come the Outboards—Part I	164
Color-Size Your Home	177
New Faces for Old Ceilings	189
Know Your Cooling System	197
Modeling the Midway—Part III	202
Flame Soldering	210
Shopping for Tools	218

Other items, and manufacturers of available products described, are listed on pages 12, 14 and 16

Texaco Tips

How to keep your air filter clean

If your carburetor air filter is clogged with road grit and grime, it cannot perform its necessary function. The result? —your engine suffers from metal-wearing matter. To keep it clean, free from clogging sediment, see your Texaco Dealer. If necessary, he will remove the filter element and wash it thoroughly in kerosine. Oil bath type filters will get an oil change to the right seasonal grade, as needed. Extra care like this helps keep your car running better and running longer.



How to get that "cushiony" ride

Note the tight-clinging "collar" of Marfak lubricant on the front suspension. Marfak stays on the job far longer. It's extra-stretchy... forms a tough protective coating between points of friction and wear. With Marfak, you enjoy 1,000 miles or more of *cushiony* smooth motoring. Your Texaco Dealer lubricates your car by chart, never by chance. His lubrication guides include instructions for every make and model of car. Today, get Marfak lubrication. See your Texaco Dealer... the best friend your car has ever had.

THAT "CUSHIONY" FEELING LASTS LONGER WITH



THE TEXAS COMPANY
TEXACO DEALERS
in all 48 states

Texaco Products are also distributed in Canada and in Latin America

TUNE IN: METROPOLITAN OPERA radio broadcasts every Saturday afternoon. See newspaper for time and station.

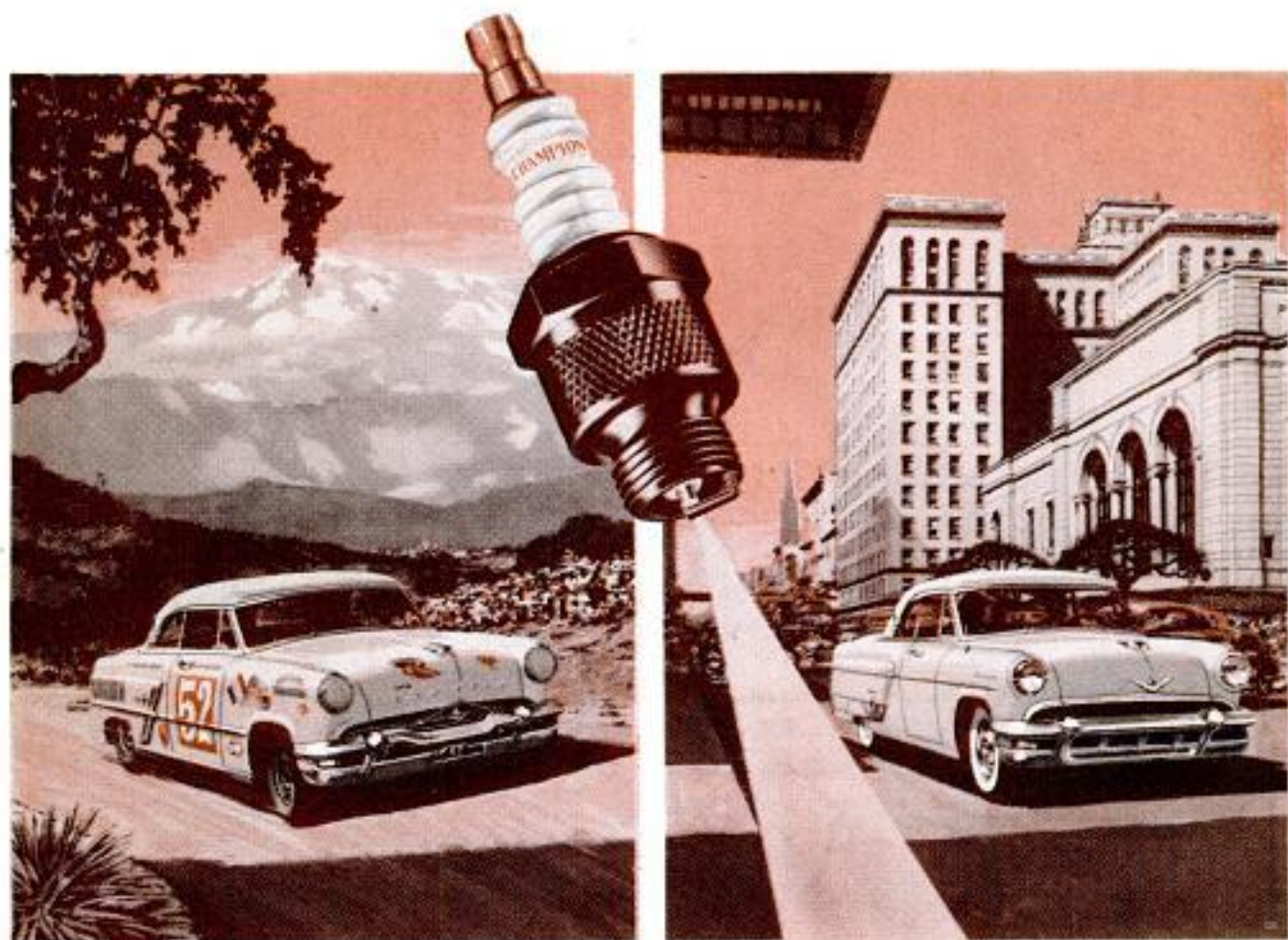

MEXICAN ROAD RACE OR HOMETOWN TRAFFIC, YOU'RE AHEAD WITH CHAMPION SPARK PLUGS!

Today, because of higher compressions, good spark plugs are the key to top engine performance. With sweeping victories in the Mexican Road Race, Champion Spark Plugs *once again* prove their outstanding superiority under extreme driving conditions. Champions came through this gruelling 1,912-mile run with dependability and performance to spare—powering the winning Lincolns in the large stock class, the winning Lancia in the large sports class and the Chevrolet, winner of the small stock class. These were strictly stock Champions, identical with those available at your neighborhood dealer.

CHAMPION SPARK PLUG COMPANY, TOLEDO 1, OHIO

ANOTHER CHAMPION FEATURE



CHAMPIONS

WILL MAKE ANY CAR RUN BETTER!

This One



Q5CJ-HS8-FWQP

MARCH 1954

Copyrighted material 5

NOW YOU CAN BUILD IT WITH CONCRETE BLOCKS

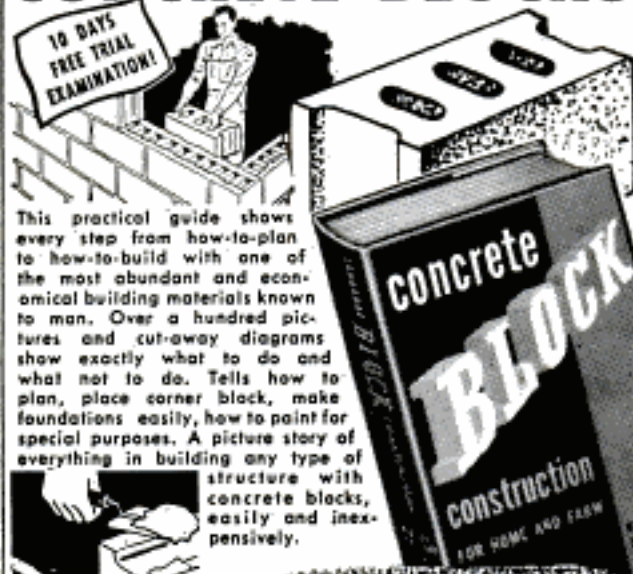

This practical guide shows every step from how-to-plan to how-to-build with one of the most abundant and economical building materials known to man. Over a hundred pictures and cut-away diagrams show exactly what to do and what not to do. Tells how to plan, place corner block, make foundations easily, how to paint for special purposes. A picture story of everything in building any type of structure with concrete blocks, easily and inexpensively.

Here's how to apply Mortar

Here's how little this book costs you . . . or if you don't keep it after 10 days trial, return it and you owe nothing. **\$3.25**

CARPENTRY FOR EVERYONE



A clear explanation of modern carpentry construction including framing, roof constructions, general carpentry work, exterior and interior finish of buildings, building forms and working drawings, and farm buildings. Covers everything you need to know about lumber, tools, joints and splices, floors, stairs, partitions, rafters, etc. Gives short cuts and tricks used by the master carpenter. Easy to understand. 504 pages, 580 illustrations. **\$2.50.** Use 10 day no-cost trial coupon below.

BRICKLAYING — WIRING — PLUMBING

Bricklaying Skill and Practice shows by clear explanations and actual on-the-job illustrations, simplifies the construction of everything from fireplaces to complete buildings. **\$3.25**
Electric Wiring—New book covers job-tested methods of residential and farm wiring, code changes. Show-how for amateur, valuable reference for tradesman, estimator, contractor. **\$4.25**
How to Design and Install Plumbing—Hundreds of how-to-do-it pictures, full-sized blueprints for most every plumbing job. 349 illustrations, 422 pages. **\$4.25**

OTHER YOU-CAN-DO-IT BOOKS IN COUPON BELOW

Mail this coupon today—10 days trial at no cost to you
 American Technical Society, Dept. B-319
 848 East 58th Street, Chicago 37, Illinois

Please rush me the following books I'm checking below to examine at home. If I'm not convinced these books will help me save thousands of dollars by doing my own building and planning, I may return the books and owe nothing.

- | | | | |
|---------|--------------------------|--|--------|
| Examine | <input type="checkbox"/> | CONCRETE BLOCK CONSTRUCTION FOR HOME AND FARM..... | \$3.25 |
| | <input type="checkbox"/> | CARPENTRY..... | \$2.50 |
| at home | <input type="checkbox"/> | BRICKLAYING...Skill and Practice... | \$3.25 |
| | <input type="checkbox"/> | HOW TO DESIGN AND INSTALL PLUMBING..... | \$4.25 |
| at no | <input type="checkbox"/> | ELECTRIC WIRING— | |
| cost. | <input type="checkbox"/> | Residential and Farm..... | \$4.25 |
| | <input type="checkbox"/> | How to Insulate Home & Farm Bldgs... | \$3.25 |
| | <input type="checkbox"/> | Steel Square..... | \$2.50 |

Name _____

Address _____

City _____ State _____

- Ten day no-cost-trial. If I keep books, will remit by check or money order.
 Send C.O.D. Same return privilege—money refunded.
 I'm enclosing \$_____ now to save postage—same return privilege—money refunded.

in this corner..... THE EDITORS



ART RAILTON
 AUTOMOTIVE EDITOR
 POPULAR MECHANICS, CHICAGO

CONGRATULATIONS ON EXCELLENT PRESENTATION OF CLASSIC CARS IN FEBRUARY ISSUE. YOU HAVE HONORED A GREAT ERA AND A DISTINGUISHED COLLECTION OF FINE CARS. SEVERAL CLUB MEMBERS WANT TO KNOW HOW THEY CAN GET REPRINTS OF THESE COLOR PICTURES. ARE THEY AVAILABLE?

GORDON WEBBER, PRESIDENT
 CLASSIC CAR CLUB OF AMERICA
 122 CEDAR STREET NEW YORK NY

A limited number of reprints of the album of Classic Cars, printed in full color on one side only, is available for mailing on receipt of 10 cents per set to cover handling. Address requests to the Bureau of Information, 200 E. Ontario St., Chicago 11.

—The Editor.

To the Editor:

Your article on "Perpetual Motion Just Isn't" (Jan. 1953) is interesting. I was reminded that the various ideas for perpetual motion are just about as practical and sensible as one my physics professor used to give to his classes. The idea is illustrated by the accompanying sketch.

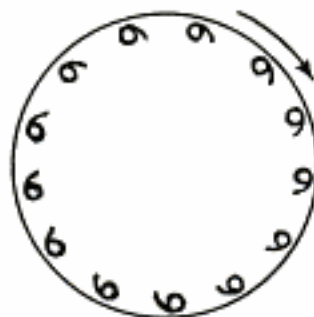

On the rim of a mounted wheel the figure six is placed at frequent intervals. However, on the right side the figures became nines. Nine being heavier than six, the wheel rotates as shown.

B. E. Kimble
 (Retired teacher)
 Morgantown, W. Va.

To the Editor:

Congratulations on your article "Trailers Are Stay-at-Homes Now" (PM, Dec. 1953).

Having lived in trailers for seven years, I am very much interested in trying to prove to the average person that a trailer makes an excellent place to live. I'm sure all trailerites feel that you have aided our cause in fighting the prejudice people have against trailers.

(Continued to page 8)

GOOD SALARY **FINE CAR** **A NICE HOME** **BANK ACCOUNT**

**To the man who wants to enjoy
an ACCOUNTANT'S CAREER**

FREE SAMPLE LESSON

IF you're that man, here's something that will interest you.

Not a magic formula—not a get-rich-quick scheme—but something more substantial, more practical.

Of course, you need something more than just the desire to be an accountant. You've got to pay the price—be willing to study earnestly, thoroughly.

Still, wouldn't it be worth your while to sacrifice some of your leisure in favor of interesting home study—over a comparatively brief period? Always provided that the rewards were good—a salary of \$4,000 to \$10,000?

An accountant's duties are interesting, varied and of real worth to his employers. He has *standing!*

Do you feel that such things aren't for you? Well, don't be too sure. Very possibly they *can* be!

Why not, like so many before you, investigate LaSalle's modern Problem Method of training for an accountancy position?

Just suppose you were permitted to work in a large accounting house under the personal supervision of an expert accountant. Suppose, with his aid, you studied accounting principles and solved problems day by day—easy ones at first—then more difficult ones. If you could do this—and could turn to him for advice as the problems became complex—soon you'd master them all.

That's the training you follow in principle under the LaSalle Problem Method.

You cover accountancy from the basic Principles right up through Accountancy Systems and Income Tax Procedure. Then you add C. P. A. Training and prepare for the C. P. A. examinations.

As you go along, you absorb the principles of Auditing, Cost Accounting, Business Law, Statistical Control, Organization, Management and Finance.

Your progress is as speedy as you care to make it—depending on your own eagerness to learn and the time you spend in study.

Will recognition come? The only answer, as you know, is that success *does* come to the man who is really *trained*. It's possible your employers will notice your improvement in a very few weeks or months. Indeed, many LaSalle graduates have paid for their training—with increased earnings—before they have completed it! For accountants, who are trained in organization and management, are the executives of the future.

**Get Free Sample Lesson—Also
"Accountancy, The Profession That Pays"**

For your own good get all the facts. Write for Free Sample Lesson—also 48-page book "Accountancy, The Profession That Pays." They will prove that Accountancy offers brilliant futures to those who aren't afraid of serious home study, and

will show the wide range of opportunities that exist today. No cost or obligation. If you want a position of higher income, greater prestige and professional standing... MAIL THE COUPON NOW!

**Over 4,000 Certified
Public Accountants among
LaSalle alumni**



**LASALLE EXTENSION UNIVERSITY
A CORRESPONDENCE INSTITUTION**

417 S. Dearborn St., Dept. 364HR Chicago 5, Ill.

I want to be an accountant. Send me without obligation, Free Sample Lesson—also "Accountancy, The Profession that Pays."

Name.....Age.....
Address.....
City, Zone & State.....



B.F. Goodrich
ASPHALT
 FLOOR TILE



**2 THINGS
 SOLD ME!**

(Continued from page 6)



I own a two-story Ventoura, so I was able to detect a slight error on the length of the trailer. The length is 44 feet, instead of 41 feet. I'm enclosing a snapshot of my trailer. The Crosley is mine, too. Would anyone need any more proof that "Trailers Are Stay-at-Homes Now"?

David S. Eicher,
 Airbase Trailer Park,
 Route 5,
 Columbus, Miss.

To the Editor:

I would like to comment on the remarks of Mr. Orris in his letter published on page 10 of December (1953) *Popular Mechanics* regarding the gas-turbine truck experiment in the West and the problem of fuel consumption and noise to be overcome.

Mr. Orris has a good question regarding steam as a method of propulsion for trucks, although I don't know why he mentions only trucks. Why not passenger cars as well?

There is something about American ingenuity that drives it toward the greatest obstacles rather than in the line of least resistance. It is my firm conviction that if as much money and effort had been applied to the development of the steam engine for automotive power as was to the internal-combustion engine, that steam would dominate the scene today.

My first car was a 1910 Stanley Steamer; the next was a popular car with internal-combustion engine and a cone clutch. I was so disgusted with the slip-grab clutch problem that I got another Steamer and, except for the delay attendant to firing up, it was far superior to the internal-combustion cars of the day. The Stanley brothers were just beginning to wake up to the fact they must "get up-to-date" if they were to compete, when they went out of business. The simplicity of the steam engine was very important, repairs easily made. Power was available at the wheels, no clutch or automatic transmission to cope with.

Noise? Very quiet. Fuel consumption? Lower than the internal-combustion jobs

(Continued to page 10)

**The EASE of
 Doing it!**



My dealer told me how to install this beautiful, long-lasting floor tile. It's easy to do with the B. F. Goodrich installation kit.

The SAVINGS!

I saved plenty by doing it myself . . . the results are something to be proud of. Send for FREE full color folder.



B. F. Goodrich Co., Dept. PM3,
 Flooring Div., Watertown 72, Mass.

NAME.....

ADDRESS.....

CITY.....STATE.....

Tomorrow's leaders are busy tonight

Lighted windows and burning ambitions. The two go together. And with them, in over 100,000 cases, go the teaching texts of the International Correspondence Schools. These men are studying to be tomorrow's foremen and supervisors, department heads and office managers. Let I. C. S. show you how you can join them. Simply mark and mail the coupon. It brings full information.



I. C. S., Scranton 9, Penna.

INTERNATIONAL CORRESPONDENCE SCHOOLS

ICS

BOX 5614-L, SCRANTON 9, PENNA.

Without cost or obligation, send me "HOW to SUCCEED" and the booklet about the course BEFORE which I have marked X:

- | | | | | |
|--|---|--|---|--|
| <p>ART</p> <ul style="list-style-type: none"> <input type="checkbox"/> Commercial Art <input type="checkbox"/> Magazine Illustrating <input type="checkbox"/> Fashion Illustrating <input type="checkbox"/> Cartooning <input type="checkbox"/> Sketching and Painting <input type="checkbox"/> Show Card and Sign Lettering <p>AUTOMOTIVE</p> <ul style="list-style-type: none"> <input type="checkbox"/> Automobile, Mechanic <input type="checkbox"/> Auto Elec. Technician <input type="checkbox"/> Auto Body Rebuilding and Refinishing <p>Diesel—Gas Engines</p> <p>AVIATION</p> <ul style="list-style-type: none"> <input type="checkbox"/> Aeronautical Engineering Jr. <input type="checkbox"/> Aircraft Engine Mechanic <input type="checkbox"/> Airplane Drafting <p>BUILDING</p> <ul style="list-style-type: none"> <input type="checkbox"/> Architecture <input type="checkbox"/> Arch. Drafting <input type="checkbox"/> Building Contractor <input type="checkbox"/> Estimating <input type="checkbox"/> Carpenter and Mill Work <input type="checkbox"/> Carpenter Foreman <input type="checkbox"/> Reading Blueprints <input type="checkbox"/> House Planning <input type="checkbox"/> Plumbing | <ul style="list-style-type: none"> <input type="checkbox"/> Heating <input type="checkbox"/> Painting Contractor <input type="checkbox"/> Air Conditioning <input type="checkbox"/> Electrician <p>BUSINESS</p> <ul style="list-style-type: none"> <input type="checkbox"/> Business Administration <input type="checkbox"/> Certified Public Accountant <input type="checkbox"/> Bookkeeping and Accounting <input type="checkbox"/> Office Management <input type="checkbox"/> Stenography and Typing <input type="checkbox"/> Secretarial <input type="checkbox"/> Federal Tax <input type="checkbox"/> Business Correspondence <input type="checkbox"/> Letter-writing Improvement <input type="checkbox"/> Personnel and Labor Relations <input type="checkbox"/> Advertising <input type="checkbox"/> Retail Business Management <input type="checkbox"/> Managing Small Business <input type="checkbox"/> Ocean Navigation <input type="checkbox"/> Sales Management <input type="checkbox"/> Short Story Writing <input type="checkbox"/> Creative Salesmanship <input type="checkbox"/> Traffic Management <p>CHEMISTRY</p> <ul style="list-style-type: none"> <input type="checkbox"/> Chemical Engineering <input type="checkbox"/> Chemistry <input type="checkbox"/> Analytical Chemistry | <ul style="list-style-type: none"> <input type="checkbox"/> Petroleum—Nat'l Gas <input type="checkbox"/> Pulp and Paper Making <input type="checkbox"/> Plastics <p>CIVIL, STRUCTURAL ENGINEERING</p> <ul style="list-style-type: none"> <input type="checkbox"/> Civil Engineering <input type="checkbox"/> Structural Engineering <input type="checkbox"/> Surveying and Mapping <input type="checkbox"/> Structural Drafting <input type="checkbox"/> Highway Engineering <input type="checkbox"/> Reading Blueprints <input type="checkbox"/> Construction Engineering <input type="checkbox"/> Sanitary Engineering <p>DRAFTING</p> <ul style="list-style-type: none"> <input type="checkbox"/> Aircraft Drafting <input type="checkbox"/> Architectural Drafting <input type="checkbox"/> Electrical Drafting <input type="checkbox"/> Mechanical Drafting <input type="checkbox"/> Structural Drafting <input type="checkbox"/> Sheet Metal Drafting <input type="checkbox"/> Ship Drafting <input type="checkbox"/> Mine Surveying and Drafting <p>ELECTRICAL</p> <ul style="list-style-type: none"> <input type="checkbox"/> Electrical Engineering <input type="checkbox"/> Electrician <input type="checkbox"/> Electrical Maintenance | <ul style="list-style-type: none"> <input type="checkbox"/> Electrical Drafting <input type="checkbox"/> Electric Power and Light <input type="checkbox"/> Lineman <p>HIGH SCHOOL</p> <ul style="list-style-type: none"> <input type="checkbox"/> High School Subjects <input type="checkbox"/> Mathematics <input type="checkbox"/> Commercial <input type="checkbox"/> Good English <p>MECHANICAL AND SHOP</p> <ul style="list-style-type: none"> <input type="checkbox"/> Mechanical Engineering <input type="checkbox"/> Industrial Engineering <input type="checkbox"/> Industrial Supervision <input type="checkbox"/> Foremanship <input type="checkbox"/> Mechanical Drafting <input type="checkbox"/> Machine Design-Drafting <input type="checkbox"/> Machine Shop Practice <input type="checkbox"/> Tool Design <input type="checkbox"/> Industrial Instrumentation <input type="checkbox"/> Machine Shop Inspection <input type="checkbox"/> Reading Blueprints <input type="checkbox"/> Toolmaking <input type="checkbox"/> Gas—Electric Welding <input type="checkbox"/> Heat Treatment—Metallurgy <input type="checkbox"/> Sheet Metal Work <input type="checkbox"/> Sheet Metal Pattern Drafting <input type="checkbox"/> Refrigeration | <ul style="list-style-type: none"> <input type="checkbox"/> Combustion Engineering <input type="checkbox"/> Diesel—Electric <input type="checkbox"/> Electric Light and Power <input type="checkbox"/> Stationary Steam Engineering <input type="checkbox"/> Stationary Fireman <p>RADIO, TELEVISION COMMUNICATIONS</p> <ul style="list-style-type: none"> <input type="checkbox"/> Practical Radio—TV Eng'ring <input type="checkbox"/> Radio Operating <input type="checkbox"/> Radio and TV Servicing <input type="checkbox"/> Television—Technician <input type="checkbox"/> Electronics <input type="checkbox"/> Telephone Work <p>RAILROAD</p> <ul style="list-style-type: none"> <input type="checkbox"/> Locomotive Engineer <input type="checkbox"/> Diesel Locomotive <input type="checkbox"/> Air Brakes <input type="checkbox"/> Car Inspector <input type="checkbox"/> Railroad Administration <p>TEXTILE</p> <ul style="list-style-type: none"> <input type="checkbox"/> Textile Engineering <input type="checkbox"/> Cotton, Rayon, Woolen Mtg. <input type="checkbox"/> Carding and Spinning <input type="checkbox"/> Warping and Weaving <input type="checkbox"/> Loom Fixing <input type="checkbox"/> Throwing <input type="checkbox"/> Finishing and Dyeing <input type="checkbox"/> Textile Designing |
|--|---|--|---|--|

Name _____ Age _____ Home Address _____

City _____ Zone _____ State _____ Working Hours _____ A.M. to P.M. _____

Occupation _____

Canadian residents send coupon to International Correspondence Schools Canadian, Ltd., Montreal, Canada, . . . Special tuition rates to members of the U. S. Armed Forces.

DRAFTSMEN



**EARN
BIG MONEY!**

Want more money? Steady employment? Clean, interesting work? Look into Drafting. You'll quickly see why there's real opportunity, more money in this prosperous professional-type work. Want ads show trained draftsmen are in great demand. Find out how you can qualify in a few months for a good job in Drafting.

**LEARN IN SPARE TIME—AT HOME
(or at the College in Chicago)**

A few hours of pleasant home study every week—that's all. All the tools you need to train at home; valuable drawing outfit included. For 50 years this nationally famous school has prepared men quickly for good positions in industry.

FREE INFORMATION—SEND COUPON

Find out how C.T.C. practical training has boosted the pay for hundreds, what it can do for you. Learn what Chicago Tech graduates say about their work, earnings, success. Don't wait! Investigate now. Send for this **FREE TRIAL LESSON**. No charge for this lesson, now or later. Fill out and mail coupon or send post card today.



**CHICAGO
TECHNICAL COLLEGE**

C-252 Tech Bldg., 2000 So. Michigan Ave.
Chicago 16, Illinois

Mail me **FREE Lesson** with information about big opportunities in **DRAFTING**.

NAME.....AGE.....
ADDRESS.....
CITY.....ZONE.....STATE.....

(Continued from page 14)

Jig assures accurate sanding of miter cuts on molding.....	185
Plane-iron sharpening jig is made from wood scraps.....	201
Lever-action tenoning jig.....	207
Grinding jig for lathe chisels.....	215
Glass cutter held in lathe tool post scores bottles accurately.....	217
Lathe center with driving pin for machining small-diameter work.....	217
"Tow bar" is quickly improvised from pipe and chain.....	217

WORKSHOP HINTS

Turn button on workbench aligns boards for marking.....	163
Waste piece from curved cut used as sanding block.....	170
Small objects "clamped" in clay while soldering joints.....	172
Sharpen scissors on circular saw.....	182
Wire-solder dispenser.....	184
Plan of the month—Chaise longue.....	186
Hinged stop on miter gauge of circular saw eliminates waste.....	194
Insulation "brushed" from wire.....	194
Seak tools to remove rust.....	194
Outboard motor stored on bracket fastened to exposed stud.....	196
Accurately aligning dowel holes requires only carbon paper.....	214
Drill-press clamping kink.....	216
Machinist's layout white.....	216
Handle for carrying vise.....	217

MISCELLANEOUS

Postage stamps carried conveniently inside pen barrel.....	163
Cane-woven hot pad.....	170
Papers held by envelope flap when stapling several sheets.....	172
File for 35-mm. transparencies made from photo-paper carton.....	173
Paper-and-paraffin starters ideal for outdoor fire use.....	176
Flashing grade-crossing signals for toy trains.....	183
Transfer pictures decorate photograph.....	183
Power for electric shaver supplied by dry-cell battery.....	188
Reflector surfaces renewed with reflective beads.....	188
Waterproof your hunting boots.....	188
Things to do with milk cartons.....	193
Electro-etched name plates.....	195
Rear sight on gun painted red to improve accuracy of aim.....	196
Pillow kept on camp cot by removable headboard.....	201
Securing temporary wire fencing.....	206
Clothespins provide leveling wedges for resilvering mirrors.....	209
Wire-solder hook assures submerging of pail in cistern.....	209
Keeping water warm in pail.....	214
Inking device on pantograph utilizes refill cartridge.....	216

Radio-Television, Electronics

For the sake of the record (The Tedrad Company, 62 St. Mary's Street, Yonkers 2, New York).....	197
1954 "Little giant" low-cost multistation intercom system.....	158
Back-loaded cabinet for super-fidelity home phono.....	160

Skinner Box Tests Rat IQ

Electronic recording equipment keeps score as rats take intelligence tests at Pomona College, Calif. Three metal bars projecting into the testing chamber are connected to an automatic timer and a series of counters which record the rat's learning behavior. If the rat touches one bar, he is rewarded with a drink of water. Another bar produces an electric shock, and one can be wired to flash a light.



INVENTORS

If you believe that you have an invention, you should find out how to protect it. The first step is to have a search made of the prior pertinent U. S. patents. If a report on this search indicates that the invention appears patentable you can apply for a patent, and the specifications and claims should be prepared.

The firm of McMorrow, Berman & Davidson, with offices in Washington, D. C., is qualified to take the necessary steps for you. We can make a preliminary search on your invention, advise you whether we think it can be patented, and prepare your application for patent.

Unless you are fully familiar with the U. S. Patent Laws, we recommend that you engage the services of a Registered Patent Attorney to protect your interests. The patent laws are *your* laws. A patent gives you the right to prevent others from making, using or selling the invention claimed in your patent for a period of 17 years.

Use these patent laws for your protection. Investigate whether your invention can be patented. If you have what you believe to be an invention, we suggest that you have this firm make a search for you.

Send for a copy of our Patent Booklet entitled "How To Protect Your Invention," containing information about patent protection and patent procedure. Along with this we will also send you an "Invention Record" form, for your use in writing down and sketching details of your invention. We will mail them promptly. No obligation. They are yours for the asking.

McMORROW, BERMAN & DAVIDSON

Registered Patent Attorneys

PATENTS • COPYRIGHTS • PATENTS

135-Z VICTOR BUILDING, WASHINGTON 1, D. C.

Are you an "Ideal" male?

What do women say about men privately? 100 models—real "pin-up" girls, gave the answer. To be an "Ideal Male," they said, demands the qualities below. If you have them *all* your score is 100:

SCORE YOURSELF

- | | |
|--|-------------|
| — A "he-man"—but not a "cave-man" | (20 points) |
| — Ambitious—but not a grind | (20 points) |
| — Sociable—good talker and mixer | (15 points) |
| — Good looking—but not too handsome | (20 points) |
| — Most important, well-groomed hair kept neat without messy goo* | (25 points) |

***Amazing new "no grease" discovery keeps hair neater than gooey oils, creams—keeps hair and scalp cleaner, too!**

To "up" your score as an "Ideal" Male use Fitch Ideal—the hair tonic that helps keep hair good-looking, neat all day...*cleaner*, too! Not sticky or creamy, it won't trap dirt to clog scalp pores. And its tonic action relieves itching, acts to keep scalp free of flaky dandruff.

FITCH *Ideal* HAIR TONIC

WELL GROOMED?
IS HE GOOD LOOKING?
IS HE AMBITIOUS?



At drug counters. And ask Barbers for professional applications.



SAY YOU SAW IT IN POPULAR MECHANICS

You Can Play



... even if you don't know a single note of music now!

IMAGINE! Even if you never dreamed you could play... you can soon surprise your friends with your musical ability. No special talent or previous training needed. Spend just a few minutes a day—and only a few cents per lesson. Teach yourself to play piano, guitar, accordion, whatever instrument you choose. Make amazingly rapid progress because you start right out playing real pieces by note. No boring exercises to do. Over 900,000 people have chosen this easy home study method.

FREE BOOK and FREE LESSON-SAMPLE

See actual proof that YOU can play. Mail coupon for FREE BOOK and Lesson-Sample to: U. S. SCHOOL OF MUSIC, Studio 303, Port Washington, N. Y. (1946 SUCCESSFUL YEAR)



U. S. SCHOOL OF MUSIC, Studio 303, Port Washington, N. Y.

Please send me Free Book and Free Lesson-Sample.

I'm interested in playing (name instrument) _____

I do I do NOT—have instrument now.

Name _____

Address _____ (please print)

18

FREE TO SADDLE HORSE OWNERS

Why pay fancy prices for saddlery? Write for FREE Catalog that has saved real money for thousands of horsemen. Describes over 400 popular items of English and American "tack." I ship saddlery on approval. Write today.



"little joe" WIESENFELD

Dept. 83

Baltimore 1, Maryland



AUTO WASHER

Your car sparkling clean—in a jiffy—magic "sponge" cleaning-cloth. Simply glide over car. PRESTO! Dust, grease, dirt, grime disappear like magic. Your car gleams like a mirror. Take orders! Make money!

SAMPLES for TRIAL

Sample offer sent immediately to all who send name at once. Hurry, postal will do. SEND NO MONEY—just your name. KRISTEE CO., Dept. 675, Akron 8, Ohio

MAKE EXTRA MONEY

PLASTICS

LEARN AT HOME

LEARN HOW TO MAKE fast-selling PLASTIC NOVELTIES FURNITURE JEWELRY

There are RICH OPPORTUNITIES for MEN and WOMEN with "know-how" in Plastics. Interstate's new Plastics course tells and shows how to make hundreds of fast selling items out of Plastics. Gives complete training in fabrication, casting, lamination, molding, internal carving, etc., in simple, easy, step-by-step language and pictures. Plastics and Fabricating Kits for 23 valuable Plastic items come with training at no extra cost. START A PLASTICS BUSINESS OF YOUR OWN. No other industry holds such promise for the future. You can make big money manufacturing novelties, toys, signs, etc., in your own home in spare or full time. Don't wait! Learn NOW how Interstate's Plastics Training qualifies you for success in the Plastics field.



WRITE TODAY!

PLASTICS AND SUPPLIES FURNISHED FOR 23 VALUABLE PROJECTS

INTERSTATE TRAINING SERVICE

Dept. C-3-C

Portland 13, Oregon

POPULAR MECHANICS

Copyrighted material

THESE MEN ARE GETTING PRACTICAL TRAINING IN **ELECTRICITY**

—**ELECTRONICS**

On Real:



**A.C. and D.C. MOTORS
GENERATORS
SWITCHBOARDS
CONTROLLERS
WIRING JOBS
APPLIANCES
ELECTRONIC UNITS**

(Shown at left—Instructor explaining operation and testing of a large Motor Generator in our A.C. Department.)

AND **TELEVISION-RADIO**

On Real:

**TELEVISION SETS
RADIO RECEIVERS
F.M.
(Frequency Modulation)
ELECTRONICS
RECORD CHANGERS
AUTO RADIOS
PUBLIC ADDRESS Systems**

(Right—Instructor helping students check the wiring and trace circuits of television receivers.)



Train in the great **SHOPS** of **COYNE**

Largest, Oldest, Best Equipped School Of Its Kind In The U. S.

Whether 17 or up to 45 years of age, prepare for your future now. Don't be satisfied with a "No Future" job. Train the Coyne way for a better job in a field that offers a world of opportunities in the years ahead.

FINANCE PLAN Enroll now, pay most of tuition later. Part-time employment service while training, if needed.

WE TRAIN YOU IN CHICAGO. At Coyne you learn on real, full-size equipment. Trained instructors show you how, then you do practical jobs yourself. No previous experience or advanced education needed.

CLIP COUPON NOW for big new illustrated Coyne book "Guide to Careers in ELECTRICITY and TELEVISION-RADIO". No obligation; no salesman will call. Get vital facts now!



*Mail Coupon for
Big Free Book*

**APPROVED
FOR
VETERANS**

**B. W. COOKE, President
COYNE ELECTRICAL SCHOOL
500 S. Paulina St., Chicago 12, Ill. Dept. 34-72H**

Send **BIG FREE** book and details of your training offer. This does not obligate me and no salesman will call. I am interested in:

ELECTRICITY **TELEVISION-RADIO**

NAME

ADDRESS

CITY.....STATE.....

B. W. COOKE, Pres. COYNE ELECTRICAL SCHOOL FOUNDED 1899
A TECHNICAL TRADE INSTITUTE CHARTERED NOT FOR PROFIT
500 S. PAULINA St., CHICAGO, Dept. 34-72H
ELECTRICITY ★ RADIO ★ TELEVISION ★ REFRIGERATION ★ ELECTRONICS

AUDELS Carpenters and Builders Guides 4 vols. \$6



Inside Trade Information for Carpenters, Builders, Joiners, Building Mechanics and all Woodworkers. These Guides give you the short-cut instructions that you want—including new methods, ideas, solutions, plans, systems and money saving suggestions. An easy progressive course for the apprentice and student. A practical daily helper and Quick Reference for the master worker. Carpenters everywhere are using these Guides as a *Helping Hand to Easier Work, Better Work and Better Pay.* To get this assistance for yourself, simply fill in the **FREE COUPON** below.

Inside Trade Information On:

How to use the steel square—How to file and set saws—How to build furniture—How to use a mitre box—How to use the chalk line—How to use rules and scales—How to make joints—Carpenters arithmetic—Solving mensuration problems—Estimating strength of timbers—How to set girders and sills—How to frame houses and roofs—How to estimate costs—How to build houses, barns, garages, bungalows, etc.—How to read and draw plans—Drawing up specifications—How to excavate—How to use settings 12, 13 and 17 on the steel square—How to build hoists and scaffolds—skylights—How to build stairs—How to put on interior trim—How to hang doors—How to lath—lay floors—How to paint.

Step up your own skill with the facts and figures of your trade. Audels Mechanics Guides contain Practical Inside Trade Information in a handy form, Fully illustrated and Easy to Understand. Highly Endorsed. Check the book you want for **7 DAYS FREE EXAMINATION.** Send No Money, Nothing to pay Postman.



MAIL ORDER



Check NOW!

You Can Look Over Any Guide In Your Own Home — Start the Easy Payments If Satisfied

MAIL THIS TODAY



AUDEL Publishers, 49 W. 23 St., NEW YORK 10, N. Y.
Please send me postpaid for **FREE EXAMINATION** books marked (x) below. If I decide to keep them I agree to mail \$1 in 7 Days on each book or set ordered and further mail \$1 monthly on each book or set until I have paid price, otherwise I will return them.

- AUTOMOBILE MECHANICS GUIDE, 1800 Pages \$4
- TRUCK & TRACTOR GUIDE, 1299 Pages . . . 4
- DIESEL ENGINE MANUAL, 575 Pages . . . 2
- MACHINISTS HANDY BOOK, 1650 Pages . . . 4
- WELDERS GUIDE, 400 Pages . . . 1
- BLUE PRINT READING, 416 Pages . . . 2
- MATHEMATICS & CALCULATIONS, 700 Pages . . . 2
- SHEET METAL PATTERN LAYOUTS, 1100 Pages . . . 4
- SHEET METAL WORKERS HANDY BOOK, 388 Pgs. 1
- MECHANICAL DRAWING GUIDE, 160 Pages . . . 1
- MECHANICAL DRAWING & DESIGN, 480 Pages . . . 2
- AIRCRAFT WORKER, 240 Pages . . . 1
- TELEVISION SERVICE MANUAL, 384 Pages . . . 2
- RADIODIAGNOSIS GUIDE, 914 Pages . . . 4
- ELECTRONIC DEVICES, 216 Pages . . . 2
- ELECTRIC MOTOR GUIDE, 1000 Pages . . . 4
- ELECTRIC WIRING DIAGRAMS, 272 Pages . . . 1
- ELECTRICIANS EXAMINATIONS, 250 Pages . . . 1
- ELECTRIC POWER CALCULATIONS, 425 Pages . . . 2
- HANDY BOOK OF ELECTRICITY, 1440 Pages . . . 4
- ELECTRIC DICTIONARY, 9000 Terms . . . 2
- ELECTRIC LIBRARY, 7000 Pages (12 Book Set) 18
- MARINE ENGINEERS HANDY BOOK, 1258 Pgs. 4
- SHIPFITTERS HANDY BOOK, 250 Pages . . . 1
- REFRIGERATION & Air Conditioning, 1280 Pgs. 4
- MILLWRIGHTS & MECHANICS GUIDE, 1200 Pgs. 4
- POWER PLANT ENGINEERS GUIDE, 1500 Pages 4
- ENGINEERS & FIREMANS EXAMS, 525 Pages . . . 1
- PUMPS, Hydraulics & Air Compressors, 1658 Pgs. 4
- ENGINEERS LIBRARY (3 Book Set) . . . 9
- MECHANICAL DICTIONARY, 950 Pages . . . 4
- GARDENERS & GROWERS GUIDES (4 Book Set) 6
- CARPENTERS & BUILDERS GUIDES (4 Book Set) 6
- PLUMBERS & Steamfitters Guides (4 Book Set) 6
- MASONS AND BUILDERS GUIDES (4 Book Set) 6
- PAINTERS & DECORATORS MANUAL, 450 Pgs. 2
- HOUSE HEATING GUIDE, 1000 Pages . . . 4
- OIL BURNER GUIDE, 384 Pages . . . 1

Name _____
Address _____
Occupation _____
Employed by _____

"How to Become a Mail Order Millionaire"



SENT FREE!

RUSH NAME ON POSTCARD TODAY

Read the inside facts about hundreds of "little fellows" who are running Mail Order businesses from their homes—many making \$20,000 and more every year! Learn how small investments (\$16.80 in one case!) have mushroomed into profits of thousands. This incredible reprint from *Mechanics Illustrated* will be sent absolutely free, along with details showing how you can quickly master the secrets of getting orders and money in your daily mail, in a business that's all yours. Rush name today. A postcard will do.

The L. W. SURVEY 805 Larrabee St., Dept. 13, Los Angeles 46, California

HOMECRAFTERS

Member of HOME INDUSTRIES Association Inc.

Make Money at Home

Join non-profit national organization which promotes home-craft products and services. Group benefits at cost—How-to-DO-IT PUBLICATIONS • MONEY-MAKING IDEAS • MARKET RESEARCH • ADVERTISING & MAIL ORDER SERVICES • SALES REPRESENTATION • GROUP INSURANCE • ACCOUNTING & TAX SERVICES. Send \$3.00 today for year's membership, descriptive booklet and credentials.

HOME INDUSTRIES ASSOCIATION Inc.
1727 K STREET N. W. WASHINGTON 6, D. C.

\$750 BUILDS 4 ROOMS & BATH!

WHY PAY RENT?

For Seven Hundred Fifty Dollars and 30 days of your spare time, you can build yourself this Beautiful Home. Living Room 11x15, Front bedroom 9x11, Back bedroom 10x12, Kitchen 9x11, Bath 5x8, Hall 3x4. Wind out steel casement windows, Concrete block, stuccoed, Step-by-step illustrated instructions, blueprint and material list \$1.00 incl. No COD. Moneyback guaranteed. Economy Home, Dept. C Box 645 Columbus 16, Ohio



Become a SUPERMAN MENTAL

OVERNIGHT! Floor everybody! Revolutionary "MEMO-PROP" does all your thinking! It's amazing! Unprecedented! FREE LITERATURE! 8110U STUDIO, BOX 1727MH, HOLLYWOOD 28, CAL.

BECOME AN EXPERT IN TRAFFIC

Traffic men earn \$4,000 to \$10,000 and up. Thousands of firms need experts on rates, tariffs, regulations. We train you thoroughly in spare time at home for executive traffic jobs. Personal training under traffic authorities. Placement counsel and help. Write for free 48-page book "Traffic Management—the Fast Growing Profession."

LASALLE Extension University, 417 So. Dearborn St., A Correspondence Institution Dept. 364T Chicago 5, Ill.

FALSE TEETH KLUTCH holds them tighter

KLUTCH forms a comfort cushion; holds dental plates so much firmer and snugger that one can eat and talk with greater comfort and security; in many cases almost as well as with natural teeth. Klutch lessens the constant fear of a drooping, rocking, chafing plate. 35c and 60c at druggists . . . If your druggist hasn't it, don't waste money on substitutes, but send us 10c and we will mail you a generous trial box.

KLUTCH CO. Box 5493C ELMIRA, N. Y.

POPULAR MECHANICS

START YOUR FUTURE TODAY!

Get the facts on NATIONAL SCHOOLS' famous Shop-Method Home Training!



RADIO-TELEVISION & ELECTRONICS

A BRIGHT FUTURE awaits you in booming Radio-TV industry. More than 100 million radio sets, 20 million TV sets, now in use! Backed by National Schools' famous Shop-Method Training from America's Radio-TV Capital you can command good wages in the opportunity-career of your choice — engineer, service-repair, inspector, designer — in radar, electronics — or your own profitable business! Make that bright future come true... start now! **WE GIVE YOU COMPLETE PARTS, INCLUDING HIGH-MU TUBES!**

Yours to keep. You learn by doing, actually build generators, R-F oscillators, and this big Super-Het receiver! **WE GIVE YOU THIS STANDARD PROFESSIONAL MULTITESTER!** Locates trouble, adjusts delicate circuits—a valuable profit-earner



for you when you become a qualified Radio-TV technician!



FREE! RADIO-TV BOOK & LESSON!



FREE! AUTO-DIESEL BOOK & LESSON!

MAIL COUPON NOW START YOUR HIGH-PAYING FUTURE TODAY!



AUTOMOTIVE-DIESEL & ALLIED MECHANICS

LEARN HOW YOU TOO CAN EARN TOP MONEY IN THESE BOOMING INDUSTRIES!

EXPANDING AUTO-DIESEL INDUSTRY needs more and more trained men! 55 million vehicles now operating, 6 million more this year—plus 150,000 new Diesel units! Garages, car dealers, transit lines, defense plants, manufacturers, are desperate for

the kind of *trained specialists* produced by National Schools' "Shop-Method Home Training." Start now on the road to lifetime security. Mail the coupon today!

WE GIVE YOU THE TOOLS OF YOUR TRADE! This fully-equipped, all-metal Tool Kit is yours to keep. We also give you a complete set of precision drawing instruments, and Slide Rule. These professional tools help you learn, then earn!



NATIONAL SCHOOLS

Technical Trade Training Since 1905

LOS ANGELES 37, CALIFORNIA

In Canada: 811 West Hastings Street Vancouver, B.C.

Both Home Study and Resident Courses Offered



LET NATIONAL SCHOOLS of Los Angeles, California, a Resident Technical Trade School for nearly half a century, train you at home for a high-paying future in these big-future industries.

Earn While You Learn!

Make extra money repairing friends' and neighbors' cars, trucks, radios, TV sets, appliances. Every step fully explained and illustrated in National Schools' famous "Shop-Tested" lessons. Latest equipment and techniques covered. You master all phases—start part-time earnings after a few weeks!

YOU RECEIVE FRIENDLY GUIDANCE, both as a student and graduate. Our special Welfare Department is always at your service, to help you with technical and personal problems. You receive full benefit of our wide industry contacts and experience.

DRAFT AGE? National Schools training helps you get the service branch, and higher pay grade you want.



APPROVED FOR G. I. TRAINING

GET FACTS FASTEST! MAIL TO OFFICE NEAREST YOU!

(mail in envelope or paste on postal card)

NATIONAL SCHOOLS, Dept. B-34

4000 S. Figueroa Street Los Angeles 37, Calif. or 323 West Polk Street Chicago 7, Ill.

Please rush Free Book & Sample Lesson checked below. No obligation, no salesman will call.

- "My Future in Radio-Television & Electronics"
 "My Future in Automotive-Diesel & Allied Mechanics"

NAME _____ BIRTHDAY _____ 19__

ADDRESS _____

CITY _____ ZONE _____ STATE _____

Check here if interested in Resident School Training at Los Angeles. VETERANS: Give Date of Discharge _____

Inventors

The following are the usual preliminary steps to take toward patent protection.

You are advised first, to make a disclosure of your invention. Date, sign and have this document witnessed by two or more persons who are capable of understanding your invention. The "Evidence of Invention" form mentioned below, we offer as a convenience in making your disclosure and in starting action leading toward patent protection.

Mail your disclosure to the registered patent attorney or agent whom you select to assist you, together with a letter authorizing him to conduct a

preliminary search among previously granted U. S. patents for similar types of invention. He then prepares for you a report on the probable patentability of your invention and, if the report is favorable, recommends the further course you should take.

This firm is registered to practice before the U. S. Patent Office and is available to assist you in the preparation and prosecution of patent applications. We shall be glad to send you without obligation, the "Evidence of Invention" disclosure form mentioned above and our instructive booklet, "Patent Protection for Inventors".

VICTOR J. EVANS & Co. *Merlin M. Evans*
REGISTERED PATENT ATTORNEY
930-C MERLIN BUILDING, WASHINGTON 6, D. C.



Grow with Diesel

and SCIENTIFIC MOTOR TUNE-UP
—One of America's Fastest-Growing Big-Pay Industries!

Get ready now . . . Make a place for yourself in the mighty Diesel industry. Be there to take advantage of the opportunities ahead. The U.E.I. Plan for learning Diesel is simple, practical and is based upon the principle of learning-to-do-by-doing. Includes Auto Engine Tune-Up. You get fundamentals through spare-time home-study, followed by actual shop practice on modern Diesel engines. Experienced instructors guide you step-by-step — you learn the HOW and WHY of Diesel operation, service and maintenance. Get all the facts—mail the coupon and we'll send you a free copy of "Earning Power in Diesel." Mail coupon today!



UTILITIES ENGINEERING INSTITUTE
Dept. DC-37, (Founded 1927) Chicago 14, Ill.

UTILITIES ENGINEERING INSTITUTE, Dept. DC-37
2921 Sheffield Ave., Chicago 14, Illinois

Please send me, without obligation, your free book, "Earning Power in Diesel."

NAME (print).....AGE.....

ADDRESS

CITY..... Zone..... State.....

Check here for information if you are under 17

A "GOOD HAND" HELPS YOU SUCCEED!
LEARN TO WRITE WELL

Your Name

Handwriting quickly improves with our easy-to-understand picture lessons! Put your spare time to good use; send today for FREE BOOKLET, "How to Become a Good Penman," or check volumes wanted below at \$1 each: Business Writing Artistic Writing Card Writing Bird & Design Flourishing Engraving Alphabets. COMPLETE SET \$4.50. Ask for price list of penman's supplies.

OUR 53rd YEAR

TAMBLYN SCHOOL of PENMANSHIP
S.A. Ziller, Pres., 442 Ridge Bldg., Kansas City, Mo., USA

Beautifully written, plus special pen-point for shaded writing. Only 10¢

Secrets of VENTRILOQUISM Now Revealed!

Easy to learn in 60 to 90 days with our Home Study Course. RESULTS GUARANTEED. Make Money! Be Popular! Have Fun! Big Opportunity! Radio, Television, Stage Appearances! For FREE information regarding price and terms, WRITE. You must state your age. Dummy Catalog 25c.

FRED MAHER SCHOOL OF VENTRILOQUISM
Box 36, Studio C Kensington Station
Detroit 24, Michigan

FALSE TEETH

**That Loosen
Need Not Embarrass**

Many wearers of false teeth have suffered real embarrassment because their plate dropped, slipped or wobbled at just the wrong time. Do not live in fear of this happening to you. Just sprinkle a little **FAS-TEETH**, the alkaline (non-acid) powder, on your plates. Holds false teeth more firmly, so they feel more comfortable. Does not sour. Checks "plate-odor" (denture breath). Get **FASTEETH** at any drug counter. **FREE!** Write for generous sample to 55 Wall St., Binghamton, N. Y.

POPULAR MECHANICS

Now **IN YOUR OWN HOME** Learn

TELEVISION

RADIO-ELECTRONICS

the Amazingly Effective

D. T. I. WAY

—with the aid of BOTH HOME EQUIPMENT and HOME MOVIES

NO PREVIOUS EXPERIENCE NEEDED

NOW... get **EVERYTHING YOU NEED**

for real Laboratory-type training **AT HOME**

Above: Work over 300 fascinating experiments with this equipment

1. Build over 300 fascinating experiments from 16 BIG SHIPMENTS of Electronic-Radio parts which you KEEP.

2. Build valuable commercial-type test equipment—as shown to the left—which you KEEP. This includes a quality 5 INCH oscilloscope and jewel bearing Multi-Meter—both highly useful for Television work.

3. Build and keep a big 21 INCH TV Set. (D.T.I. offers another home training in Television-Radio-Electronics, but without the TV set.)

4. Use a 16 mm. movie projector and new series of highly instructive movies—a wonderful aid to help you grasp important fundamentals faster... easier... better.

5. Enjoy well-illustrated, easy-to-read lessons with handy FOLD-OUT diagrams.

6. Get an honest-to-goodness EMPLOYMENT SERVICE to help you get a good job after graduating—or assistance in starting your OWN SALES AND SERVICE BUSINESS. Mail coupon today for the complete details.

Get this information-packed publication

Get this

FREE!

Mail Coupon Today

DEVRY TECHNICAL INSTITUTE Dept. PM-3-K
4141 BELMONT AVE., CHICAGO 41, ILL.

I would like your valuable information-packed publication showing how I can get started toward a good job or my own business in Television-Radio-Electronics.

Name.....Age.....

Street.....Apt.....

City.....Zone.....State.....



5 INCH "SCOPE"

Oscilloscope

Multi-Meter



21 INCH

Build and keep this BIG DTI Engineered TV set—easily converted to U.H.F. (DTI offers another home training, but without the TV set.)



"ONE OF AMERICA'S FOREMOST TELEVISION TRAINING CENTERS"



89 WAYS TO EARN MONEY IN TELEVISION RADIO-ELECTRONICS

DEVRY TECHNICAL INSTITUTE
AFFILIATED WITH
DEFOREST'S TRAINING, INC.
CHICAGO 41, ILLINOIS



**YOU
can
acquire**

**LAW NIGHTS AT HOME!
L. L. B. DEGREE**

LaSalle's famous Law Library—used as reference in many Law libraries and Law offices—has enabled thousands to master Law surprisingly fast, in spare hours at home, for business and professional advancement.

These 14 remarkable volumes, compiled by leading professors and lawyers, cover the whole basic field of Law in condensed, orderly, simplified manner.

You advance rapidly with this great library, plus special lectures furnished. We guide you step-by-step with personalized Problem Method of instruction... you learn by doing—handling legal problems—not by memorizing rules.

Send for two FREE 48-page booklets, "Law Training for Leadership," and "Evidence," answering questions about Law and its value to you, and telling how LaSalle Law graduates are winning rapid advancement in business and public life. Mail coupon below. No obligation.

**LA SALLE EXTENSION UNIVERSITY
A Correspondence Institution**

417 S. Dearborn St. Dept. 364L Chicago 5, Ill.

Send me your two FREE booklets described above, without obligation.

Name.....Age.....

Street.....

City, Zone & State.....

**ENGINEERING DEGREE IN
27 MONTHS**

Big Demand for Graduates

Aeronautical, Chemical, Civil, Electrical, Mechanical and Radio Engineering (inc. TV and Electronics)

Hundreds of young men are earning B. S. ENGINEERING DEGREES annually in this recognized institution — year around operation. New terms start quarterly. Many students earn a major part of their college expenses in this large industrial center.

Low tuition. Competent instruction. Thorough, intense, practical program. Modern, well-equipped laboratories including new physics laboratory and modern wind tunnel. Individualized instruction emphasized.

Government approved for G.I.'s. Engineering preparatory courses. Students from 48 states and 21 foreign countries. Enter March, June, September, December. Send coupon for free catalog and full information. Enroll now.

SEND COUPON TODAY

INDIANA TECHNICAL COLLEGE

534 E. Washington Boulevard
Fort Wayne 2, Indiana

Please send me free information on B.S. Engineering Degree in 27 months as checked.

- Aeronautical, Chemical, Civil, Electrical,
 Mechanical, Radio-Television

Name.....

Address.....

For FUN and PROFIT

**MOUNT
Animals &
Birds**

Tan SKINS, make up FURS

Learn TAXIDERMY, at home, by mail. Be a TAXIDERMIST. This old reliable school can teach you, easily and quickly. We have more than 300,000 delighted students, all hunters, trappers and nature-lovers. Get the wonderful FREE BOOK TODAY, and learn to mount BIRDS, ANIMALS, GAME-HEADS and FISH.

SPORTSMEN—MEN, BOYS Here is the world's greatest art and hobby for hunters, anglers, nature-lovers. Taxidermy is surely your art. It has swept the world among SPORTSMEN. Investigate now. You will be delighted.

FREE BOOK YES, free to you now. Marvelous, valuable, strange; tells all about how to learn taxidermy at home. 48 pages, 100 beautiful photos of wild game. Send for your copy TODAY. Here is your great opportunity. Send NOW. A postal will do. Please state your AGE.

N. W. School of Taxidermy, 2503 Elwood Bldg., Omaha 8, Neb.

'How to Make Money with Simple Cartoons'

A book everyone who likes to draw should have. It is free; no obligation. Simply address **FREE BOOK**

CARTOONISTS' EXCHANGE
Dept. 93D Pleasant Hill, Ohio

Learn MECHANICAL DENTISTRY

A profession offering unlimited opportunities. Most modern and complete course embracing every branch from Plate to Porcelain Work, which prepares you to work for Dentists or start your own business. Individual instruction—practical training in day or night school. No books—no classes. Catalog upon request.

MCCARRIE SCHOOL OF MECHANICAL DENTISTRY
207 N. Broad Street Dept. 27 Philadelphia 7, Penna.

COMPLETE KIT For Handbag Repairmen, Hobbycrafters

Whether it's your business or your hobby, the Monal Kit's amazing assortment of handbag locks, turn locks, hook locks, lift locks, snap locks, strap handle holders and clips, has everything you need. \$4.95 prepaid. Send 10 cents (Refunded with Order) for graphic photo of every item in the KIT.

MONAL CO. 102 WESTWOOD AVE. CRANSTON 5, R. I.

Ball-Bearing SPEED WHEELS

JUVENILE WHEELS (No bearing, solid tires)

5"45c	5"65c
7"			
(Semi-pneumatic tire, ball bearing)			
8x1.25 ..	\$1.85	10x1.25 ..	\$2.20
8x1.75 ..	1.95	10x1.75 ..	2.30
8x2	2.20	10x2.00 ..	2.65
12x1.75			
12x1.75			
16x4.00			
INDUSTRIAL WHEELS			
Lug Base, Semi-Pneumatic tire			
6x2 SW ..	\$3.45	10x2.00 ..	\$6.10
6x2.00 ..	4.00	10x2.75 ..	5.15
8x2.00 ..	5.20	12x2.00 ..	6.90
8x2.50 ..	5.40	12x3.00 ..	9.20
16x4.00			
Smooth Base, Pneumatic tire and tube			
8x3.00 ..	\$11.00	12x4.00 ..	\$12.10
10x2.75 ..	6.80	4.00x8 ..	13.10
10x3.50 ..	10.55	14x4.50 ..	13.40

Available Now — CASTERS
Write for circulars on all wheels.
No c.o.d. orders. Prices F.O.B. our plant.

JIM BROWN TOY COMPANY
1095 HOME AVENUE PM-354 AKRON 10, OHIO



Cut-away diagrams make every operation easy. Above — Ford clutch.



Diagrams, tables and text take the "mystery" out of all ignition systems.



You get illustrated repair procedures for all types of carburetors.

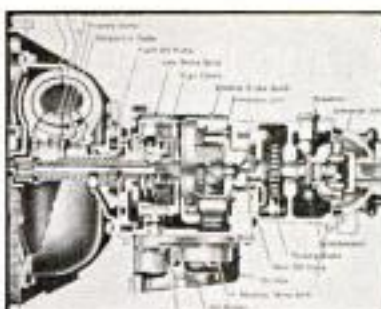

Buick Dynaflo. Book crammed with 2500 diagrams, photos, cutaway pictures (of which these are mere miniatures) that show every part in detail. ALL automatic transmissions are fully covered.

Here's the EASY Step-by-Step Way to FIX ANY CAR IN A JIFFY!



Fuel pumps can cause trouble. Pictures show exactly how to take them apart, fix them.



No guesswork. Clear pictures show how to fix water pump, generator, brakes, chokes, etc.

Just 2 of the Many Letters of Praise Does Every Job. "My MOTOR Manual is a wonderful help. It has put me in a position to do every job." — S. L. Sharpless, Los Angeles, Calif.
Amazed Self and Friends. "I amazed myself and my friends, too. Now do jobs that stumped me before." — Michael Bolicsky, Newark, N. J.

Now—Whether You're a Beginner or Expert Mechanic—You Can "Lick" Any Repair Job On Any Car Built from 1935 thru 1953

NOW you can tackle any repair job, and do it quickly, easily, right—the first time! **MOTOR'S BRAND-NEW AUTO REPAIR MANUAL** shows you how—with crystal-clear pictures and step-by-step directions you can easily follow.

No guesswork. This giant guide tells you where to start; what tools to use. Leads you easily and quickly through the entire operation. Covers everything from a simple carburetor adjustment to a complete overhaul.

Everything You Need to Know

BIG, NEW REVISED Edition has MORE REPAIR INFORMATION THAN EVER! Over 850 giant pages, 2,500 "This-Is-How" pictures — clear drawings, diagrams, cut-away photos — make every step EASY. Over 200 "Quick Check" charts — more than 37,000 essential repair specifications. Over 227,000 service and repair facts. Instructions and pictures so COMPLETE, so CLEAR — you CAN'T go wrong!

Even a green beginner can do a good job. If you're a top mechanic, you'll be amazed at the time-saving procedures.

The "Meat" of Over 189 Official Shop Manuals

The editors have put together the "Know-How" from over 189 Official Shop Manuals; "boiled it down" into one handy indexed book.

Includes ALL Automatic Transmissions (including Dual Range Hydra-Matic). Covers the newest Carburetors, Engines (including new Buick & Dodge V-8s) ... Chokes ... Fuel Pumps ... Oil Filters ... Starting Motors ... Generators ... Distributors ... Clutches ...

Universals ... Axles ... Brakes ... Power Steering ... Shock Absorbers, etc.

Factory Specifications and Adjustment Tables, Tune-up Charts, Tables of Measurements and Clearances, Overhauling and Replacement Facts—AND MUCH MORE.

Used by Armed Forces, hundreds of thousands of auto service men! YOU'LL want to try it, too—on the following UNCONDITIONAL GUARANTEE:

Try Book for a Week FREE

SEND NO MONEY. Pay nothing to postman. Test book in your own garage or shop. It's GUARANTEED to pay for itself in 7 days. If it doesn't just return the book, and owe nothing. Rush coupon for your free-trial copy of this great money-saving Manual. **MOTOR BOOK Dept., Desk 1CX, 250 West 55th St., New York 19, N. Y.**

USED BY
**U.S. ARMY
NAVY
MARINES**



MAIL COUPON NOW FOR 7-DAY FREE TRIAL

MOTOR Book Dept., Desk 1CX, 250 West 55th Street, New York 19, N. Y.
Rush to me at once: (Check box opposite book you want).
 MOTOR'S New AUTO REPAIR MANUAL. If okay, I'll remit just \$1.00 in seven days, then \$2.00 monthly for two months and a final payment of 03c (plus 35c delivery charge) one month after that. Otherwise, I'll return the book postpaid in seven days. (Foreign price: Remit \$8.00 cash with order.)
 MOTOR'S New TRUCK and TRACTOR REPAIR MANUAL. (Described at left.) If okay I will remit \$2.00 in seven days, and \$2.00 monthly for three months, plus 35c delivery charge with final payment. Otherwise, I will return book promptly. (Foreign price: Remit \$10.00 cash with order.)
Print Name.....Age.....
Print Address.....
City & Zone No.....State.....
 SAVE 35c delivery charge by enclosing WITH COUPON check or money order for full payment of \$3.95 for Auto Repair Manual (or \$8.00 for Truck and Tractor Manual). Same 7-day return-for-refund privilege applies.

COVERS 872 MODELS— ALL THESE MAKES

- | | | |
|-----------|-----------|------------|
| Buick | Henry J | Nash |
| Cadillac | Hudson | Rambler |
| Chevrolet | Kaiser | Oldsmobile |
| Chrysler | Lafayette | Packard |
| Cresley | La Salle | Plymouth |
| De Soto | Lincoln | Pontiac |
| Dodge | Mercury | Studebaker |
| Ford | Nash | Terraplane |
| Fraser | | Willys |

Some FREE 7-Day Offer on MOTOR'S TRUCK and TRACTOR REPAIR MANUAL
Covers EVERY job on EVERY gasoline-powered truck and farm tractor made from 1930 thru 1953. 2200 pictures, 904 big 8 1/2 x 11 inch pages, 300,000 facts. Check proper box in coupon for free trial.

AMERICAN TECHNICAL SOCIETY (Founded 1898)

Offers You the Opportunity to
Prepare for Higher Earnings
in Building and Contracting



THESE 9
HOW-TO-DO-IT
VOLUMES
ON APPROVAL

SEND
NO MONEY
•
MORE THAN
4000 PAGES
•
2750
PICTURES

Examine this Up-to-Date Edition for 10 days. See how these nine books supply easily understood self-training that will help you get a better job and make more money, or start a profitable business for yourself. Have these books handy for use in solving all sorts of building problems.

PAY-RAISING INFORMATION

Learn to draw plans, estimate, do all-new construction and modern remodeling to meet fast-growing demand. More than 4000 pages of practical, pay-raising information with 2750 helpful illustrations, on such subjects as blueprint reading, concrete forms, masonry, carpentry, steel square, electrical wiring, plumbing, heating, painting and hundreds more.

In our more than 50 years we have never offered more complete building information. SEND THE COUPON TODAY.

(A year's consulting privileges with our staff given with these books without extra cost.)

AMERICAN TECHNICAL SOCIETY—Publishers Since 1898
Dept. G319, Drexel Ave. at 58th St., Chicago 37, Ill.

I would like to examine your 9-Volume Set of Building, Estimating, Contracting Books. I will pay the delivery charges only, but if I choose I may return them express collect. If after 10 days' use I prefer to keep them, I will send you \$1 plus postage and pay the balance at the rate of only 84 a month until \$34.80 has been paid.

Name _____

Address _____

City _____ State _____

Please attach letter giving employer's name and address (if self-employed give business man's name as reference. Men in service please give home address.)



**Earn BIG STEADY MONEY
SELL WORK UNIFORMS!**

It's easy with TOPPS great "Panoramic" line that spreads out over 8 feet wide! Swatches are king size! Style figures are big, full color—they almost pop off the page! Prospects are everywhere—garages, service stations, factories, etc. Profits are big—one man made \$800 on a single sale! Selection of sizes, fabrics (including DuPont's miracle ORLON), colors, accessories is unlimited. Start spare time... you'll make it a career! Get the "Panoramic" line FREE. Write TODAY.
TOPPS Dept. 613 - Rochester, Indiana

IT PAYS to know—
WATCHMAKING

Turn dull spare hours to pleasure and profit. Watchmaking is light, clean, fascinating. Ideal for handicapped. Learn modern methods, step by step, at home or Chicago school. No previous experience needed. Approved for veterans. Send for FREE sample lesson. No obligation.

CHICAGO SCHOOL OF WATCHMAKING

2330 Milwaukee Ave., Dept. 134, Chicago 47, Ill. Veteran
Send me FREE sample lesson Home study Resident school

Name _____

Address _____

City _____ Zone _____ State _____

100 YEAR OLD U.S. STAMPS



We will send "On Approval" all United States stamps, even those over 100 years old. We will also send "On Approval" all foreign stamps in singles and sets, including such famous issues as Coronations, Roosevelts, etc. Ours is the only stamp house able to render such service. Just send 10c for our introductory bargain of 50 different U.S. stamps and fascinating stamp literature.

GLOBUS STAMP CO.

268 — 4th Ave. New York 10, N.Y. Dept. 213

MEN AND WOMEN TRAINED AT HOME
FOR PROSPEROUS BUSINESS IN

UPHOLSTERING

Tools, Supplies, everything necessary to get started sent. Illustrated training shows how — progress rapidly. No previous experience necessary. Make over old furniture, sell for many times cost to you. Establish full or part time money making business. Free booklet explains plan. Send name, address to

COMMERCIAL TRADES INSTITUTE

1400 GREENLEAF, DEPT. U2-3, CHICAGO 26, ILL.

IMPROVE YOUR PENMANSHIP

Write Like This Complete OUTLINE FREE!
YOUR penmanship can be improved in 3 hours or corrected to your satisfaction in 10 hours' practice with my DEFINITE HAND CONTROLS. New way!
WRITE OZMENT BOX 665 34-N, ST. LOUIS, MISSOURI

FREE INFORMATION

Find URANIUM, GOLD, SILVER

and other valuable metals with the latest scientific instruments available. Guaranteed. Free Information. Write TODAY to:

THE DETECTOR CORP., Dept. PM-1
5420 N. Vineland, N. Hollywood, Calif.

CASTING SECRETS REVEALED

Big money! Cast 1000's of plaques, figurines, etc. with X.L. rubber molds. No exper., little capital req. X.L. rubber pte. \$2.50, qta. \$4 (postage extra). Models, Rubber for 3 molds, \$1.50 ppd. U. S. only. Send 25c (refundable) for 40 pp fact catalog.

HUGE PROFITS!
MORE MONEY!

PLASTIC ARTS STUDIO, Dept. 3,
3403 S. Madison St., Muncie, Ind.

RUPTURED?

Get Relief This Proven Way

Why try to worry along with trusses that gouge your flesh — press heavily on hips and spine — enlarge opening — fail to hold rupture? You need the Cluthe. No leg-straps or cutting belts. Automatic adjustable pad holds at real opening — follows every body movement with instant increased support in case of strain. Cannot slip whether at work or play. Light. Waterproof. Can be worn in bath. Send for amazing FREE book, "Advice To Ruptured" and details of liberal truthful 60-day trial offer. Also endorsements from grateful users in your neighborhood. Write:

CLUTHE SONS, Dept. 31, Bloomfield, New Jersey.

POPULAR MECHANICS



How to compete with college men for the best jobs



You can break through the education barrier that bars you from top-salary jobs. You can climb as fast and as far as any college man. Whether your field of interest is engineering, business management or industrial supervision, you can hurdle your education handicaps. How? Listen . . .

AVOID THIS COMMON ERROR Why do men spend four years at college? To get a good job when they get out. And many of them stop right there. They get their good job and relax. A college education is a fine thing. But it's not a free ticket to automatic prosperity.

The non-college man with average intelligence and above-average ambition can beat the free-rider every time. All it takes is a little concentrated training.

TRAINING WHEN IT COUNTS You learn best when you can apply what you learn *on the spot*. I. C. S. training is closely related to your job. You master a problem one day and put it into practice the next.

No lectures to attend. No notes to take. Your professor is your specially edited text. Your laboratory is your shop or office.

What's more, by learning on-the-job, you are bound to move up. Your study is reflected in your work. Your employer gets regular reports of your progress. You demonstrate your willingness and ability to make good. No free-rider, you. You earn every promotion and you're a better man for it.

FREE EXPERT GUIDANCE In this competitive world, you need help. No other training institution has had more experience guiding men and women to success than the International Correspondence Schools. None offers a wider selection of success-proved courses.

Mark and mail the coupon below. You will get the famous 36-page guidebook, "How to Succeed," plus the 1953-54 catalog on the subject that interests you. Here's free expert guidance! Here's the way to start cracking the education barrier!

I. C. S., Scranton 9, Penna.

INTERNATIONAL CORRESPONDENCE SCHOOLS



BOX 5615-L, SCRANTON 9, PENNA.

Without cost or obligation, send me "HOW to SUCCEED" and the booklet about the course BEFORE which I have marked X:

- | | | | | |
|---|---|--|---|--|
| <p>ART</p> <ul style="list-style-type: none"> <input type="checkbox"/> Commercial Art <input type="checkbox"/> Magazine Illustrating <input type="checkbox"/> Fashion Illustrating <input type="checkbox"/> Cartooning <input type="checkbox"/> Sketching and Painting <input type="checkbox"/> Show Card and Sign Lettering <p>AUTOMOTIVE</p> <ul style="list-style-type: none"> <input type="checkbox"/> Automobile Mechanic <input type="checkbox"/> Auto Elec. Technician <input type="checkbox"/> Auto Body Rebuilding and Refinishing <input type="checkbox"/> Diesel—Gas Engines <p>AVIATION</p> <ul style="list-style-type: none"> <input type="checkbox"/> Aeronautical Engineering Jr. <input type="checkbox"/> Aircraft Engine Mechanic <input type="checkbox"/> Airplane Drafting <p>BUILDING</p> <ul style="list-style-type: none"> <input type="checkbox"/> Architecture <input type="checkbox"/> Arch. Drafting <input type="checkbox"/> Building Contractor <input type="checkbox"/> Estimating <input type="checkbox"/> Carpenter and Mill Work <input type="checkbox"/> Carpenter Foreman <input type="checkbox"/> Reading Blueprints <input type="checkbox"/> House Planning <input type="checkbox"/> Plumbing | <ul style="list-style-type: none"> <input type="checkbox"/> Heating <input type="checkbox"/> Painting Contractor <input type="checkbox"/> Air Conditioning <input type="checkbox"/> Electrician <p>BUSINESS</p> <ul style="list-style-type: none"> <input type="checkbox"/> Business Administration <input type="checkbox"/> Certified Public Accountant <input type="checkbox"/> Bookkeeping and Accounting <input type="checkbox"/> Office Management <input type="checkbox"/> Stenography and Typing <input type="checkbox"/> Secretarial <input type="checkbox"/> Federal Tax <input type="checkbox"/> Business Correspondence <input type="checkbox"/> Letter-writing Improvement <input type="checkbox"/> Personnel and Labor Relations <input type="checkbox"/> Advertising <input type="checkbox"/> Retail Business Management <input type="checkbox"/> Managing Small Business <input type="checkbox"/> Ocean Navigation <input type="checkbox"/> Sales Management <input type="checkbox"/> Short Story Writing <input type="checkbox"/> Creative Salesmanship <input type="checkbox"/> Traffic Management <p>CHEMISTRY</p> <ul style="list-style-type: none"> <input type="checkbox"/> Chemical Engineering <input type="checkbox"/> Chemistry <input type="checkbox"/> Analytical Chemistry | <ul style="list-style-type: none"> <input type="checkbox"/> Petroleum—Nat'l Gas <input type="checkbox"/> Pulp and Paper Making <input type="checkbox"/> Plastics <p>CIVIL, STRUCTURAL ENGINEERING</p> <ul style="list-style-type: none"> <input type="checkbox"/> Civil Engineering <input type="checkbox"/> Structural Engineering <input type="checkbox"/> Surveying and Mapping <input type="checkbox"/> Structural Drafting <input type="checkbox"/> Highway Engineering <input type="checkbox"/> Reading Blueprints <input type="checkbox"/> Construction Engineering <input type="checkbox"/> Sanitary Engineering <p>DRAFTING</p> <ul style="list-style-type: none"> <input type="checkbox"/> Aircraft Drafting <input type="checkbox"/> Architectural Drafting <input type="checkbox"/> Electrical Drafting <input type="checkbox"/> Mechanical Drafting <input type="checkbox"/> Structural Drafting <input type="checkbox"/> Sheet Metal Drafting <input type="checkbox"/> Ship Drafting <input type="checkbox"/> Mine Surveying and Drafting <p>ELECTRICAL</p> <ul style="list-style-type: none"> <input type="checkbox"/> Electrical Engineering <input type="checkbox"/> Electrician <input type="checkbox"/> Electrical Maintenance | <ul style="list-style-type: none"> <input type="checkbox"/> Electrical Drafting <input type="checkbox"/> Electric Power and Light <input type="checkbox"/> Lineman <p>HIGH SCHOOL</p> <ul style="list-style-type: none"> <input type="checkbox"/> High School Subjects <input type="checkbox"/> Mathematics <input type="checkbox"/> Commercial <input type="checkbox"/> Good English <p>MECHANICAL AND SHOP</p> <ul style="list-style-type: none"> <input type="checkbox"/> Mechanical Engineering <input type="checkbox"/> Industrial Engineering <input type="checkbox"/> Industrial Supervision <input type="checkbox"/> Foremanship <input type="checkbox"/> Mechanical Drafting <input type="checkbox"/> Machine Design—Drafting <input type="checkbox"/> Machine Shop Practice <input type="checkbox"/> Tool Design <input type="checkbox"/> Industrial Instrumentation <input type="checkbox"/> Machine Shop Inspection <input type="checkbox"/> Reading Blueprints <input type="checkbox"/> Toolmaking <input type="checkbox"/> Gas—Electric Welding <input type="checkbox"/> Heat Treatment—Metallurgy <input type="checkbox"/> Sheet Metal Work <input type="checkbox"/> Sheet Metal Pattern Drafting <input type="checkbox"/> Refrigeration | <p>POWER</p> <ul style="list-style-type: none"> <input type="checkbox"/> Combustion Engineering <input type="checkbox"/> Diesel—Electric <input type="checkbox"/> Electric Light and Power <input type="checkbox"/> Stationary Steam Engineering <input type="checkbox"/> Stationary Fireman <p>RADIO, TELEVISION COMMUNICATIONS</p> <ul style="list-style-type: none"> <input type="checkbox"/> Practical Radio—TV Eng'ring <input type="checkbox"/> Radio Operating <input type="checkbox"/> Radio and TV Servicing <input type="checkbox"/> Television—Technician <input type="checkbox"/> Electronics <input type="checkbox"/> Telephone Work <p>RAILROAD</p> <ul style="list-style-type: none"> <input type="checkbox"/> Locomotive Engineer <input type="checkbox"/> Diesel Locomotive <input type="checkbox"/> Air Brakes <input type="checkbox"/> Car Inspector <input type="checkbox"/> Railroad Administration <p>TEXTILE</p> <ul style="list-style-type: none"> <input type="checkbox"/> Textile Engineering <input type="checkbox"/> Cotton, Rayon, Woolen Mfg. <input type="checkbox"/> Carding and Spinning <input type="checkbox"/> Warping and Weaving <input type="checkbox"/> Loom Fixing <input type="checkbox"/> Throwing <input type="checkbox"/> Finishing and Dyeing <input type="checkbox"/> Textile Designing |
|---|---|--|---|--|

Name _____ Age _____ Home Address _____

City _____ Zone _____ State _____ Working Hours _____ A.M. to P.M. _____

Occupation _____

Canadian residents send coupon to International Correspondence Schools Canadian, Ltd., Montreal, Canada. . . . Special tuition rates to members of the U. S. Armed Forces.

NEW BODIES FOR OLD!



I've Made New Men Out of Thousands of Other Fellows...

"Here's what I did for THOMAS MANFRE... and what I can do for you!"

-Charles Atlas

GIVE me a skinny, second-rate body — and I'll cram it so full of handsome, bulging new muscle that your friends will grow bug-eyed! . . . I'll wake up that sleeping energy of yours and make it hum like a high-powered motor! Man, you'll feel and look different! You'll begin to LIVE!

Let Me Make YOU a NEW MAN — IN JUST 15 MINUTES A DAY

You wouldn't believe it, but I myself used to be a 97-lb. weakling. Fellows called me "Skinny." Girls made fun of me behind my back. THEN I discovered—"Dynamic Tension." And it turned me into such a complete specimen of MANHOOD that today I hold the title "THE WORLD'S MOST PERFECTLY DEVELOPED MAN."

My Secret — "Dynamic Tension"

When you look in the mirror and see a healthy, strapping fellow smiling back at you—then you'll realize how fast "Dynamic Tension" GETS RESULTS!

"Dynamic Tension" is the easy, NATURAL method you can practice in the privacy of your room—JUST 15 MINUTES EACH DAY — while your chest and shoulder muscles begin to swell, ripple . . . those arms and legs of yours bulge . . . and your whole body starts to feel full of zip and go! And you'll be using the method which many great athletes use for keeping in condition—prize fighters, wrestlers, baseball and football players, etc.

FREE My 32-page Book—Not \$1. or 10c — But FREE

Send NOW for my famous book, "Everlasting Health and Strength"—32 pages, crammed with photographs, valuable advice, answers to many vital questions.

This book is a real prize for any fellow who wants a better build. Yet I'll send you a copy absolutely FREE.

It may mean the turning point in your whole life! Rush the coupon to me personally: **CHARLES ATLAS, Dept. BC, 115 East 23rd St., New York 10, N.Y.**



**CHARLES ATLAS, Dept. BC
115 East 23rd St., New York 10, N. Y.**

Send me—absolutely FREE—a copy of your famous book, "Everlasting Health and Strength"—32 pages, crammed with actual photos, advice. I understand this book is mine to keep, and sending for it does not obligate me in any way.

Name _____ Age _____
(Please print or write plainly)

Address _____

City _____ State _____



PRESTO! ANYONE CAN MASTER GLAZE



Car Owners! Meet Master Glaze—the sensationally different luster for new and used cars! Not a wax—not an oil polish—not a paint!—nothing that "smears" over the surface.

MASTER GLAZE is a unique discovery—a creamy liquid—quick and easy to apply! Gives a hard, glass-like surface. Even gasoline cannot dull it! Lasts six months to a year! Amazing luster—beautiful, sparkling clean and brilliant! Doesn't finger-mark—doesn't smear! A match box full glazes an entire car. Seals the pores—protects! NOTHING LIKE IT!

FREE SAMPLE

Just send your name and address to

MASTER GLAZE CO., 7720-782 W. Harwood Ave., Milwaukee, Wis.

Learn ACCOUNTING Business Administration

Bookkeeping, secretarial and allied subjects at home in your spare time or attend nationally approved resident school. Write for FREE Success Book giving complete details on courses, plans, rates and employment opportunities. G.I. approved.



Hills BUSINESS UNIVERSITY AND EXTENSION SCHOOL

629 W. MAIN ST. OKLAHOMA CITY 2, OKLAHOMA



BOYS BUILD YOUR OWN CRYSTAL RADIO

It's easy and lots of fun to build your own crystal radio set. You need no batteries or tubes when you use a "Melomite" Crystal and detector. Wonderful performance. "Melomite" crystal and detector with instructions and plans for building your own Crystal radio set—All for only 50c postpaid. Rush your order today, immediate delivery. **ALVA ALLEN RADIO, Dept. PM-53, Clinton, Mo.**



LEARN LOCKSMITHING

Learn this fascinating, profitable trade from experts in your spare time at home! Age or physical handicap no disadvantage. Year around, steady income. Full or part time. Practical, illustrated lessons. You can make money even while learning! All materials and special tools supplied without extra charge.

**INSTITUTE OF LOCKSMITHING, Dept. P-52
15 PARK AVENUE RUTHERFORD, N. J.
Lic. by N.J. State Board of Education
Approved for Veterans**



Before You Buy Your Trailer—READ...

TRAILER TOPICS MAGAZINE

It brings you the latest in Trailer Coaches—Equipment—Accessories—Trailer Trips—Trailer Parks and many other interesting monthly features at only—\$3.00 for 2 years.

(6 MONTH TRIAL SUBSCRIPTION \$1.00)

TRAILER TOPICS MAGAZINE (Room 1574)

28 East Jackson Blvd., Chicago 4, Ill.



TRAIN **FASTER**—TRAIN **BETTER**—TRAIN **EASIER**
 IN 10 MONTHS—OR LESS—FOR
RADIO-TELEVISION

Our 21st Year Training Men for Greater Incomes and Security in Radio-Television

I SEND YOU
18 BIG KITS

of Radio Television parts and equipment. Much of your training will be actual construction and experimentation . . . the kind of truly PRACTICAL instruction that prepares you for your Radio-Television career.



Frank L. Sprayberry
 President
 Sprayberry Academy
 of Radio

NEW! NO OBLIGATION PLAN

You Have No Monthly Payment Contract to Sign
 Pay For Your Training as You Earn and Learn

You can get into Radio-Television, today's fastest growing big money opportunity field, in months instead of years! My completely new "package unit" training plan prepares you in as little as 10 months or even less! No monthly payment contract to sign—thus NO RISK to you! This is America's finest, most complete, practical training—gets you ready to handle any practical job in the booming Radio-Television industry. Start your own profitable Radio-Television shop . . . or accept a good paying job. I have trained hundreds of successful Radio-Television technicians during the past 21 years—and stand ready to train you, even if you have no previous experience! Mail coupon and get all the facts—FREE!

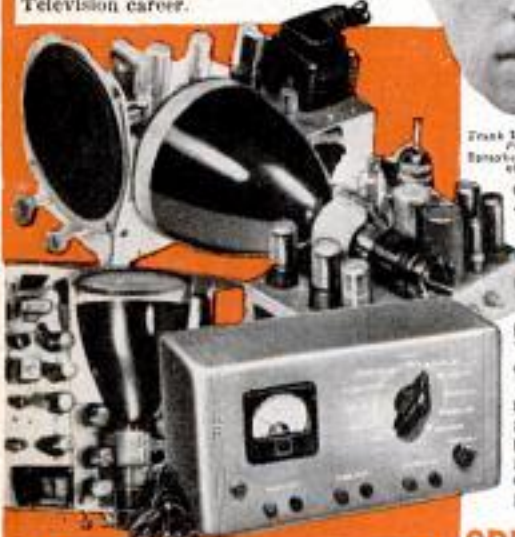

Valuable Equipment Included With Training

The new Sprayberry "package" plan includes many big kits of genuine, professional Radio-Television equipment. You perform over 300 demonstrations, experiments and construction projects. You build a powerful 6-tube 2-hand radio set, multi-range test meter, signal generator, signal tracer, many other projects. All equipment and lessons are yours to keep . . . you have practically everything you need to set up your own profitable Radio-Television service shop.

Earn Extra Money While You Learn!

All your 10 months of training is IN YOUR HOME in spare hours. Keep on with your present job and income while learning. With each training "package" unit, you receive extra plans and "Business Builder" ideas for spare time Radio-Television jobs. New television stations everywhere, open vast new opportunities for trained Radio-Television Technicians—and those in training. If you expect to be in the armed forces later, there is no better preparation than practical Sprayberry Radio-Television training.

YOU BUILD the Television set and the powerful superhet radio receiver shown above IN ADDITION to the other test units shown here. (Many are not illustrated.)

Approved for Veterans under the G. I. Bill

SPRAYBERRY ACADEMY OF RADIO 111 NORTH CANAL ST. Dept. 10-G, Chicago 6, Ill.

MAIL COUPON TODAY! NO OBLIGATION

SPRAYBERRY ACADEMY OF RADIO, Dept. 10-G
 111 North Canal St., Chicago 6, Ill.

Please rush to me all information on your 10-MONTH Radio-Television Training Plan. I understand this does not obligate me and that no salesman will call upon me. Be sure to include 3 books FREE.

Name..... Age.....
 Address.....
 City..... Zone..... State.....

I invite you to get all the facts —

FREE TO YOU 3 BIG RADIO-TELEVISION BOOKS

Rush coupon for my three big Radio-Television books: "How to Make Money in Radio-Television," PLUS my new illustrated Television Bulletin PLUS an actual sample Sprayberry Lesson—ALL FREE. No obligation and no salesman will call. Mail coupon NOW!



SHORTHAND IN 6 WEEKS

WRITE 120 WORDS PER MINUTE
Age No Obstacle — Lowest Cost

Famous Speedwriting Shorthand. No symbols, no machines. Uses ABC's. Easiest to learn and use. Qualify at home in spare time or through classroom instruction. Fast preparation for a better position and a sound, substantial future. Nationally used in leading offices and Civil Service; also by executives, students, etc. 120 words per minute—50% FASTER than Civil Service requirements. Over 200,000 graduates. Typing available.



MASTERS SPEEDWRITING IN A FEW SHORT WEEKS

"In my work as a writer I felt the need for a knowledge of shorthand. After reading a Speedwriting advertisement, I enrolled. In a few weeks I mastered Speedwriting and now it's proving invaluable."—Joseph J. Kudlac, Clifton, N.J.

The very low cost will surprise you
31st Year

Schools in over 400 cities in U. S., Canada,
Cuba and Hawaii.

Write for FREE Booklet to:

Speedwriting

Dept. 1503-4, 55 W. 42 St., N. Y. 36



Men!

Reading This
Message Could Be
the Most Important
40 Seconds In Your Life

From every indication Auto Body and Fender Repair work will continue to be one of America's Big Income fields. Here at U.E.I. we're training men for it—a proven plan that combines spare-time, home study and actual shop practice. Men from coast to coast have successfully completed the U.E.I. course in Auto Body and Fender Repair—many earned money while learning—many now have their own shops. What about you? Isn't this the time for you to see what this big-pay field offers you? Do this: Mail the coupon below and we'll send you our big, descriptive book, "Opportunities." It's Free—Mail the Coupon.

UTILITIES ENGINEERING INSTITUTE, Chicago 14, Illinois
Founded 1927

UTILITIES ENGINEERING INSTITUTE,

2523 Sheffield Ave., Dept. XC-28, Chicago 14, Illinois

Please send, Free, Your Book "Opportunities".

NAME (print) AGE.....

ADDRESS

CITY..... (Zone).... STATE.....

Check here for information if you are under 17.

LOOK BETTER! FEEL BETTER!

USE A Vibrosage ELECTRIC MASSAGER

- Professional-Type
- 4 Scientifically Designed Applicators
- Sanitary

A few minutes daily use of VIBROSAGE gives that stimulating, healthful aid to circulation... relief from aches and pains. Four applicators assure maximum effectiveness for scalp, face and body. Operates on 110 volt, 60 cycle A.C. Five day trial—money-back guarantee! If your dealer cannot supply you, send \$8.50 check or money order, for prepaid shipment. Or, send \$2; pay postman balance plus postage and C.O.D. charges.

BEAUTY APPLIANCE CORP., Dept. V524-C, RACINE, WIS.



GIANT BALLOONS

Surplus U. S. Gov't. (new—orange) NEOPHENE weather, target balloons. For FUN or PROFIT. Great sport in the backyard; or for parties, picnics, dances, fairs. MONEY-MAKERS. Use these balloons to attract crowds to civic events, conventions, exhibitions, trade shows. TERRIFIC for high school and college PROMS. All sizes are approx. inflated size. Postage prepaid on prepaid orders. 18", 3 for 55¢—3 ft. dia. 49¢—6 ft. dia. 99¢ 13 ft. dia. \$1.59 — 20 ft. dia. \$1.95 * Calif. residents please add sales tax.

WAR ASSETS DIV. VOLUME SALES CO.

Dept. M-3-34 3930 Sunset Blvd. Los Angeles 29, Calif.

MAKE BIG MONEY at HOME!

INVISIBLE REWEAVING

Pays up to \$10 in an hour!
Make moth holes, cigarette burns, tears, rips DISAPPEAR from all fabrics. Little-known craft pays big spare-time profits at home. Write today for exciting details FREE!

FABRICON, Dept. 323, 8342 S. Prairie, Chicago 19, Ill.

STUDY AT HOME

WITH AN EDUCATIONAL INSTITUTION

Courses in ARTS AND SCIENCES: Philosophy; Education; Letters; Public Health; Medical Jurisprudence; Psychology; Sociology; Physics; Chemistry; Geology; Pol. Science; Theology; Law; Business and Commerce; Accounting; Mathematics; Statistics; Agriculture. ENGINEERING: Electrical, Civil, Mechanical, Drafting, Architectural, Steam, Diesel, Aeronautical, Radio, Structural, Mining, Industrial, Petroleum, Refrigeration, Chemical. Send for free catalog. McKinley-Roosevelt Incorporated, 4610-N32, Sheridan Rd., Chicago 40, Illinois

SUCCESS • BIG PAY in Aviation MASTER A & E MECHANICS urgently needed

Maximum training in minimum time! Thorough, practical instruction backed by more than 25 years of aviation technical experience. Training authorized under G.I. Bill.

Write today!
Illustrated Catalog
Registrar, Dept. 99,
Miami 30, Florida



TRAIN IN MIAMI -- AIR CAPITAL OF THE WORLD

POPULAR MECHANICS

Cylinders
Pistons
Timing
Clutch
Generator
Cooling
Alignment
Distributor
Universal
Rear end
Ignition
Overhauls
Carburetor
All standard and Automatic transmissions, etc.



**DON'T GUESS!
DON'T WASTE TIME!**
Handle Any Job On
Any Model . . . Slick
As A Whistle!

Fix ANY Car!



Read what to do . . .
SEE exactly how to do it!
Over 1800 big, clear pictures, etc. help you breeze through jobs "slick as a whistle".

It's easy . . . even for beginners . . . to handle anything from tune-ups to complete motor overhauls with this giant, fully approved Chilton Repair Manual.

A tune-up? New piston rings? Ignition or carburetor trouble? Brake or clutch problems? A valve job? Something wrong with power steering or one of those tricky automatic transmissions? . . . Just look up the job you want to fix. This 752-page, 4-pound Chilton Manual tells what to do . . . then shows you simply as A-B-C just how to do it.

No guesswork! No lost time! You handle auto repairs better, easier and faster than you may have dreamed!

THE BIG BOOK SHOWS YOU HOW!

Covers over 1100 models of 20 makes—every model made from 1940 through June 1953. Includes 38,000 specifications and 350 Quick Check Data Tables. Over 1800 clear pictures, diagrams and charts explain things

at a glance. Service short cuts speed work amazingly.

Beginners can handle jobs they may not have thought possible for them. Experienced mechanics save hours, help boost their pay checks to big figures.

COVERS EVERY MODEL

From 1940 to 1953

these makes:

- Buick
- Cadillac
- Chevrolet
- Chrysler
- DeSoto
- Dodge
- Ford
- Frazer
- Henry J.
- Hudson
- Kaiser
- Lincoln
- Mercury
- Nash
- Oldsmobile
- Packard
- Plymouth
- Pontiac
- Studebaker
- Willys



HANDLE JOBS EASY . . . and r-i-g-h-t!

From headlights to transmissions, from motors to ignitions, the Chilton Manual tells everything you need to know . . . even to what tools to use. Jobs are carefully indexed. You find what you want in a jiffy.

Remember! This big manual comes from the world's largest automotive publishers (MOTOR AGE and AUTOMOTIVE INDUSTRIES magazines, the Flat Rate Book, etc.) 19 Chilton experts worked hand in hand with auto

manufacturers to make every job easy for you. Hundreds of thousands of copies are used by the U. S. Armed Forces, by garages, by apprentice mechanics, by students and in vocational schools.

See for yourself without risking a cent. Use manual 10 days—FREE. If it's not all you expect—and more—return it postpaid and DON'T OWE US A PENNY! Send coupon today to Chilton Co., 56th & Chestnut Sts., Philadelphia 39, Pa.

Read what users say!

FAST! "Thanks to the Chilton Manual, I did a job in an hour another mechanic had worked on all day." *Gene Arnold, Iowa*

EASY! "The how-to-do-it pictures are worth the entire price of the manual!" *Merita Wade, Texas.*



**Send No Money
PRACTICE 10 DAYS
FREE!**

NOW! Special Low Cost Manuals on the 3 most popular makes!

- ✓ Ford
 - ✓ Chevrolet
 - ✓ Plymouth
- (incl. Dodge & DeSoto)

Now you can get individual manuals on these three popular makes AT A BIG CASH SAVING! Each contains complete service data on EVERY MODEL of that make from 1940 through June 1953. Each has over 130 pages, hundreds of special photos, charts, diagrams, etc. Only \$2.75 each. Check the one you want in coupon. 10-DAY MONEY-BACK GUARANTEE protects you fully!

THE CHILTON CO., Dept. PM-34,
56th & Chestnut Sts., Philadelphia 39, Pa.

Please send the following manuals (check the ones you want):

- Send the big CHILTON "ALL CARS" REPAIR MANUAL (Price \$7.95; for 10-day FREE EXAMINATION. If I like it, I will promptly remit \$1.95 (plus 50c postage); then send \$2 monthly for 2 months. Otherwise, I will return manual (postpaid) in 10 days and owe nothing.)
- Check here Chilton "CHEVROLET" Manual, price \$2.75 for special Chilton "FORD" Manual, price \$2.75 manuals Chilton "PLYMOUTH, DODGE, DESOTO" \$2.75

NOTE: Above special manuals sold for cash with order (we pay postage). Or, we ship C.O.D. and you pay postman for manual plus post office charges. Specify which method. Any manual returnable postpaid in 10 days and we guarantee to refund your \$2.75.

(OUTSIDE U.S.A.—Cash only. "ALL CARS" Manual, \$6.95. Special Manuals, \$3.00 each. Same 10-day return privilege with money refunded.)

Name _____
Address _____
City, Zone, State _____

own your own business! earn up to
\$75 A DAY CLEAR PROFIT
 in your back yard or basement!

MAKE CONCRETE BLOCKS With Amazing New
 LOW PRICED GENERAL BLOCK MACHINE

NOW! Big Building Boom Profits Within Your Reach
 You don't need much cash to cash in on the building boom! New high speed, low cost General Block Machine produces up to 1,000 concrete blocks a day for homes, factories, buildings, garages. Your profit mark-up is 100% to 150%! Fool-proof, easily operated, sturdy steel machine can make any size from 4" to 12". These superior 3-cure blocks meet all building code requirements for foundation, chimney, corner, sash and many other types of blocks. Works indoors or out. Sand, cement and water available anywhere! Simple operating instructions and mixing formulae for cement and cinder blocks supplied FREE. Get full details, no obligation!



R.I.T. of New York City Reports: "My General Block Machine PAID FOR ITSELF IN FIRST 2 WEEKS!"

Thousands now in use the world over! Write for FREE details TODAY

EXTRA!

Amazing illustrated book gives floor plans for 6 sensational concrete block bungalows. Tells how to lay blocks, lay out building lines, mix concrete, build steps, porch and concrete floors all at great savings. Written by experts. Can save many times the cost of the machine! Get it now! No strings attached.

HOW TO BUILD YOUR OWN CONCRETE BLOCK HOME Only 1/2 Price!

Book sent free if you buy machine. \$1 refunded if you buy later.

GENERAL ENGINES COMPANY

Dept. M-34, 307 HUNTER STREET, GLOUCESTER, N. J.

FREE 1954 CATALOG

WORLD RADIO LABORATORIES

"The World's Largest Distributor of Amateur Radio Transmitting Equipment."

Jam packed with bargains — everything in Radio, TV, and Hi-Fi — for Handyman, Ham, Experimenter or Serviceman!

- Pay Only 10% Down
- Easy Terms
- Liberal Trade-Ins
- Save Over 50% on Used Equipment
- Over 600 guaranteed reconditioned items.



WORLD RADIO LABORATORIES
 3415 W. Broadway — Council Bluffs, Iowa

Leo J. Meyerson

PERSONALIZED SERVICE

MAIL HANDY COUPON

WORLD RADIO LABORATORIES, INC. Dept. PM-3
 3415 W. Broadway — Council Bluffs, Iowa 3'x4' U.S.
 Free 1954 Catalog Used Eq't List Radio Map 25c

NAME _____
 ADDRESS _____
 CITY _____ STATE _____

**WANTED
 MAN WITH CAR**

**No Time Like Now to Get In
 McNess Business**



It's no trick to make good money when you use your car as a McNess "Store on Wheels." Farmers buy everything they can from McNess Men because McNess Products are tops in quality, represent extra value, Attractive business-getting prizes and premiums; also money-saving deals to customers make selling McNess daily necessities a snap.
We Supply Capital—Start Now!
 There's no better work anywhere. Pays well, permanent, need no experience to start, and we supply capital to help you get started quick. You begin making money first day. Write at once for McNess Dealer Book. It's FREE. Tells all—no obligation. (1)
THE McNESS CO., 130 Clark St., Freeport, Ill.

Use Your CAR to Raise Your PAY

EARN WHILE YOU LEARN AT HOME
How to Make Money in PHOTOGRAPHY

If you are OVER 17—good pay, fascinating work await you in photography! Start making money quickly in your own studio or exciting job. LEARN-BY-DOING method trains you at home! Write TODAY for FREE catalog. Also Resident Training, 44th Year! GI Approved.
NEW YORK INSTITUTE OF PHOTOGRAPHY
 Dept. 49, 10 W. 33 St., New York 1, N.Y.

Send for FREE BOOK

REAL ESTATE BE A BROKER

PAYS BIG! SEND FOR FREE, BIG, ILLUSTRATED CATALOG NOW! Graduates report making substantial incomes. Start and run your own business quickly. Men, women of all ages, learn easily. Course covers Sales, Property Management, Appraising, Loans, Mortgages, and related subjects. **STUDY AT HOME** or in classrooms in leading cities. Diploma awarded. Write TODAY for free book! No obligation. Approved for World War II and Korean Veterans
WEAVER SCHOOL OF REAL ESTATE (Est. 1926)
 Suite 300 Law Bldg. Dept. PM Kansas City, Mo.

FREE BOOK TELLS HOW

STUDY AT HOME LAW FREE BOOK!
PREPARE FOR THE BAR

Write today for your copy of our FREE book, "THE LAW-TRAINED MAN," which describes the famous Blackstone home-study course in bar and business law. All needed instruction material furnished including big 16-volume law library. Bachelor of Laws (LL.B.) degree awarded. Moderate tuition; easy monthly terms. Write today.
Blackstone School of Law 225 N. Michigan Ave.
 Founded 1890 Dept. 53, Chicago 1, Illinois



Say You Saw It in Popular Mechanics

INSURED TIRE SERVICE POPULAR BRANDS

FREE INSURANCE POLICY given with each used tire sold. We guarantee the amount of service you pay for.
 Tube Given Free with Each Used Passenger Tire Upon Request

SPECIAL! 10% off on orders for 2 or more used tires

YOU CAN'T LOSE!!

Super Quality — Rugged Performance — 15 Months Insured Service			
600x16	\$4.55	670x16	\$5.25
650x16	4.95	670x18	5.35
650x18	5.45	700x16	5.40
700x16	5.75	700x18	5.75
750x16	6.25	750x18	6.45
800x16	6.75	820x16	7.50
840x16	7.25	820x18	7.50
880x16	7.75	880x18	8.25
900x16	8.25	900x18	8.25
950x16	8.75	950x18	8.75
1000x16	9.25	1000x18	9.25
1050x16	9.75	1050x18	9.75
1100x16	10.25	1100x18	10.25
1150x16	10.75	1150x18	10.75
1200x16	11.25	1200x18	11.25
1250x16	11.75	1250x18	11.75
1300x16	12.25	1300x18	12.25
1350x16	12.75	1350x18	12.75
1400x16	13.25	1400x18	13.25
1450x16	13.75	1450x18	13.75
1500x16	14.25	1500x18	14.25
1550x16	14.75	1550x18	14.75
1600x16	15.25	1600x18	15.25
1650x16	15.75	1650x18	15.75
1700x16	16.25	1700x18	16.25
1750x16	16.75	1750x18	16.75
1800x16	17.25	1800x18	17.25
1850x16	17.75	1850x18	17.75
1900x16	18.25	1900x18	18.25
1950x16	18.75	1950x18	18.75
2000x16	19.25	2000x18	19.25
2050x16	19.75	2050x18	19.75
2100x16	20.25	2100x18	20.25
2150x16	20.75	2150x18	20.75
2200x16	21.25	2200x18	21.25
2250x16	21.75	2250x18	21.75
2300x16	22.25	2300x18	22.25
2350x16	22.75	2350x18	22.75
2400x16	23.25	2400x18	23.25
2450x16	23.75	2450x18	23.75
2500x16	24.25	2500x18	24.25
2550x16	24.75	2550x18	24.75
2600x16	25.25	2600x18	25.25
2650x16	25.75	2650x18	25.75
2700x16	26.25	2700x18	26.25
2750x16	26.75	2750x18	26.75
2800x16	27.25	2800x18	27.25
2850x16	27.75	2850x18	27.75
2900x16	28.25	2900x18	28.25
2950x16	28.75	2950x18	28.75
3000x16	29.25	3000x18	29.25
3050x16	29.75	3050x18	29.75
3100x16	30.25	3100x18	30.25
3150x16	30.75	3150x18	30.75
3200x16	31.25	3200x18	31.25
3250x16	31.75	3250x18	31.75
3300x16	32.25	3300x18	32.25
3350x16	32.75	3350x18	32.75
3400x16	33.25	3400x18	33.25
3450x16	33.75	3450x18	33.75
3500x16	34.25	3500x18	34.25
3550x16	34.75	3550x18	34.75
3600x16	35.25	3600x18	35.25
3650x16	35.75	3650x18	35.75
3700x16	36.25	3700x18	36.25
3750x16	36.75	3750x18	36.75
3800x16	37.25	3800x18	37.25
3850x16	37.75	3850x18	37.75
3900x16	38.25	3900x18	38.25
3950x16	38.75	3950x18	38.75
4000x16	39.25	4000x18	39.25
4050x16	39.75	4050x18	39.75
4100x16	40.25	4100x18	40.25
4150x16	40.75	4150x18	40.75
4200x16	41.25	4200x18	41.25
4250x16	41.75	4250x18	41.75
4300x16	42.25	4300x18	42.25
4350x16	42.75	4350x18	42.75
4400x16	43.25	4400x18	43.25
4450x16	43.75	4450x18	43.75
4500x16	44.25	4500x18	44.25
4550x16	44.75	4550x18	44.75
4600x16	45.25	4600x18	45.25
4650x16	45.75	4650x18	45.75
4700x16	46.25	4700x18	46.25
4750x16	46.75	4750x18	46.75
4800x16	47.25	4800x18	47.25
4850x16	47.75	4850x18	47.75
4900x16	48.25	4900x18	48.25
4950x16	48.75	4950x18	48.75
5000x16	49.25	5000x18	49.25
5050x16	49.75	5050x18	49.75
5100x16	50.25	5100x18	50.25
5150x16	50.75	5150x18	50.75
5200x16	51.25	5200x18	51.25
5250x16	51.75	5250x18	51.75
5300x16	52.25	5300x18	52.25
5350x16	52.75	5350x18	52.75
5400x16	53.25	5400x18	53.25
5450x16	53.75	5450x18	53.75
5500x16	54.25	5500x18	54.25
5550x16	54.75	5550x18	54.75
5600x16	55.25	5600x18	55.25
5650x16	55.75	5650x18	55.75
5700x16	56.25	5700x18	56.25
5750x16	56.75	5750x18	56.75
5800x16	57.25	5800x18	57.25
5850x16	57.75	5850x18	57.75
5900x16	58.25	5900x18	58.25
5950x16	58.75	5950x18	58.75
6000x16	59.25	6000x18	59.25
6050x16	59.75	6050x18	59.75
6100x16	60.25	6100x18	60.25
6150x16	60.75	6150x18	60.75
6200x16	61.25	6200x18	61.25
6250x16	61.75	6250x18	61.75
6300x16	62.25	6300x18	62.25
6350x16	62.75	6350x18	62.75
6400x16	63.25	6400x18	63.25
6450x16	63.75	6450x18	63.75
6500x16	64.25	6500x18	64.25
6550x16	64.75	6550x18	64.75
6600x16	65.25	6600x18	65.25
6650x16	65.75	6650x18	65.75
6700x16	66.25	6700x18	66.25
6750x16	66.75	6750x18	66.75
6800x16	67.25	6800x18	67.25
6850x16	67.75	6850x18	67.75
6900x16	68.25	6900x18	68.25
6950x16	68.75	6950x18	68.75
7000x16	69.25	7000x18	69.25
7050x16	69.75	7050x18	69.75
7100x16	70.25	7100x18	70.25
7150x16	70.75	7150x18	70.75
7200x16	71.25	7200x18	71.25
7250x16	71.75	7250x18	71.75
7300x16	72.25	7300x18	72.25
7350x16	72.75	7350x18	72.75
7400x16	73.25	7400x18	73.25
7450x16	73.75	7450x18	73.75
7500x16	74.25	7500x18	74.25
7550x16	74.75	7550x18	74.75
7600x16	75.25	7600x18	75.25
7650x16	75.75	7650x18	75.75
7700x16	76.25	7700x18	76.25
7750x16	76.75	7750x18	76.75
7800x16	77.25	7800x18	77.25
7850x16	77.75	7850x18	77.75
7900x16	78.25	7900x18	78.25
7950x16	78.75	7950x18	78.75
8000x16	79.25	8000x18	79.25
8050x16	79.75	8050x18	79.75
8100x16	80.25	8100x18	80.25
8150x16	80.75	8150x18	80.75
8200x16	81.25	8200x18	81.25
8250x16	81.75	8250x18	81.75
8300x16	82.25	8300x18	82.25
8350x16	82.75	8350x18	82.75
8400x16	83.25	8400x18	83.25
8450x16	83.75	8450x18	83.75
8500x16	84.25	8500x18	84.25
8550x16	84.75	8550x18	84.75
8600x16	85.25	8600x18	85.25
8650x16	85.75	8650x18	85.75
8700x16	86.25	8700x18	86.25
8750x16	86.75	8750x18	86.75
8800x16	87.25	8800x18	87.25
8850x16	87.75	8850x18	87.75

TRAIN FOR GOOD PAY IN A FIELD THAT ISN'T CROWDED!



**NOW! you can
LEARN ELECTRIC
MOTOR REPAIR**

... A good-paying, modern profession



**OPPORTUNITIES
EVERYWHERE!**

Don't drift into a rut! Don't train for something that everybody and his brother are studying! Consider the facts. . . . The average small home has at least 11 electric motors! Big homes have many more—in phonographs, recorders, oil burners, refrigerators, washers, fans, clocks, mixers, cleaners, air conditioners, etc., etc. Millions more in office, industrial, mining, and transit equipment. Be the well-paid expert who can keep them working!

**FREE
STUDY GUIDE**

A unique Study Guide booklet of 500 practical motor study questions—priced and sold separately at 25c—is yours FREE with your request to examine **ELECTRIC MOTOR REPAIR** book. Makes learning easier—speeds up the work! See coupon.



... for only \$6
FOR THE COMPLETE TRAINING

Every day, more and more electric motors and motor control systems are being used BOTH in industry and in home appliances. The expert who can install and keep them working properly is a valuable man in this Electrical Age. The pay is surprisingly good. The field is tremendous—and growing rapidly. Trained men find opportunities everywhere for full or part time work. **ELECTRIC MOTOR REPAIR**, the big 560-page training course book teaches you the work step by step—quickly and easily—at home in spare time. There is no other book like it. Ideal for beginners or for actual bench use in busy shops. Thousands already in use in leading vocational schools, shops, and for home study.

SHOWS YOU HOW . . . Every Step of the Way!

Based on what you can learn quickly at home from **ELECTRIC MOTOR REPAIR** you can train for prompt, profitable installation, servicing, repairing and complete rewinding of practically any motor in use today. You learn fast! You learn right! Every subject is clearly explained by text AND ALSO by more than 900 illustrations and diagrams. You not only read what to do—you SEE how it is done. Quick reference guides tell you how to handle specific jobs. When a certain motor comes in for repairs, just look it up. **ELECTRIC MOTOR REPAIR** tells you what to do—and exactly how to do it.

ELECTRIC MOTOR REPAIR is designed for use right at the service bench. Unique Duo-Spiral Binding divides the book into two sections so that both text and related diagrams can be viewed together. An instructor standing by your side could hardly do better! **ELECTRIC MOTOR REPAIR** covers the entire field—from alternating- and direct-current motors and generators, etc., to mechanical and electrical and electronic control systems. Right down the line, it explains trouble diagnosing, repair, rewinding and maintenance in a way you can easily understand.

PRACTICE FROM IT 10 DAYS AT OUR RISK!

You don't risk a cent! Use coupon for 10-day examination of this famous home training book.



LEARN FAST . . . No Lessons to Wait for!

If sold as a course and sent to you in lesson form, **ELECTRIC MOTOR REPAIR** would be a bargain at 10 times the price. You get it all at once. You learn rapidly. Here are just a few of the subjects covered:

- Split-Phase Motors
- Capacitor Motors
- Repulsion-type Motors
- Polyphase Motors
- Alternating-Current Motor Control
- Direct-Current Armature Winding
- Direct-Current Motors
- Direct-Current Motor Control
- Universal, Shaded-pole, and Fan Motors
- D-C Generators, Synchronous Motors and Generators
- Electronic Motor Control . . . and essential motor data

10-DAY EXAMINATION COUPON

Dept. PM-34, RINEHART & CO., Inc.,
232 Madison Ave., New York 16, N. Y.

Send me the 560-page **ELECTRIC MOTOR REPAIR** home-training book for 10-day FREE EXAMINATION. At the end of 10 days, I will either return book to you postpaid in good condition or send you the sum of \$4.00 plus a few cents postage in full payment. Include FREE Study Guide which is mine to keep whether I buy the book or not.

Name _____

Address _____

City, Zone, State _____

Your Employer's name & address _____

(Outside U.S.A. \$6.50 each only—some return privileges)



EXPANDING AMERICA Needs DRAFTSMEN Now!



LEARN AT HOME AND GET ON THE SURE ROAD TO BIG MONEY

Today more than ever Draftsmen are needed. America must produce better war and peace time equipment if America's well-being and prosperity is to continue. Draftsmen command big part or full time wages... own tremendous money earning businesses.

VALUABLE EQUIPMENT SENT TO YOU

Everything you need to train at home supplied. Professional set of drafting instruments, all drafting equipment needed and portable drafting table all furnished on **PAY AS YOU LEARN PLAN**. RUSH name today for **FREE Book**.

CHRISTY TRADES SCHOOL, 4804 N. Kedzie, Dept. DB-2503, Chicago

SEND FOR Free Record START SPEAKING SPANISH OR FRENCH

ALMOST OVERNIGHT!



MORE MONEY



NEW CAREER



TRAVEL FUN

HERE'S the easiest way to learn a new language. Listen to **FREE** 2-sided non-breakable record. Let your eyes follow words in **FREE** sample lesson. Almost at once you'll be chatting whole sentences in your new language with a *perfect accent!* There are no "strings" to offer. But it may end soon. Rush name, address with 25c to help cover cost of special packaging, shipping of free record, lesson. State language you want. We'll also send free information on full Cortina course. No obligation.

CORTINA ACADEMY

"Originators of the Phonograph Method"
Dept. 643, 138 W. 52nd St., New York 19, N.Y.

Also:
GERMAN
ITALIAN
RUSSIAN
JAPANESE
BRAZILIAN

Over \$450⁰⁰ Profit!

I SOLD 67 D-FROST-O-MATICS IN JUST 5 DAYS
SPARE TIME!



Get the EXTRA MONEY YOU want this Easy Way!

Amazing D-FROST-O-MATIC Makes Any Electric Refrigerator Self-Defrosting! Bill Carney is just one of thousands of alert men, all over America, who have found money-making "magic" showing housewives how amazing D-FROST-O-MATIC ends messy, time-wasting hand defrosting forever. Bill Carney's record is exceptional—but our sure-fire **FREE TRIAL PLAN** can pay YOU up to \$20.00 a week on just five easy sales a day! You just plug in D-FROST-O-MATIC, tell the housewife "Try it before you buy it". When she sees how D-FROST-O-MATIC saves time... work... food... and money **SHE WON'T LET YOU TAKE IT OUT.**

RUSH NAME TODAY... for PROFIT Details and FREE TRIAL PLAN!

"Anyone Can Sell Them"
"You just place them in homes. D-FROST-O-MATIC does the rest. My profit has been several times over what I hoped for."
—Bill Carney, Mo.

More than 29,000,000 prospects waiting! Rush your name and address today. We'll furnish exciting facts, proof and sure-fire Free Trial plan. No obligation. Send your name and address today.

D-FROST-O-Matic, Dept. M-6
173 W. Madison St., Chicago 2, Illinois
In Canada: **SILVEX CO., Ltd.**,
271 Dowd Street, Montreal 1, Quebec

ENGINEERING DEGREE IN 27 MONTHS

INDIANA TECHNICAL COLLEGE

B. S. DEGREE, Aeronautical, Chemical, Civil, Electrical, Mechanical and Radio Engineering (inc. TV and Electronics). Drafting, 1-yr. G.I. Gov't. approved. Low rate. Earn board. Large industrial center. Students from 48 states, 21 countries. Demand for graduates. Enter March, June, September, December. Write for catalog, 1634 E. Washington Boulevard, Fort Wayne 2, Indiana.



Make BIG MONEY!

RAISE CHINCHILLA RABBITS!

Cash Markets Supplied for Your Production
FREE - Illustrated Booklet - WRITE TODAY!
ROCK HILL RANCH, SELLERSVILLE 36, PA.
World's Largest Breeder of Chinchilla Rabbits

BUILD LUGGAGE AT HOME WE SELL YOUR PRODUCTS!

ONLY NEW HOME MONEY-MAKING PLAN IN YEARS!

Make Luggage and cases for traveling, photographers, musicians, salesmen, electronics, tools, portables, 1001 other items. Also repair Luggage. No special equipment needed. **BIG Profits!** We supply complete instructions—everything. Write for free details and Business Plan. **ABARSI CASECRAFT, Dept. H8,** 805 W. Sunset Blvd., Los Angeles 12, Calif.

Say You Saw It in Popular Mechanics

WELD YOUR WAY AHEAD!

Learn Arc and Gas Welding In Spare Time

Your opportunities are greater when you learn to use this great tool of modern industry. Training in welding opens the door to many key industries. Now you can train at home with **UEI's** practical course. Includes techniques, metallurgy, blueprints, shop practices, other important phases.



Write For **FREE Facts!** You can follow home-study training with actual shop practice. High school diploma not necessary. Write **NOW!**

UTILITIES ENGINEERING INSTITUTE

2523 Sheffield Ave., Dept. WC-6, Chicago 14, Ill.



WANT MORE PAY? MORE SECURITY? A JOB WITH FUTURE UNLIMITED?

VETERANS! CIVILIANS! NO EXPERIENCE NECESSARY!

Go Into TELEVISION

I'll train you at home... in your spare time

for better-pay jobs in TV

L. C. Lane, B.S., M.A.
President: Radio-Television Training Association
Executive Director: Pierce School of Radio & Television

LEARN MORE

I give you ALL the practical training you need to qualify for the highest-paid technician jobs in TV.

RADIO-FM-TV TECHNICIAN TRAINING

No experience necessary! You learn by practicing with equipment I send you. It's easy! I give you the same successful guidance that has helped hundreds of men towards a TV career. Many started with only grammar school training.

FM-TV TECHNICIAN TRAINING

Saves you months if you have previous Armed Forces or civilian radio experience! Train at home. I give you kits, plus equipment to build BIG SCREEN TV RECEIVER, and FREE FCC COACHING COURSE! Everything AT NO EXTRA COST!

OPTIONAL: TWO WEEKS TRAINING IN NEW YORK CITY AT NO EXTRA COST!

You get two weeks, 50 hours, of intensive Laboratory work on modern electronic equipment at our associated school in New York City — Pierce School of Radio and Television. And I give you all this AT NO EXTRA COST whatsoever, after you finish your home study training in the Radio-FM-TV Technician course and FM-TV Technician Course.

FREE FCC COACHING COURSE!

Important for BETTER PAY JOBS requiring FCC License. You get this training AT HOME and AT NO EXTRA COST! Top TV jobs go to FCC licensed technicians.

NEW! PRACTICAL TV CAMERAMAN & STUDIO COURSE!

(For men with previous radio and TV training)

I train you at home for an exciting high pay job as the man behind the TV camera. Work with TV stars in TV studios or "on location" at remote pick-ups! A special one-week course of practical work on TV studio equipment at Pierce School of Radio & TV, our associate resident school in New York City, is offered upon your graduation.

VETERANS!

MY SCHOOLS FULLY APPROVED TO TRAIN VETERANS UNDER NEW G.I. BILL! If discharged after June 27, 1950 — CHECK COUPON! Also approved for RESIDENT TRAINING in New York City at Pierce School of Radio and Television... qualifies you for full subsistence allowance up to \$160 per month. Write for details.

RADIO-TELEVISION TRAINING ASSOCIATION

52 EAST 19th STREET, NEW YORK 3, N. Y.

Licensed by the State of New York • Approved by the VA

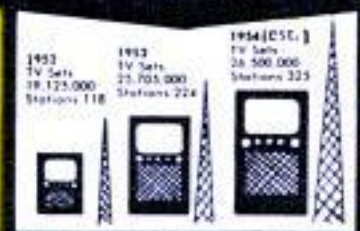

PROOF! TV NEEDS THOUSANDS OF TECHNICIANS!

TV is coming into practically every community. More than 2,000 new TV stations authorized in this country alone! Thousands of new studios being planned and built. All kinds of new equipment coming on the market. Millions of new TV-set owners will need servicing. It's the rich field of the future with money-making opportunities NOW... if you get in on the ground floor. There just won't be enough TV Technicians to go around. It's your chance of a lifetime for GOOD EARNINGS in a TOP JOB or YOUR OWN BUSINESS!

Public Address System



C-W Telephone Transmitter



Combination Voltmeter-Ammeter-Ohmmeter



Super-Het Radio Receiver



RF Signal Generator

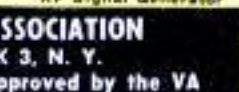

EARN MORE

MORE MONEY AND A CAREER ARE WAITING FOR YOU HERE!

Earn while you learn by repairing TV sets for friends and neighbors. Many of my students make up to \$25 a week in spare time... pay for their entire training this way... start their own money-making service business. When they complete training and go into TV full time, their earnings zoom into big figures! My graduates are now working at RCA, NBC-TV, CBS-TV, DUMONT TV and numerous other TV studios and plants.

GET MORE

Enough equipment to start your own home Laboratory! You learn by doing. I give you ALL the equipment. You build and keep a professional GIANT SCREEN TV RECEIVER complete with mammoth picture tube (takes any size up to 21 inch)...



...also a Super-Het Radio Receiver, RF Signal Generator, Combination Voltmeter-Ammeter-Ohmmeter, C-W Telephone Transmitter, Public Address System, AC-DC Power Supply, and more! 15 full Kits! All tubes supplied, too!

YOU GET ALL 4 FREE!

Just by mailing coupon. Try the Sample Lesson. Read how and where you can make big money in TV... easily!



MAIL THIS COUPON NOW! No Salesman Will Call!

Mr. Leonard C. Lane, President
RADIO-TELEVISION TRAINING ASSOCIATION
52 East 19th Street, New York 3, N.Y., Dept. M-3B
Dear Mr. Lane: Mail me your NEW FREE BOOK, FREE SAMPLE LESSON, and FREE aids that will show me how I can make BIG MONEY IN TELEVISION. I understand I am under no obligation and no salesman will call.
(PLEASE PRINT PLAINLY)

NAME _____ AGE _____
ADDRESS _____
CITY _____ ZONE _____ STATE _____

I AM INTERESTED IN:
 Radio-FM-TV Technician Course
 FM-TV Technician Course
 TV Cameraman & Studio Course
 VETERANS! Check here for Training under NEW G.I. Bill

**\$100.00 Profit
In My First 3 Days!**

—that's what Leon Landis, Michigan, reports. Many others are "cleaning up" showing the amazing new PRESTO. So can YOU!



Amazing new kind of fire extinguisher. Tiny "Presto" (about size of a flashlight!) does job of bulky extinguishers that cost 4 times as much, are 8 times as heavy. Ends fires as fast as 2 seconds. Fits in palm of hand. Never corrodes. Sells for only \$3.98. Guaranteed for 20 years! 2 million already sold! Show it to civil defense workers, owners of homes, cars, boats, farms, etc.—and to stores for resale. Make good income. H. J. Kerr reported \$20 a day. Wm. Wydallis, \$15.20 an hour. Write for FREE Sales Kit. No obligation.



Science's
New Midget
Miracle
"PRESTO"

MERLITE INDUSTRIES, Dept. 53
114 East 32nd Street New York 16, N. Y.
IN CANADA: Mopa Co., Ltd., 371 Dowd St., Montreal
1, P. Q. (If you want a regular "Presto" to use as a
demonstrator, send \$2.50. Money back if you wish.)

GREER SHOP TRAINING
2230 So. Michigan Blvd.
Chicago 16, Illinois

**Leader in Practical
Training for 50 Years**

Gain success by learning a trade offering security and high pay—go into business for yourself.

Get the "Know-how" at Greer

You learn in our new, large, modern shops by working with latest tools and equipment of the trade — tear down, inspect, repair and rebuild... under supervision of experts. Greer founded 1902. Over 51,000 successful grads. Part time, full time, day and evening. E-Z terms. Mail coupon today.

CLIP COUPON . . . MAIL TODAY

Greer Shop Training—2230 South Michigan
Chicago 16, Illinois Desk 213

Please send information about trade checked:

- | | |
|---|---|
| <input type="checkbox"/> In our Chicago Shops: | <input type="checkbox"/> Auto Mechanics |
| <input type="checkbox"/> Body, fender Repair | <input type="checkbox"/> Diesel Mechanics |
| <input type="checkbox"/> Welding—Arc, gas | <input type="checkbox"/> Tool & Die |
| <input type="checkbox"/> Refrigeration & Air-conditioning | <input type="checkbox"/> Machinist |
| <input type="checkbox"/> Machinist | <input type="checkbox"/> Piano tuning |

APPROVED FOR CIVILIANS and G.I.'s
(check which)

ATTENTION: HIGH SCHOOL GRADUATES.
Write for information on 2 year DIESEL-
AUTOMOTIVE ENGINEERING COURSES.

Name _____

Address _____

City _____

State _____ Age _____



INVENTORS

IF YOU WISH TO PROTECT YOUR INVENTION, You should take steps to protect it by a U. S. Patent. Write me for "INVENTION RECORD" form

CARL MILLER
REGISTERED PATENT ATTORNEY

WOOLWORTH BLDG., 35th FLOOR, 34A
NEW YORK CITY

PATENTS
C. A. SNOW & CO.
REGISTERED PATENT ATTORNEYS
WRITE FOR INFORMATION TO
428 SNOW BUILDING, WASHINGTON 1, D. C.

INVENTORS

Whether an invention is patentable can be substantially determined by a search of the U. S. Patent records. Without obligation, write for information explaining the steps you should take to secure a patent.

JOHN N. RANDOLPH
Registered Patent Attorney
201 Columbian Building, Washington 1, D. C.

HELPFUL BOOKS

Send post card asking for FREE catalog
Popular Mechanics Press, 200 E. Ontario, Dept. 601, Chicago 11

INVENTORS

Send for PATENT INFORMATION REGISTERED PATENT ATTORNEY Book and INVENTOR'S RECORD Patent Attorney & Advisor without obligation U. S. NAVY DEPT. 1930-1947
GUSTAVE MILLER ASSOCIATE EXAMINER U.S. PAT. OFF. 1923-1929
34-PM WARNER BUILDING WASHINGTON 4, D.C. PATENT LAWYER

**INVENTIONS
WANTED**

If you want to market, or sell, your invention for cash or royalties, Write for our Free Booklet. Send no drawings. We also welcome hearing from firms, or private capital, wishing to review inventions in any field. We will be glad to send notice of our clients' inventions.

GLOBAL MARKETING SERVICE
1404 Mitchell Street Dept. PD Oakland 1, Calif.

INVENTORS

I shall be pleased to furnish you, upon request, with full information relative to patent procedure—without any obligation on your part.

PATRICK D. BEAVERS
Registered Patent Attorney
934 Columbian Building Washington 1, D. C.

YOUR SPARE TIRE IS WORTH \$25,000

DEMONSTRATING NAT'LY ADVERTISED PUNCTURE-PROOF SAFE-T-GARD

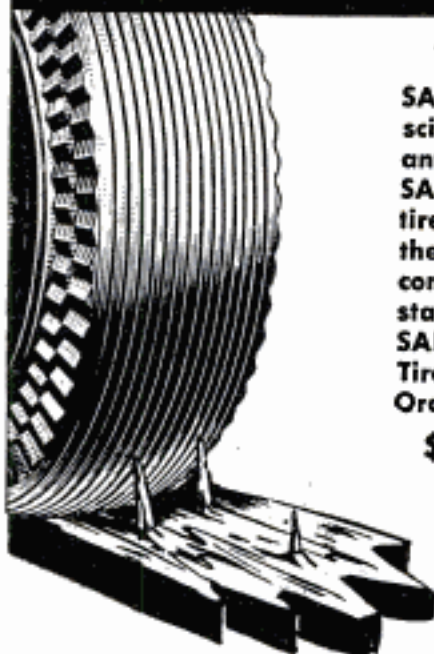

WHAT IS SAFE-T-GARD ?

SAFE-T-GARD is a revolutionary, new scientific product that puncture-proofs any ordinary tire. All you do is inject SAFE-T-GARD into the air valve of the tire. You don't even have to remove the tire from the wheel! This miracle compound coats the inner tube instantly sealing off all punctures! SAFE-T-GARD Puncture Proofs Four Tires For Less Than The Cost Of One Ordinary Puncture Proof Tire!

\$1.98 per tire - \$7.92 for 4 tires

A MONEY MAKING BUSINESS FOR YOU —

Fill your spare tire with SAFE-T-GARD. By the way, SAFE-T-GARD will make spares obsolete. Now put the tire on any wheel and drive your car 25 miles. You have just puncture proofed your tire. Prove it by driving a spike into the tire. You won't lose one cubic inch of air! Amazing, but SAFE-T-GARD has been laboratory and road tested.

Now, any salesman will recognize the tremendous value of a demonstration like this. You'll prove to car owners, fleet, truck and cab operators, that SAFE-T-GARD works with one of the most dramatic sales demonstrations possible! Every owner will leap at this PROVEN opportunity to puncture proof his tires for as little as \$1.98 each.

SAFE-T-GARD PRODUCTS, INC.
432 Fourth Ave., New York 16, N. Y.

YOU CAN MATCH THESE ACTUAL EARNINGS FOR YOURSELF



Mike Roberts
Cleveland, Ohio
"I made \$527 the first week hitting the major service stations in my area."



John Hohlstein
Meriden, Conn.
"I have been averaging \$85.00 per week selling in my spare time."

NATIONAL ORGANIZATIONS WRITE ABOUT SAFE-T-GARD

Sears Roebuck & Co.
(Educational Division)
El Paso, Texas
Gentlemen:

I put 15,000 miles on my car in four months. I feel SAFE-T-GARD is not only the best but much the cheapest method of puncture proofing tires.

Yours truly,
F. H. Newton
District Manager

YELLOW CAB CO.
Lincoln 8, Nebraska
Gentlemen:

We just finished a very busy week-end with a big football crowd in the city, and no flats. Not one driver lost a minute because of a flat. Ordinarily, we would have had at least fifteen.

Respectfully yours,
Yellow Cab Co.
E. E. Strube, Gen'l Mgr.

GET STARTED NOW — DON'T MISS SPRING AND SUMMER DRIVING MONTHS!

You'll agree that this is a square and fair proposition. Send \$5.00 (Refundable Deposit) for a supply of nationally advertised SAFE-T-GARD to puncture proof the 4 tires on your own car and begin your sales demonstrations. Just as soon as you have ordered 36 units of miracle SAFE-T-GARD your five dollar deposit will be refunded. As a successful member of our organization you puncture proof your tires at company expense! Preference given to sincere men... get your refundable deposit on the books now.

NOT ONLY A SURE-FIRE PROVEN PRODUCT—BUT NATIONWIDE MILLION DOLLAR ADVERTISING AND PROMOTION TO MAKE SALES FOR YOU!

NATIONAL SAFE-T-GARD Consumer Contest... and Recorded SAFETY Spot Announcements Waiting for Local SAFE-T-GARD Sponsorship in Your Territory!



You'll Cash In On The Name Value Of These Stars Of Radio, Stage and Television —



Sammy Kaye Mel Allen
Don McNeil, Faye Emerson, Rocky Marciano, George Jessel, Jinx Falkenburg, Red Burtons, John Reed King, Jackie Gleason, And Others.

SAFE-T-GARD PRODUCTS, INC.
432 Fourth Ave., Dept. PM-3
New York 16, N. Y.

GUARANTEED

It is understood that I get preferred treatment. I want to get in on the ground floor of this great money-making proposition.

- Enclosed is \$5.00 refundable deposit for a supply of nationally advertised SAFE-T-GARD to puncture proof the 4 tires on my own car. Also include complete sales kit so I can save time and go right to work taking orders.
- I want more information on SAFE-T-GARD.

Name.....

Address.....City.....Zone.....State.....

In 10 Minutes of **FUN** a day I changed myself from this Bloodless, Pitiful **SKINNY SHRIMP**



Ken GRIMM AFTER MAKING COUPON

TO THIS Ken Grimm BEFORE mailing coupon

NEW MUSCULAR RED-BLOODED HEAD-TO-TOE HE-MAN!

Now, Buddy YOU Mail the Coupon below as I did! May be LAST CHANCE before \$1 price goes back!

GET ALL THESE PICTURE-PACKED COURSES **FREE**

if you mail coupon NOW!

I just GAINED 35 NEW LBS. OF SHAPELY POWER-PACKED MUSCLES!

You can do the same as I and THOUSANDS have.

You can add 10 inches to your CHEST 6 inches to each ARM and the rest in proportion as I did.

NO! friend you don't have to be SKINNY, WEAK or FLABBY any more just mail NOW the FREE coupon below as I did.

Besides getting ALL 5 Courses (pictured on this page) FREE (Millions Have Been Sold for \$1.) You'll ALSO get FREE a big BOOK OF PHOTOS OF STRONG MEN and BOYS who were WEAKLINGS like you BEFORE mailing coupon. This Thrilling Book Will Also Tell You



HOW YOU CAN WIN A BIG 15" TALL SILVER CUP as I just did and how to WIN \$100.



LAST CHANCE - ALL FREE COUPON!

1. Photo Book of STRONG MEN
2. MUSCLE METER 3. FIVE COURSES

Dept. PM-43

Tell Me How To WIN \$100, etc.

Jowett Center
Headquarters in
World for
Building
All-Around
MEN!
-F. F. Kelly
Physical
Director

JOWETT INSTITUTE OF PHYSICAL TRAINING
220 FIFTH AVENUE, NEW YORK 1, N. Y.
Dear George, Please mail to me FREE Jowett's Photo Book of Strong Men and a Muscle Meter, plus all 5 HE-MAN Building Courses: 1. How to Build a Mighty Chest, 2. How to Build a Mighty Arm, 3. How to Build a Mighty Grip, 4. How to Build a Mighty Back, 5. How to Build Mighty Legs—Now all in One Volume "How to become a Mighty HE-MAN." ENCLOSED FIND 10c FOR POSTAGE AND HANDLING (no C.O.D.'s).

NAME _____ AGE _____
ADDRESS _____
CITY _____ ZONE _____ STATE _____

LOW OVERHEAD-LARGE VOLUME SALES & SMALL PROFITS BRING YOU THESE "LOWEST PRICES."
WHAT GOOD IS A TIRE WITHOUT A TUBETUBE FREE WITH EVERY TIRE AT NO EXTRA COST
WHY PAY MORE!
AN ESTABLISHED POLICY OF CAREFUL SELECTION ASSURES YOU, MANY HAPPY MILES. BE WISE—TRY ONE—YOU'LL BUY MORE! WE WELCOME COMPETITION. NO ONE CAN TOUCH OUR QUALITY & PRICE!
YOU GET WHAT WE ADVERTISE
GOOD USED TIRES - NOT RECAPS - NOT RETREADS
WINTER SPECIALS—SEND THIS AD EVERYBODY MAY TAKE **10% off** ON EVERY TIRE
20 MONTHS WRITTEN GUARANTEE



600-16	\$3.42	830-16	\$4.82	800-20	\$6.52	32x6(R)	\$8.02
650-16	4.12	700-15	3.82	650-20	7.02	32x6(10)	9.02
700-16	4.32	670-15	3.82	700-20	7.92	900-20	13.22
650-15	3.72	710-15	4.12	750-20	8.02	1000-20	13.12
760-15	4.32	850-17	4.32	825-20	13.02	1100-20	13.02

Specialists in Truck Tires—Selected for Toughest Jobs—Tops in Value
EXTRA SPECIAL—30 MONTH WRITTEN GUARANTEE—FREE TUBE
600-16 \$5.12 475-16 \$4.72 700-16(8) \$8.52 700-20 \$10.82
600-16(6) 6.32 640-16 4.82 750-16(8) 10.82 750-20(10) 13.32
650-16 5.62 670-15 5.32 700-17 9.82 750-20(8) 11.02
650-16(6) 7.22 710-15 5.42 750-17 11.02 825-20 18.02
700-16 6.12 760-15 5.82 750-15 10.52 900-20 17.02
750-16(6) 8.62 800-15 6.32 825-15 12.62 1000-20 17.82
825-16 4.62 820-15 6.32 900-20 8.52 1100-30 17.02
850-17 4.62 670-16 6.22 650-20 9.92 1100-32 18.32
850-15 5.12 760-16 7.12 32x6(R) 11.02 1000-32 18.22
700-15 8.22 760-16(6) 7.32 32x6(10) 13.12 1100-34 19.82
ALL WHITE WALLS \$1.00 extra (Military tread) 750x20—\$14.02

Thousands of tires shipped all over U.S.A. All tires shipped F.O.B. Phila. Send Check or M.O. with this ad. Dept. 2.
STANDARD 834 N. Broad St., Philadelphia 30, Pa.

GROW ORCHIDS AT HOME
BIG PROFITS!! SPARE-FULL TIME
World's most thrilling hobby—profitable home business. Single Orchid plant may multiply into many—each as valuable as the first. Successful home grower shows you how! Raise gorgeous Cattleyas, Cymbidiums, Epidendrums, on living-room table. Big-profit orders come from friends, neighbors, florists, etc.—also Mail Orders. Illustrated secrets of the experts in simple "show-how" language AND blooming-size orchid plants sent at NO RISK. Everything you need to start—for pleasure or profit. FREE—full details—SEND NO MONEY. Write today. TROPICAL FLOWERLAND, Dept. 313, 4622 Wilshire Blvd., Los Angeles 5, California

STUDY INDUSTRIAL DESIGN

You can train at Art Center School in California with practicing-professionals for upper-level jobs in INDUSTRIAL DESIGN. Recent graduates have been added to the staff at General Motors, Chrysler, Raymond Loewy, Henry Dreyfus, etc. Majors in transportation, general product design, structures, community development, furniture design, packaging, display, 4-year degree courses. Learn to combine imaginative design with technical proficiency, coordinate utility and beauty. Stimulating environment. Field trips. Advantages of mild Southern California climate and nearby holiday spots. Coed. Placement service. Write for catalog.

ART CENTER SCHOOL, Edward M. Adams, Director
8353 WEST THIRD STREET, LOS ANGELES 5, CALIFORNIA

Broken or Loose FALSE PLATE?

Fix it Yourself EASILY in a Few Minutes
Your plates may become broken or loose just when you need them most. With FIX-IT-KIT you can repair your own broken plates. Also tightens loose fitting plates, easily. Get permanent comfort with professional material. Complete instructions. Satisfaction guaranteed or your money refunded. Order Now at a new low price only \$2.98 postpaid—or sent C.O.D.
DENT-FIX DENTAL PRODUCTS, Box 674, Dept. PM-3, Kansas City 8, Mo.

BRAND NEW NYLON COVERS
for outdoor storage of cars, boats, machinery, equipment, etc.
Strongest, lightest cover ever made. New DuPont Nylon with 1 side rubberized and the other of soft nylon, cannot scratch car surface. Will not harden, crack or mildew. Secured with heavy elastic and brass grommets. Protection against wind, rain, sun, snow, frost, etc. 15-day money-back guarantee. Material very many times stronger than regular plastics. Olive green color.
Nylon tarps to order, heavier weight, double coated, 8 oz., brass grommets, 25c sq. ft. Size 8' x 12' \$17.95 plus 90c postage
DEFENDER TEXTILE CORP., 425 N. Hwy, Dept. PM-3, N. Y. 13, N. Y.

Learn BAKING At Home
Baking is one of America's high industries in wages. Nearly depression-proof. Thorough basic home course lays sound foundation. If you have aptitude, write for FREE BOOKLET. Opportunities in Commercial Baking.
NATIONAL BAKING SCHOOL
835 Diversey Parkway Dept. 1353 Chicago 14, Ill.



IN PAN-AMERICAN ROAD RACE, "toughest 2,000 miles in the world," thirty leading contenders selected Life-time for their cars, had no trouble, although other cars dropped out due to battery failure. Small stock car winner C. D. Evans said: "most rugged battery I've ever seen."



SCIENCE AND CHEESE CAKE were combined in another test, where Life-time battery was run down completely, then lowered into tank of water and frozen solid. Six weeks later, still in cake of ice, battery was connected to heavy truck motor, started it immediately.

The Battery That Wouldn't Give Up

Run down, baked, frozen, it keeps bouncing back to life. Six-year bonded* guarantee rocks billion dollar industry.

Heralded as the "battery with 753 lives" a new American battery has defied the determined efforts of automotive editors and researchers to make it give up.

Run down, charged, run down and charged from 604 to 1142 times in S.A.E. tests, it keeps coming back for more.

In one test, the Life-time battery beat (by a narrow 24% margin) a famous German battery rumored to be postwar "super battery."

Over 58,000 foot-pounds of power—enough to lift an automobile 15 feet straight up—is developed by the Life-time battery. Tremendous power reserve accounts for battery's performance from 35 below to 160 in the shade.

For cars and trucks, the Life-time battery sells in all 6-volt sizes for \$29.95, in 12-volt sizes for \$34.95. Special sizes are made for marine and industrial use.

For name of nearest dealer or distributor, write Continental Manufacturing Corporation, Dept. PM-3 Washington Blvd. at Motor Ave., Culver City, Calif.

*Six-year guarantee backed by multi-million-dollar bonding company.

WANTED: Life-time Battery Distributors, Dealers, Regional Managers

Frankly, we have a problem. Every day, letters and wires pour in asking for the name of the nearest Life-time battery dealer—so many, in fact, that we need more dealers to handle the demand. These new customers have seen our full-page advertisements in *Look*, *True*, *Argosy*, *Esquire* and about thirty other magazines. Or they have seen or heard our television and radio broadcasts of international sporting events like the Pan-American Road Race. Now, the same mail brings requests for Life-time battery dealerships.

The answer seems simple: appoint these dealers to take care of our new customers—but it isn't that easy. We need men with executive ability who can qualify as regional managers to help us decide which dealers should be appointed in the fastest-growing organization of its kind in the world. We also need distributors to handle warehousing and administration for our dealer network. If you have organizational ability and are financially responsible, we'd like to hear from you and discuss your opportunities with us.

Continental Manufacturing Corporation, Dept. PM-3 Washington Boulevard at Motor Avenue, Culver City, California

FOR YOUR TECHNICAL AND VOCATIONAL TRAINING

Come to the
UNIVERSITY OF HOUSTON

One of America's large and most modern universities. Select from these fascinating fields: aeronautics air conditioning & refrigeration auto body and paint auto mechanics auto upholstery & trim diesel drafting electricity electronics machine shop photography radio stationary engineering television welding woodworking furniture upholstery.

PREPARE FOR YOUR FUTURE NOW . . . with very latest methods and equipment, at modern U. of Houston College of Technology. Entrance: high school diploma, or over 18 and ability to profit from instruction. Beautiful campus—250 wooded acres in Houston, Texas—city of tomorrow. Pull college activities, sports, social life. Day or night, short or longer courses. Co-op work-study programs . . . earn part of tuition and expenses with part-time job in your own career field, while you learn. Personal vocational counselling. Diploma on completion and all credits apply towards Bachelor of Applied Science Degree. Job placement assistance, Feb., June, Sept. semesters. Mail ad now for Free fully-illustrated brochure. No obligation. Mark X before choice of subject. Do it today!



ADMINISTRATION BUILDING

University of Houston, College of Technology
Dept. 134 — HOUSTON 4, TEXAS

Sworn statement from Charles Lemming reads:

"After starting my own business,
I've averaged

\$100 A DAY

—most of it clear profit!"

Not everyone does as well . . .
Mr. Lemming owns 2 machines

• In small city, Mr. Lemming started his own business, averaged \$100 a day during first year. Many have succeeded. For example, George Held grossed \$350 in single week.

• How much you earn depends largely on you. No special skill, no large investment. Can start spare time until full time available.

No shop necessary. Operate from home. Clean upholstered furniture on customers' premises—homes, hotels, motels, etc. Auto upholstery, too. Profits high.

• To be free of bosses, layoffs, start your own successful business. Mail coupon today.

SEND COUPON TODAY FOR FREE BOOK

• **VON SCHRADER MFG. CO.**

• 1310 "D" Pl., Racine, Wisconsin

• Please rush your FREE booklet telling how I can start my own profitable, year-round electric Upholstery-Cleaning business. Request incurs no obligation.

• Name _____

• Address _____

• City _____ Zone _____ State _____



**ITALIAN ACCORDIONS
AT LOWEST
WHOLESALE
PRICES**

**5-DAY
FREE
TRIAL**

**"PAY AS
YOU PLAY"**

Small Down Payment

As Little As

\$10 per month

**DIRECT from
Importer to You!**

SATISFACTION GUARANTEED, or your money back! NOW you can save up to 50% by direct purchase from America's leading distributor of famous genuine ITALIAN ACCORDIONS. TRADE-INS ACCEPTED

Send for FREE Illustrated Catalog!

ACCORDION MANUFACTURERS & WHOLESALE OUTLET

2003 West Chicago Ave. Dept. R-34, Chicago 22, Ill.

**I'll Send You This Handsome
SAMPLE CASE—FREE**



and Show You How to Make
Up to \$15.00 in a Day

WRITE for this FREE Tailoring Sample Case packed with 100 beautiful, big-value suit and overcoat fabrics. Take orders from friends, fellow-workers, others, for fine quality, made-to-measure clothes. Pocket big cash profits in advance. Because wearing our suits and overcoats brings more orders, we make it easy for you to get your own clothes without 1c cost. No experience is needed. **SATISFACTION GUARANTEED.**

SEND NO MONEY. Rush your name, address, and age—today!

**PROGRESS TAILORING COMPANY, Dept. H-216
500 SOUTH THROOP STREET - CHICAGO 7, ILLINOIS**

Learn CARTOONING

at home in spare time . . . the quick easy London Picture Chart way. Teaches how to originate—today's big need. Scores of successes. Send 10c for Picture Chart (to test ability) and full details. Please state age.

London School of Cartooning, 1503 CT5 Bldg., Cleveland 14, O.



TOOTHACHE?

Ask your Druggist for **DENT'S**

**TOOTH GUM
TOOTH DROPS
POULTICE**

TASOPE PHOTO-ENGRAVING PLANTS

Establish your own profitable **PHOTO-ENGRAVING** business. Make cuts for newspapers, printers, and advertisers. Make etched name plates, plaques etc. Instructions furnished, no experience necessary. Sold direct from factory since 1931. First five hundred cuts sold locally or by mail will pay for plant and pay you well for your time. Write for FREE catalog.

TASOPE, DEPT. PM3, AURORA, MO.

**YOU CAN FIND
GOLD - SILVER - TREASURE**

with our new, super-sensitive Metal Detectors. New, field-proved Geiger Counters for uranium, Mineralights for Tungsten. Free Information.

**THE DETECTRON CORP. - Dept. PM-3
5420 N. Vineland, N. Hollywood, Calif.**

250 POWER

**Complete
Telescope Lens Kit only \$3.49 postpaid**

Conquer Space. Explore the Universe, Planets, Moon Craters, New Stars, etc. Complete Lens Kit consists of 80 inch focal length ground and polished objective lens, eyepiece lenses for 30 POWER, 100 POWER, 150 POWER, 200 POWER, 250 POWER, and all necessary lens fittings. Easy to make from simple step by step instructions. (Tripod and mount not included.) Money back guarantee.

BUSSE SALES CO., Hartford, Conn., Dept. PM 19

MILLIONS OF APPLIANCES NEED REPAIR!

EARN BIG MONEY.. WORK PART OR FULL TIME IN ELECTRIC APPLIANCE REPAIRING!

ELECTRIC REFRIGERATORS

WASHING MACHINES

VACUUM CLEANERS

ELECTRIC RANGES

MOTORS

SEWING MACHINES

TOASTERS

WAFFLE IRONS

MANGLES

HEATING PADS

FREEZERS

ELECTRIC FANS

ELECTRIC IRONS

LAMPS

ETC., ETC.



ELECTRONIC KIT TROUBLE DETECTOR
(Checks shorts, wattage, continuity, etc.)
is sent to all students

MAIL COUPON FOR FREE BOOK

Learn this fascinating big money paying profession at home in your spare time. Learn by doing, by working with your hands building, testing, repairing electrical appliances of all kinds. Electrical appliance repairmen are needed everywhere — wherever electricity is used. You need no special previous training or experience. Age is no handicap. CHRISTY has trained over 33,000 men in all parts of the world. Men who today command big wages or own profitable businesses of their own.

PAY LATER FROM EARNINGS WHILE LEARNING

CHRISTY shows you how to make money while still learning, what to charge, how to set up your own shop, how to build power tools from spare parts, etc. It will pay you to write today.

CHRISTY TRADES SCHOOL, Dept. D-2803
4804 N. Kedzie Ave., Chicago 25, Ill.

Send me your FREE book on Electrical Appliance Repairing and special form for "paying later from earnings made while learning."

NAME _____ AGE _____

ADDRESS _____

CITY _____ STATE _____

RUPTURE



RELIEF...OR YOUR MONEY BACK
Original, patented Web, copied but never matched. Users say it's best ever. Relief or no cost to you. Write:

WEB TRUSS CO., Dept. M-3, Hagerstown, Md.

WANTED! Men-Women

between 18 and 55 are wanted to prepare now for 360,000 U. S. Gov't Civil Service job openings in all sections of the country during the next 12 months.*

Some pay as high as \$316.00 a month to start. They offer far more security and better pay than the same jobs in private industry. Many require little or no experience or specialized education.

BUT, in order to get one of these jobs, you must pass a Civil Service test. In some cases as few as one out of five applicants passes!

Franklin Institute helps thousands pass these tests each year. The Institute is the largest and oldest privately owned firm of this kind and is not connected with the Government.

To get full information free of charge on these Gov't jobs fill out and mail the coupon today. The Institute will also show you how you can qualify yourself to pass these tests. Don't delay—act now!

* Estimate based on Official U. S. Government figures

FRANKLIN INSTITUTE, Dept. K-84
Rochester 4, N. Y.

Send me, absolutely FREE (1) list of available positions; (2) free copy of 36-page book, "How to Get a U. S. Government Job"; (3) Sample test questions; (4) Tell me how to qualify for a U. S. Government Job.

Name _____ Age _____

Street _____

City _____ Zone _____ State _____

62

You Can Be a Manufacturer of Gardencrete

Set of 18 Flagstones (below). Sells for \$8.85; Costs to make, \$3.00. Your markup, \$5.85.

Your spare-time manufacture of Gardencrete can lead to a full-time business, with broad sales potentials and generous income possibilities. A small investment buys the Colorglazing machine and a few molds. Add more molds as your business continues to expand.

Gardencrete has wide sales appeal wherever people have pride of lawn and garden. Colors are fused on under air pressure. Stay put for years and years. Choice of 30 colors.

Your mark-up on basic costs is 200%—300%. Products easily made in shed or garage. We supply full instructions. Write for literature and information on costs and selling prices on complete line.

Colorcrete Industries, Inc.
710 Ottawa Ave., Holland, Mich.



**Bird Baths
Jars and Vases
Flower Boxes
Flagstones
Lawn Seats**



NOW! NEW MEMBER OF A FAMOUS FAMILY!
HAWAIIAN WIGGLER #4
 FLASHY DEEP RUNNER HAS SPECIAL ACTION



Toby Shopper, Akron Ohio, used the new No. 4 Hawaiian in the deep holes of the Pigeon River, Ome-mee, Ont., during the heat of the day, to take these beauties. This weighted, flexible, weedless spinner fly casts like a bullet, sinks quickly, runs deep. Large Colorado-type spinner gives more flash while trolling, spins on slow retrieve and while sinking. 1/4-oz. Spinning size or 5/8-oz. Casting size —\$1.15 each.



WEEDLESS—WON'T "HANG UP"

FREE WRITE TODAY FOR YOUR BIG FREE NEW 1954 COLOR CATALOG OF BAITS—FULL OF PICTURES OF CATCHES
FRED ARBOGAST COMPANY, INC.
 2203 WEST NORTH STREET • AKRON 3, OHIO

How to make the most of your home woodworking equipment

POWER TOOL WOODWORKING FOR EVERYONE

By R. J. De CRISTOFORO

Basing his book on famous SHOPSMITH, an expert tells you everything that can be done with multi-purpose and individual tools. Detailed instructions for the table saw, jointer, drill press, lathe, jig-saw, band saw, abrasive machines, shaper; how to adjust and use each tool, and perform every woodworking operation. Suggested work projects and hundreds of time- and money-saving hints. 560 photographs and drawings. \$4.95 at bookstores, or mail coupon below.

FREE 10-DAY TRIAL COUPON

McGRAW-HILL BOOK COMPANY PM-3
 330 West 42nd St., New York 36
 *Please send me "POWER TOOL WOODWORKING FOR EVERYONE" for 10 days' examination on approval. In 10 days I will send \$4.95, plus a few cents delivery, or return the book postpaid. (We pay delivery if you remit with this coupon; same return privilege.)

Name
 Address
 City Zone State

LEFAX POCKET SIZE **\$1.25**
 TECHNICAL DATA BOOKS each

Printed on loose leaf, six hole, 6 3/4"x3 3/4" bond paper, each book contains about 140 pages of technical data, presenting condensed, accurate and essential data for the student, engineer, technical worker and business man.

- | | | |
|--|---|---|
| Architecture
Home Heating
Illumination
Electrician's Data
Builder's Data
Lumber Data
Air Conditioning
General Math.
Math. Tables
Physics
Chemical Tables
Mechanics of Materials
Power Trans. Mach'y.
Thermodynamic
Tables & Charts | Phys. & Thermodyn.
Data
Phys. & Org.
Chemistry
Metals
General
Chemistry
Reinforced Concrete
Building Constr.
Radio
Television & FM
Electricity, AC
Electricity, DC
AC Motors and
Generators | Transformers,
Relays, Meters
Hydraulics
Surveying
Mechanical Drawing
Machine Design
Machinists' Data
Piping Data
Surveying Tables
Trig-Log Tables
Metallurgy
Analytic
Chemistry
Highway
Engineering |
|--|---|---|

Write for FREE catalogs (over 2000 listings). See for yourself how helpful LEFAX can be to you. Send \$1.25 for each book or \$6 for any five books listed above, to

LEFAX DEPT. PM-18 PHILADELPHIA 7, PA.

FUN TO DO . . . PROFITABLE TOO!

LEATHERCRAFT

Textile Painting • Shellcraft
 Beadcraft • Metal Tooling
 Lamp Shade Making
 Other Crafts

Send for
BIG, FREE

Catalog Today!



Complete supplies, everything you need

KIT KRAFT, Dept. 24, 7373 Melrose Ave., Hollywood 46, Calif.

Build your own JET ENGINE!



Order these plans today

1. JET PROPELLED BICYCLE. Assemble your own. Plans and instructions, \$1.00.
2. HOW TO MAKE EXPERIMENTAL JET ENGINES. Seven sheets drawings with information and instructions \$2.95.
3. BOTH OF ABOVE in one order \$3.75. SEND NO MONEY. Order both at once \$3.75 C.O.D. in USA plus c.o.d. postage. Send check or money order and we pay postage. Get other information too. Rush Order.

J. HOUSTON MAUPIN, Dept. 55, Tipp City, Ohio

MONEY in DONUTS

Make new greaseless donuts. Start in kitchen. No smoke. Sell stores. Cash daily. No experience necessary. Free recipes. No obligation. Write! MARTIN RAY CO., 3605 SO. 15th AVENUE, MINNEAPOLIS 7, MINN.



SAMSON FIBER-GLASS BOWS
 THEY DON'T BREAK
 THE WHOLE FAMILY
 CAN USE THE SAME BOW

CATALOG - Five Sets Arrow Materials & HANDBOOK - Illustrated Instructions on Making & Shooting Archery Tackle 75¢

L. E. STEMMER CO., Box 3
 MANORVILLE, L. I., NEW YORK
 Making Bows & Arrows for over 40 years

MAKE CRIME YOUR BUSINESS

ON THE SIDE OF THE LAW!

Help fight crime! . . . Earn steady good pay as a Finger Print Expert or Investigator. I.A.S. trains you—by easy, low-cost home study lessons. Learn this exciting work in spare time. Write for full details now!

OVER 800 POLICE BUREAUS...

Employ I.A.S.-trained men . . . proof of what I.A.S. can do. Write today (state age) for details. No obligation. No salesmen will call.

INSTITUTE OF APPLIED SCIENCE

(A Correspondence School Since 1916)

1920 Sunnyside Ave., Dept. 1353 Chicago 40, Illinois

POPULAR MECHANICS

313 HARD-TO-GET ALL-DIFFERENT STAMPS — 25¢

SPECIAL IMPORTED COLLECTION
incl. BEAUTIFUL GERMAN
MONA LISA

Look at all you get for 25¢! **GERMANY** — beautiful Mona Lisa; **HUNGARY** Diamond Shapes — 3 largest sport stamps ever issued; **SAN MARINO** — multi-colored triangles; **AZERBAIJAN** — 1922 Famine Imperfs cpl.; **BOSNIA** — 1917 Assassination set complete; plus hundreds of other unusual stamps and sets from all over the world — **Andorra, Israel, etc.** Total of 313 stamps — a \$2.50 value — all yours for only 25¢ to introduce our Bargain Approvals. Money back if not delighted. Send 25¢ today. **ASK FOR LOT-F0-13**



PLUS FREE
"Midget Encyclopedia of Stamps"

—includes Stamp Identifier and Dictionary—plus terrific bargains!

ZENITH CO. 81 Willoughby St.
Brooklyn 1, N. Y.

60 POWER TELESCOPE \$3.98

VARIABLE EYEPIECE 20x-40x-60x—BRASS BOUND

NEW! Three telescopes in one. 3 different magnifications. 20 power for ultra-bright images with 40 and 60 power for extra long range. Guaranteed to bring distant objects, people, sports events, ships, moon, stars, etc. 60 times as close. Most powerful for anywhere near the money. 5 sections. Closes to 1 ft. long. Contains 4 ground and polished lenses. Also used as a powerful compound microscope. Directions included. Mass production enables us to offer this instrument at amazing price of \$3.98 complete. Money back guarantee. We pay postage. Get yours now. As a Microscope

CRITERION CO. 331 CHURCH ST.
DEPT. PMB 21 HARTFORD 3, CONN.

FREE BERRY'S NEW POULTRY BOOK

Gorgeously illustrated, describing **DAY-OLD** and **4-WEEK CHICKS**, 80 varieties, sexed or unsexed. **AMERICA'S FINEST**; also Ducks, Geese, Guinea. **ORIGINAL BERRY'S FARM**, for over 80 years. Beautiful book and **LOW PRICE LIST FREE**, stamps appreciated. **BERRY'S POULTRY FARM**, Box 23, Clarinda, Iowa

"How to Make Money with Simple Cartoons"



A book everyone who likes to draw should have. It is free; no obligation. Simply address **FREE BOOK**

CARTOONISTS' EXCHANGE
Dept. 93A Pleasant Hill, Ohio

Operation "EASY STREET"

Take the Red Comet road to Big Profits

Earn up to \$10,000 or more per year!

Nothing to invest! Full or part time!

Make year-round profits selling famous Red Comet automatic fire extinguishers. Easy to sell! Every home, farm, business a prospect. Advertised Post, Collier's, Country Gentleman. Priced to sell quickly—a sales "natural"!

FREE SALES KIT

Demonstrator units, sales literature, etc., furnished you **FREE**. Handsome leather-type kit. Tried and proved over 21 years. It will make you an independent business man. Someone in your community will be appointed soon. Write for details today!

RED COMET, Inc.

Dept. 375-J, R.C. Bldg., Littleton, Colo.



U.S. Pat. D 153853 D 153854



BECOME AN Electrical Engineer



- Major in Electronics or Power
- Earn B. S. Degree in 36 months

Over 50% of the nation's industrial leaders began their careers with engineering training. Today, the demand for young, trained Electrical Engineers and Technicians is constantly expanding. Eight separate programs give you a wide range of career opportunities.

Plan Your Career From these Courses in Electrical Technology

ENGINEERING COURSES

Electrical Engineering — Bachelor of Science Degree
Save a valuable year through optional year 'round study.

Electronics major 36 months

Power major 36 months

TECHNICIAN COURSES

Electro Technician 12 months

Electronics Technician 12 months

Radio Technician 12 months

Radio and Television Technician 18 months

SERVICE COURSES

Electrical Service 6 months

Radio and Television Service 12 months

MECHANICAL TECHNOLOGY COURSES

— Also available, Service Technician courses 6 to 18 months — Heating, Refrigeration, Welding, Air Conditioning and Mechanical — Mechanical Engineering with a major in Design, Metal Fabrication or Plant Engineering.

Also, general 3-month preparatory course.

Terms open April, July, October, January

Approved for veterans. Prior Military, Practical or Academic training evaluated for advanced credit. Faculty of specialists. 50,000 former students. Annual enrollment from 48 states and 23 overseas countries. 51st year. Non-profit.

Send handy coupon for complete information. (Residence Courses Only)

MILWAUKEE SCHOOL OF ENGINEERING

MILWAUKEE SCHOOL OF ENGINEERING
Dept. PM-354, 1025 N. Milwaukee
Milwaukee 1, Wisconsin

Send free pictorial "Your Career Booklet"



I am interested in name of course

Name Age

Address

City Zone State

If veteran, indicate date of discharge

"NOW I'M MY OWN BOSS at Double My Former Salary"



Paul M. De Vita, Former Low Paid Auto Mechanic
Steps-Up Earnings to Over \$100 a Week

As A CUSTOM UPHOLSTERER

"I can hardly believe how quickly I've gotten ahead in this interesting and profitable trade. I was an auto mechanic making about \$55 a week. Now I operate my own shop and make more than \$100 a week doing mostly contract work. My window display brings in a lot of extra business besides. UTS training sure has been valuable."

WHAT DO YOU WANT? Your Own Business—A Steady Job—Substantial Sparetime Earnings—A Better Future?—They're all waiting for You in the Big-Opportunity Field of Custom Furniture Upholstery.

AT HOME in spare time, you can do what Paul M. De Vita and hundreds of UTS graduates have done—easily, quickly! Trained upholsterers are scarce. You can earn as you learn to make good money all year 'round at home, in your own shop, or in a well-paid job. The practical N. Y. State-approved UTS course teaches you professional custom furniture upholstery, reupholstery, slipcovers, furniture finishing, repairs, PLUS 3 BIG EXTRAS—window cornice, cushion and drapery making. You get—FREE ALL tools, complete frames, fabrics and materials you use to make beautiful upholstered furniture and slip covers worth over \$225 that are yours to keep or sell!

YOU MAKE

SLIPPER CHAIR

CLUB CHAIR

OTTOMAN

PLUS SLIP COVERS

Yours to keep or sell

Our FREE book, "Your New Way to A Successful Career" tells you all about this fascinating, big pay, big opportunity trade. **WRITE TODAY!** Training in N. Y. School also available. **UPHOLSTERY TRADES SCHOOL, Dept. CC-305, 721 B'way, N. Y. 3.**

SEND FOR BIG FREE BOOK

UPHOLSTERY TRADES SCHOOL, Dept. CC-305
721 Broadway, New York 3, N. Y.

Send me FREE book on:

Home Study N. Y. School Training

Name _____

Address _____

City _____ Zone _____ State _____

Check here if Korean Veteran

Steve Wrobel

ACT NOW!

GET THE COMPLETE FACTS ABOUT THIS AMAZING NEW BODY-BUILDING COURSE BY THE MOST EMINENTLY QUALIFIED MAN IN CANADA.

MUSCLES MAKE THE MAN

LET ME HELP YOU AS I'VE HELPED HUNDREDS OF OTHERS.

You too can have a beautifully moulded and graceful body. WITH MY NEW SECRET SYSTEM of muscle co-ordination and body building your whole body will surge with physical vigor and body tone. Profit by my amazing course on physical development and physical attractiveness, gain the admiration of women and the respect of men. In a few short weeks you can take care of yourself in any crowd; it's like getting personal tuition at home for less than the cost of one lesson in class.

MAIL THIS COUPON TODAY

STEVE SAMSON ATHLETIC STUDIO, Box 10, Oshawa, Ont., Canada

Send me C.O.D. your course on "Muscles Make The Man," I will pay postman \$1.98 on delivery plus postage.

Name _____

Address _____

City _____ Prov. _____

If you enclose \$2.00 with order, we prepay all delivery charges. Amt. Enclosed \$ _____. Sorry no C.O.D. to U.S.A.

OVER 700% PROFIT!

WITH THE **PDQ CHAMPION PHOTOMASTER**

Makes finished pictures in 2 minutes.

Takes and finishes 30 to 40 everlasting, black and white or sepia photos an hour. No dark room. Guaranteed not to fade. Photos taken on "SUPER-SPEED" direct positive paper. Picture size 2 1/2 x 3 1/2 in. Complete, easy-to-operate portable photo studio. Size 4 1/2 x 5 1/2 in. Wt. 8 lbs. **700% PROFIT.** Write quick, get details about the great **PDQ CHAMPION PHOTOMASTER.**

P D Q CAMERA CO.
1161 N. CLEVELAND AVE. Dept. PM-354 CHICAGO 10, ILL.

KEEP OFF

129 NEW FULL SIZE \$1.00 PATTERNS

EASY-TO-USE PATTERNS (just trace on wood, cut out, sand) on 129 Unusual Novelties, Gifts, Lawn Figures up to 22 in., Action (merry-go-round) Windmills, Toys, Useful Gadgets, etc. Artist drawn. Money Back Guarantee. Clip this ad and mail with \$1. bill TODAY.

CRAFTPLANS, Dept. A-238, 1321 S. Michigan, Chicago 5

MAKE MORE MONEY!

Dealers or Representatives Needed for nationally advertised line of Spark Plugs — Oil Filters — Auto Specialties — Liberal Proposition — Full or Part Time — Experience Not Necessary — Write Today

ENGINE PRODUCTS MFG. CO.
5801 E. Beverly Blvd., Dept. 140, Los Angeles 22, Calif.

Catalog of 3000 Novelties 10c

Send 10c for amazing catalog of novelties, live animals, scientific supplies, hobbies, funmakers, planes & boats, looms, magic tricks, joke articles, unusual seeds, gad- get time-savers, cameras, optical goods, projectors, movies, lucky jewelry, religious novelties, disguises, musical instruments, stamps, coins, puzzles, fortune tellers, radios, auto & bike accessories, telescopes, magnifiers, compasses, banks, smokers' gadgets, artists' supplies, printing sets, eye gines, motors, shockers, knives, billfolds, guns, rifles, sports, books, games, plants, etc. Send name, address & 10c to:

JOHNSON SMITH & CO., Dept. 787, Detroit 7, Michigan

LEARN Modern Appliance and Electrical Servicing

Revolutionary New Method shows you how—at home—in YOUR SPARE TIME! We send you complete Home Training Kits and Latest Engineered Test Equipment. You can actually earn BIG MONEY WHILE LEARNING! Many men are making \$2.50—\$3.00 and more PER HOUR! RUSH name and address for big FREE book and full details—WRITE TODAY!

**ADVANCE TRADES INSTITUTE, Dept. 143
5944 NO. NEWARK AVE. CHICAGO 31, ILL.**

AVIATION

Pays You More With a Schooling at PARKS

NOW! A&E MECHANIC LICENSE COURSE

45-week course, all phases aircraft & engines.
Enrollment Dates: Apr. 15-16, 1954

FLIGHT COURSES—Private, Commercial, Instrument, Instructor, Multi-Engine.

DEGREE COURSES—B.S. degree in 3 yrs. from Saint Louis University — Aero. Engineering, Maint. Engineering, Aero. Administration.

All Parks Schooling Approved for Veterans
Write Today.

PARKS COLLEGE ARNOLD HALL
EAST ST. LOUIS, ILL.

EZO

the soft pink
easy to
use
dental
cushion
helps
**FALSE
TEETH**
fit
comfortably



Helps you to eat the foods you enjoy. Scientifically designed in a modern laboratory to help ease pain of sore gums from ill-fitting plates.

- Helps plate fit snugger
 - Helps prevent embarrassing clicking
 - Helps you to enjoy living
- Not a messy paste or powder—just press on plate for pleasant relief from ill-fitting dentures!

Order Direct From Laboratory
Money back if you aren't delighted!
send \$1.25 for 20 EZO Lower
send \$1.25 for 16 EZO Uppers
or send \$2.50 for both

EZO PRODUCTS CO.
Dept. 587-B, Box 9306, Phila. 39, Pa.

MAKE MONEY IN LANDSCAPING



Thorough training by Internationally known Landscape Architect to start your own business, improve your home or advance in this well paid field. Many opportunities.

Send for FREE BOOK
NATIONAL LANDSCAPE INSTITUTE
Dept. P-3, 310 S. Robertson Blvd., Los Angeles 48

LEARN WATCH REPAIRING

AT HOME Modern, original instruction. Prepare for a position or start in business after completing our course. Write Today!
WISCONSIN SCHOOL OF WATCH REPAIRING
759 N. Milwaukee St. Dept. M Milwaukee 2, Wis.

ARRO-PING



—the Original Arrow Sling-Shot has accuracy and power for small game or target with swift ping of an arrow. Sturdy, smoothly-made wood stock, guided-flight barrel, slender metal-tipped 12-inch arrows. Powerful rubber propulsion sends arrow 300 feet. Try skill in a new hunting thrill.

ARRO-PING CO.
Box 25H West End Station,
Colorado Springs, Colo.

Postpaid,
with five
Arrows, \$1.25
Or Arrows alone
20 for \$1.25

Say You Saw It in Popular Mechanics



personal
**POCKET
PRINTER**

Prints Up To 3 Lines

ONLY
\$1.00
Postpaid

for Clothes, Stationery, Checks, etc.
3/4" x 2 3/4" plastic case fits pocket or purse. Has automatic inker. Limit 25 letters per line. Order now for each one in your family. Prompt delivery.

Satisfaction guaranteed or money refunded.
GIFTS & GREETINGS, Rockland 63, Mass.

AMAZING OFFER

FREE!

100 FOREIGN STAMPS

from all corners of the world
GUARANTEED WORTH \$1.00
AT STANDARD CATALOG PRICES
AND SOUVENIR OF
WORLD'S RAREST STAMP

AND VALUABLE STAMP COLLECTOR'S GUIDE

RUSH coupon at once. We'll send you by return mail this gigantic offer — 100 stamps from Europe, Asia, Africa, South America, Near East and Far East. **GUARANTEED WORTH \$1.00** at Standard Catalog prices. No telling what you'll find. **NO COST TO YOU!**

These valuable stamps are all genuine — unsorted and unpicked. We just scoop them out of sacks we receive from foreign missionaries, banks, etc. and rush them into packets for you.

There are beautiful big pictorials, commemoratives — stamps from great empires and tiny republics. You'll find wild animals, far-off places and famous people on these wonderful stamps — even some from "iron-curtain" countries. Since no one has examined them, you may even find real hidden treasures, worth **REAL MONEY.**

Yes, we'll rush this wonderful offer that gives you 100 stamps from **EVERYWHERE**, plus a beautiful souvenir of **World's Rarest Stamp** in color, **PLUS** our illustrated booklet "Stamp Collector's Guide" — **FREE**, if you act **AT ONCE!** Other valuable offers also included for your **FREE** inspection! If coupon is clipped, send to:

GARCELON STAMP CO.
Dept. 3 PM, Calais, Maine

PLUS

SOUVENIR OF WORLD'S RAREST STAMP

Here is a treat indeed — and exclusive with us. Only here can you get this handsome, new folder with the beautiful reproduction in color and the fascinating story about the British Guiana stamp that sold for \$1.50 in 1873 and is worth \$50,000 today! You'll be the envy of all who see it! Display it in your album or frame it for your room!

GET ALL 3 FREE!

GARCELON STAMP CO., Dept. 3 PM, Calais, Maine
Rush me **FREE** 100 FOREIGN Stamps, Rarest Stamp Souvenir and **STAMP COLLECTOR'S GUIDE**. PLEASE PRINT

NAME

ADDRESS

CITY.....ZONE.....STATE.....



Garlinghouse HOME PLANS

America's Pioneer Home Plan Service **for Better Living**

5 LATEST PLAN BOOKS—1 TO 4 BEDROOM SIZES

- **"RANCH AND SUBURBAN"**
128 ranch plans most practical for town and country.....50c
- **"DELUXE SMALL HOMES"**
Our largest selection—155 modern, time-tested designs...\$1.00
- **"HOMES IN BRICK"**
Many of these 115 tested designs of medium and large homes are in color.....\$1.00
- **"YOUR NEW HOME PLANS"**
2nd Edition. 64 pages (16 in color) of excellent plans for modern families.....50c
- **"BLUE RIBBON HOMES"**
2nd Edition. 63 pages of homes proved popular by actual sales. Many in color.....50c

Select your new home from the hundreds of photographs and colored drawings in these five books. All sizes and styles are shown along with accurate description and floor plan of each. Complete working plans, specifications, lumber and mill lists are available for every design at low cost which is listed with each design. The moderate price of these plan sets is your best investment when building, since you know in advance what you are getting, thus avoiding misunderstandings. Complete plan sets when ordered will be sent by return mail (24-hr. service), on a money-back guarantee if unused plans are returned in five days.

All 5 above books for \$3.00, Postpaid—
Our Complete Home Plan Library — 18 books and over
1,250 Home Designs — Only \$8.00, a \$2.50 Saving.

ORDER YOUR BOOKS TODAY
All Books POSTPAID. No C.O.D.'s Please

L. F. GARLINGHOUSE CO., INC., Box PM-21 TOPEKA, KANSAS



**I HELPED T.E.H. MAKE \$14 A DAY
WHILE STILL LEARNING!**

T. E. H.—West Virginia, "By the time I finished half your course, I was making \$14.00 per day. I have made enough on the side to more than pay for the course."

H. T. ARMSTRONG

Learn

ELECTRIC APPLIANCE REPAIR & SERVICE

WE TEACH:
How to Repair
Washing Machines
Vacuum Cleaners
Electric Ranges
Lamps, Motors,
Irons, etc.,
REFRIGERATION
and
House Wiring
At Home
In Your
Spare Time!

For a man handy with tools, and happiest when working with his hands, OPPORTUNITY is Wide Open Today in this great and growing field. Everyone is a customer for the man trained to service electric appliances.

Open Your Own Shop

Our practical Floor Course teaches you this business from A to Z—preparing you to take a well paid job or open your own shop. You can actually start in your basement or garage with the tools we send you... before finishing.

We
include An
ELECTRICAL APPLIANCE TESTER
A Big Kit of Tools
at NO EXTRA COST

MAIL THIS COUPON for FREE BOOK

H. T. ARMSTRONG
PACIFIC TRAINING SCHOOLS Dept. P-543
7217 S. Broadway, Los Angeles 3, Calif.

Dear Sirs: Please send me, without obligation, your free booklet and complete details.

Name _____
Address _____
City _____ Zone _____ State _____

NEW! First Time Ever

APE MAN MASK

It's TERRIFYING!
Scares people out
of their wits!



Even more gruesome than Frankenstein... this hideous APE Mask. Realistic colors with life-like hair; made of sanitary rubber; fits comfortably on your head, easily into your pocket. You'll be a hit at every party, at work, club, everywhere! Don't show it to anyone with a bad heart. Send today! Special price!

FREE—Book of Magic and Joke items with each order!
\$2.98
Ppd. No C.O.D.'s

the magic center Also—Frankenstein Mask, \$1.98
Dept. PM-2, 741 Eighth Avenue, New York 19, N. Y.



30 DAY FREE TRIAL

High Power **BINOCULARS**

Finest Precision Optics
Featherlight

Money Back Guarantee

Easy Pay Plan

Leather Case Incl'd

Free! Catalog & Book

"How to Select Binoculars"

Dealer Inquiries Invited

Bushnell Bldg., Dept. M83

Pasadena 1, Calif.

BRAND NEW 33 MODELS \$14.95 up

BUSHNELL Binoculars

CARTOONING!



For fun and profit! Made easy with amazing new method. Now anyone, young or old, can learn to draw professional looking cartoons with few hours practice! No talent or skill necessary. Over 475 illustrations. Complete outfit and instructions.....Only \$2.00

CARTOON-CRAFT Dept. IM

5864 Hollywood Blvd., Hollywood 28, Calif.



UP TO 6 MILES MORE PER GALLON

Reported by Hundreds Using

MIRACLE ACTION TUR-B-LIZER

Carburetor specialists say Tur-B-lizer is best patented improvement they have seen. Tested in millions of miles of driving in cars, trucks and tractors. Easily installed. Send \$3.00 for six cylinder type, \$4.50 for eight cylinder type. Try Tur-B-lizer for 30 days. If you are not enthusiastically satisfied as claimed by hundreds of users, your money will be promptly refunded.

Mechanics-Salesmen: Make big money selling and installing. Write for full facts.

UNIVERSAL TUR-B-LIZER CO.

621 E. STATE ST. MILWAUKEE 2, WISC.

Say You Saw It in Popular Mechanics

EARN \$25 TO \$75 A WEEK IN SPARE TIME ... No Selling To Do!



With Guaranteed JETMATIC Venetian Blind Laundry

No risk, because you start your own business part time in your basement or garage. In a short time, when your profits exceed your job salary, you will make it your FULL-TIME business, as hundreds of others have done. Tremendous untapped demand from homes, offices, factories, for this low-cost service. JETMATIC, made by world's largest manufacturer of professional Venetian blind laundries, guarantees perfect results without taking blinds apart, without hand rubbing. WRITE TODAY for complete details and experiences of hundreds of men of all ages who are making more money with the JETMATIC.

No Experience Necessary

Even a woman can operate it! We furnish complete details for operating and for getting business quickly, effortlessly.

L. C. ROBINSON MANUFACTURING CO.

522 North Rural St. DEPT. M7 Indianapolis 1, Ind.

Now YOU can PICK your JOB and BIG PAY Future in Allied's Nation-Wide Industrial Co-op Plan

INDUSTRY CRITICALLY NEEDS ALLIED TRAINED MEN TO FILL IMPORTANT JOBS

EARN YOUR BACHELOR'S DEGREE IN 31 MONTHS

- . TOOL ENGINEER**
- . TOOL & DIE DESIGNER**
- . MACHINE DESIGNER**
- . MECHANICAL ENGINEER**
- . DRAFTSMAN**
- . MASTER MACHINIST**
- . TOOL & DIE MAKER**

Shortages of Draftsmen, Designers, Tool Engineers, Machinists, Tool and Die makers are so widespread that you can pick a key job and look forward to rapid promotions, better pay, job security, success and achievement. Industry is expanding so rapidly that there are more good paying jobs than there are trained men to fill them.

Industrial Co-op program is integrated so that you can either study at home or at the Allied Institute's fully equipped shops and laboratories. You may enroll in short courses or study progressively for a Degree of Bachelor of Tool Engineering or Bachelor of Mechanical Engineering.

Allied is approved by Industry, the American Society of Tool Engineers, Department of Registration and Education, Department of Public Instruction, State of Illinois, Department of Justice for foreign Students, and the Veterans Administration. Accredited by Central Schools Assoc.

ALLIED SCHOOL of MECHANICAL TRADES

Allied Institute of Technology

1338-42 S. Michigan Ave. Dept. PM-3 Chicago 5, Illinois

Gentlemen:

I want to get into important Industrial Trades and Professions. Send me without obligation your FREE BOOKS explaining Allied's Courses of Instruction and information on Nation-Wide Industrial Co-op Plan.

I am interested in Resident Training Home Study

I am eligible for the G. I. Bill I am not eligible

Name _____

Address _____

City _____

State _____

send for **FREE BOOKS**

ALLIED SCHOOL of Mechanical Trades
1338-42 South Michigan Ave
Chicago 5, Illinois

PORTABLE GARAGE
\$6.75 (Former Price \$10.00)
USE IT ANYWHERE

- Folds compactly • Keeps rain, snow, dust, salt air, sun away
- Protects your car's finish • Durable
- Constructed of vinyl plastic • Spring-tension elasticized bottom, holds securely • Fits all makes
- Direct from MFG. • Enclose payment of \$6.75 plus \$0.35 postage or send C.O.D. 10-Day Money Back Guarantee.

EXTRA HEAVY GARAGE \$8.95 (Formerly \$12.00)

MARDO SALES CORP.
480 LEXINGTON AVE., DEPT. G-012, NEW YORK 17, N. Y.



GET "New Car" POWER!

- Stop Burning Oil!
- Restore Compression!

\$3.95 post-paid

A small amount of Fisher's Compression SEAL in each cylinder bore gives you the economies of smooth, powerful "new car" performance and reduced oil consumption. Old, tired engines may not need expensive overhauling. Only takes minutes to apply—yet gives you 10,000 more miles of low-cost driving pleasure.

SATISFACTION GUARANTEED!
Full purchase price refunded immediately, if not completely satisfied. No solvent baths necessary. Order today! Information. Dealers inquire.

FISHER'S 4756 S. Central, Dept. PM-3
Los Angeles 11, Calif.



500 TRICKS

MAGIC TRICKS
IT'S FUN TO DO MAGIC

Be popular! Amaze—mystify—entertain! For 30 years Douglas has satisfied customers all over the world. Now, you can enjoy this fascinating hobby. Only 10c brings our Catalog 500 Tricks, containing brand new tricks for pocket, parlor, stage. Join in the fun—send 10c today!

Douglas Magicland, Dept. A, Dallas, Texas



SAY YOU SAW IT IN POPULAR MECHANICS

EARN BIG MONEY!

GROW "LIVING" MIDGET TREES!

AT HOME — SPARE TIME — NO EXPERIENCE NEEDED!

It's new! Amazing! At last, the secret of growing miniature (MING) trees can be yours. FULL GROWN, dwarf trees—only a few inches high. Beautiful miniature fir, orange, oak, Chinese elm, peach, pine, cypress—any kind! All BLOOM and even BEAR FRUIT. All perfect healthy specimens—but miniature in size! Make costly home decorations and expensive centerpieces. (SOLD FOR OVER \$1,500 EACH.) Big demand. Costs only pennies—takes only minutes per week. IT'S EASY! Fun! A new fascinating hobby—a new fabulous \$\$\$ business. Send for free secret plan details and real seed.

HELP US FILL HUGE DEMAND
These trees are being demanded by STORES · CLUBS · HOTELS · FLORISTS · HOUSEWIVES · INTERIOR DECORATORS · COLLECTORS · HOBBYISTS—Big Money Opportunity for you.

MAIL TODAY FOR FREE SEED AND PLAN!

NATIONAL NURSERY GARDENS, Dept. M-3
8463 South Van Ness, Inglewood 4, California
Rush me FREE PLAN and SEED IMMEDIATELY!

Name _____
Address _____ Zone _____
City _____ State _____

HOW TO LEARN GROWING SECRETS
\$ BOTH SEED FREE



TURN SPARE HOURS INTO CASH



Few Hours Evenings and Week Ends Can Pay up to

\$16.50

A DAY AND MORE!

Every Car Owner Wants Sensational "Wipe-to-Clean" Plastic AUTO SEAT COVERS

Here's big money! Just show car owners America's most sensational Auto Seat Cover values. Newest materials; exciting variety of colors and styles. Superb tailoring means perfect fit for every model, old or new. Amazing low prices . . . bring you big profit orders. New line includes popular "wipe-to-clean" plastics (just a few strokes with a damp rag cleans like new) . . . BAMBOO, PIESTA, PLAIDS, many more. Get YOUR OWN \$50.00 SET OF SEAT COVERS AS BONUS!

Big FREE OUTFIT — Send No Money

Rush name and address on coupon below. Send no money. We'll rush complete new FREE SALES OUTFIT including many actual samples. Start earning from first day. No experience needed. Just make a few pleasant calls a day on car owners in your town. Hurry . . . RUSH COUPON TODAY for FREE OUTFIT.

KEY PRODUCTS, Dept. 443, 800 N. Clark St., Chicago 10

KEY PRODUCTS, Dept. 443, 800 N. Clark St., Chicago 10, Ill. Rush MONEY MAKING auto seat cover sales outfit, including actual samples—all FREE.

Name _____
Address _____
Town _____ State _____

DIESEL MECHANICS NEEDED

BIG PAY — GOOD FUTURE

Virtually all heavy power equipment is rapidly going DIESEL, creating big paying, steady jobs—through good times or bad—for properly trained men.

Back during the DEPRESSION . . . there was a big demand for Bailey Trained Diesel mechanics.

We can QUICKLY TRAIN YOU to enter this big pay field . . . no previous experience or special education necessary!

With our method of training you don't spend years pouring over books, figures, charts or graphs—you learn by repairing and operating big Diesel engines, under the guidance of experienced and friendly instructors.

This method of training gives you the experience and confidence that enables you to move right into the BIG PAY JOBS without spending years-as-a mechanic's helper. We help you find part-time jobs while in school—full-time jobs after graduation. Mail coupon for complete information.

BAILEY Technical SCHOOLS

Veteran Approved

1626 S. Grand St. Louis 4, Mo.

NAME.....AGE.....
STREET.....
TOWN.....ZONE.....STATE.....

more jobs than graduates

ENGINEERS
Enging opportunity! If you are interested work in these 11 pay you to write Box D 1 including a complete history of the college and education.

Demand for our engineering graduates exceeds supply. Effective placement! Study in this world-famed college . . . established 1884. New term starts quarterly. Approved for Korean Vets.

Bach. Sc. degree in 27 months

Bachelor of Science in Mechanical, Civil, Electrical, Chemical, Aeronautical, Radio (Television), Administrative Engineering; Business Administration and Accounting. Also 36-weeks certificate courses in Surveying, Drafting, Secretarial Science. Intensive program; technical fundamentals accepted.

Small classes; personalized instruction. For earnest, mature students whose time and budget require accelerated courses and modest costs. Preparatory courses.

Beautiful campus in friendly college town. Well-equipped, new and modernized buildings and labs. Enter March, June, Sept., Jan. Write Jean McCarthy, Director Admissions, for Catalog and View Book.



TRI-STATE COLLEGE

434 College Avenue Angola, Indiana

PUMP WATER FAST!

DRAIN WASH TUBS, CELLARS, CISTERNS IRRIGATE—FILL TANKS—DRAW WELL WATER



Pumps 2800 GPH, 420 GPH at 75' High or 1600 GPH from 25' well. Sturdy, Rustproof Alloy Metal. Six Blade Impeller. Uses any 1/8 to 1/2 H.P. Motor. Will not leak or clog. Fits any garden hose. Immediate Money Back Guarantee. Send Check, M.O., or C.O.D. **\$8.95** U.S.

MOORE MANUFACTURING CO. SWEDSBORO 1 NEW JERSEY

RUPTURE!

An amazing Air-Cushion Invention allows body freedom at work or play. Light, neat, cool, sanitary. Durable, cheap. Day and night protection helps Nature support weakened muscles gently but surely. No risk. Sent on Trial! Write NOW for free Booklet and Proof of Results. All correspondence confidential.



Brooks Company, 373-C State St., Marshall, Mich.



You're Right!

NOBODY LIKES TO ADD & SUBTRACT FRACTIONS

Get a Fractionator

\$1.00 POSTPAID U.S.A.

Direct reading. Answers in Fractions & Decimal Equivalents. 100% Accurate. Handles all Engineering Fractions.

Chas. E. Wells • Box 25-A • Montrose, Calif.

SAY YOU SAW IT IN POPULAR MECHANICS

NEW! POLARVISION SAFETY LIGHT



A revolutionary new light discovery recently released for civilian use.

STOP HEADLIGHT GLARE

FOR SAFETY AND COMFORTABLE DRIVING The Amazing "Krypton Glass Lens" is an integral part of the Polarvision Light. It produces a Black Light barely visible to the eye which counteracts oncoming headlights, street lights, etc. without interfering with your visibility. Easy to install above windshield—beautiful accessory. Light encased in high grade chrome holder. Works off car's central lighting circuit. Limited Supply. Complete \$6.95. Send cash, check, or money order. **Guaranteed**

Electronic Developments, Dept. BP-3 10418 Venice Blvd., Culver City, Calif.



BRAND NEW!

Firestone TIRES

SAVE UP TO 50%

SEND FOR FREE CATALOG

BRAND NEW—FIRST QUALITY FIRESTONE PASSENGER TIRES

All Tires Carry Famous Firestone Unconditional Guarantee		BLACK WALL TIRES 4 PLY FULL PRICE	
700x15 6 ply	29.78	640 x 15	11.82
600x16 6 ply	17.78	650 x 15	14.29
680x16 6 ply	21.58	670 x 15	12.50
700x17 6 ply	30.78	710 x 15	13.88
600x20 6 ply	24.31	760 x 15	15.12
650x20 8 ply	31.47	800 x 15	11.12
700x20 8 ply	35.45	820 x 15	14.29
700x20 10 ply	42.48	WHITEWALL TIRES BRAND NEW (Factory Blemish) First Line 4 ply Pass. SPECIAL: SPECIAL:	
750x20 8 ply	45.15	670 x 15	15.24
		710 x 15	16.83
		760 x 15	18.41
		800 x 15	20.23
		820 x 15	21.04
		SUPER SPECIAL!	
		670 x 15	11.91

(Order by Mail—Send check or M.O.) • (all prices f.o.b. plant)
Farmers—Full line of tractor tires—Write for Prices

S & S TIRE CO.

1400 HADDON AVE. CAMDEN 3, N. J.

The WONDERS of LIQUID PLASTICS

MANUFACTURE WITHOUT TOOLS OR MACHINERY! WE PAY YOU \$5.00 AN HOUR!

No previous experience or special ability required! NO TOOLS OR MACHINERY required... the entire process is about as easy as pouring water out of a glass! The WONDERS OF LIQUID PLASTICS make all this possible! Many of the products made with our liquid plastics are so beautiful and attractive that we have created an unusual demand for this type of merchandise! That's why we will pay you \$5.00 an hour (materials extra) to make the items shown here and in our catalog for us!

UNLIMITED POSSIBILITIES

Work with LIQUID IVORY, LIQUID GLASS, LIQUID MARBLE, LIQUID EBONY, LIQUID PORCELAIN, LIQUID WOOD, LIQUID GEMSTONE and many other LIQUID PLASTICS and in a matter of minutes turn them into an endless and valuable procession of beautiful imbedded jewelry, novelties, ornaments, statues, bookends, lamps, pensets, lighters, ashtrays, keychains, figurines, curios, SOUVENIRS, art and gift products, fishing lures, BOATS, GADGETS galore, exquisite GEMS! Make gears, tools, dies, forms, handles, dials, knobs, MACHINE PARTS, models of inventions, pistol grips... the list is endless! The only LIMITATION is your IMAGINATION! Liquid Plastics are the blessing of every creative and ambitious person... with these materials ANYONE can create and manufacture by the THOUSANDS and at a tiny fraction of what it would cost by any other method! Just send 25c and we will send you our book, "HOW TO MANUFACTURE WITHOUT TOOLS OR MACHINERY," included with our big 64 page catalog describing all the materials mentioned above; also details of our \$5.00-an-hour offer! Do it today... we want you to share in these wonderful opportunities as soon as possible!

PLASTICAST CO., (Dept. C)
P.O. Box 6737 (Write to P.O. Box 987 Chicago 80, Ill. either address) Palo Alto, Calif.



PLASTIC LAMINATING

This remarkable Plastic Laminating Machine will earn \$15.00 an hour right in your kitchen! Big profits laminating Business, Social Security, Identification, Credit CARDS of all kinds, photos, passes, clippings, etc. Price complete (illustrated) \$25.00 plus postage. Others higher. Literature free.

PLASTICAST CO.
(Address in ad above)



LAW

Men and women **STUDY AT HOME** for Business Success and **LARGER PERSONAL EARNINGS**, 44 years expert instruction—over 114,000 students enrolled. LL.B. Degree awarded. All text material furnished. Easy payment plan. Send for **FREE BOOK**—"Law and Executive Guidance"—NOW!

AMERICAN EXTENSION SCHOOL OF LAW

Dept. PM-72, 664 N. Michigan Ave., Chicago 11, Illinois

EASY TO LEARN CODE

Learn to increase speed with an Instructograph—the Radio-Teletype Code Teacher that takes the place of an operator-instructor and enables anyone to master code without further assistance. Available tapes from beginners alphabet to typical messages on all subjects. Speed range 3 to 40 WPM. Always ready—no QRM. Thousands have "acquired the code" with the Instructograph System. Write today for convenient rental and purchase plans.

INSTRUCTOGRAPH COMPANY
4701-V Sheridan Road, Chicago 40, Illinois



Say You Saw It in Popular Mechanics

LEARN MEAT CUTTING AT NATIONAL

Pay After Graduation



The steady dependable trade of Meat Cutting taught easily in 8 short weeks. **YOU LEARN BY DOING** under actual meat market conditions in big modern school at Toledo.

For beginners or men with experience. Get a profitable store of your own. Remember, **PEOPLE MUST EAT!** Big pay jobs. Free employment help. Thousands of successful graduates.

Buying, cutting, percentage, pricing, advertising, selling, etc. A complete retail meat education. National School established over 30 years. Get National training **NOW**. Pay your tuition in easy weekly payments

after you graduate. Send coupon for **FREE 52 page school catalog** — TODAY. G.I. approved.

National School of Meat Cutting, Inc., Dept. 50-C, Toledo 4, Ohio

Send me your **FREE** school catalog on National Training at Toledo in Meat Cutting, Meat Merchandising and Self Service Meats. No obligation. No salesman will call.

Name _____ Age _____

Address _____

City _____ State _____

Approved for training Korean Veterans

SUCCESS PUBLISHERS PRESENTS

YOUR SUCCESS

1954

Here it is! "YOUR SUCCESS—1954" is the course that brings you the answers to the problems that have been troubling you. It is a complete approach to success, offering information on: the best spots for money-making today, valuable facts about jobs that pay the most, important investment advice, the success formulas of famous people, the "World Opportunity Chart" and a vast amount of other data.

This is a practical course—not just a course in public speaking, personality building, or selling. This tells you specific facts about making money in atomic development, radio and television, oil wealth, real estate, stocks, the writing field, public relations, and important new areas.

If you want to go into business for yourself, want a raise, or want extra income, you should have the course now. You will be astounded by the amount of useful information in this low-priced course. The course has one purpose—to tell you how to gain financial security. For the sake of your future send for free information now. No obligation. No salesman will call.

SUCCESS PUBLISHERS, INC. Box 19
710 S. Federal St., Chicago 5, Illinois

.22 RIFLE BARGAIN CARBINE STYLE

34 inches long
Weighs 4 lbs.



\$14.95

EXCLUSIVE WITH UNITED! GERMAN Feather-weight precision made rifle. Simplified rugged construction. One screw take down assembly. Has automatic ejector with self-adjusting sporting rear sight, blade front sight. Barrel has SIX lands! Blued thru-out. HIGHLY POLISHED BOLT ACTION. Amazing accuracy at 100 yard range! Replacement parts easily secured if ever needed.

SHOOTS AMERICAN LONG, SHORTS, LONG RIFLE (regular & high powered). 10 DAY NO RISK TRIAL. If not satisfied return for \$14.95 refund. Transportation collect. C.O.D.'s require \$2.00 deposit. Mail Orders Only. None sold to minors. STATE AGE. UNITED ARMS CO., 9043 S. Western, Dept. CH08-465, Chicago 20.

Say You Saw It in
POPULAR MECHANICS

BUILD your own TV Set

YES, actually build a valuable TV Set right at home. At the same time learn all about installing, repairing, servicing—and get ready for a Big-Pay Job in America's fastest-growing, most exciting industry. The CTI TV Train-at-Home Plan is preparing hundreds for bigger pay TODAY—and a brighter, Future TOMORROW. No experience needed. We supply easy-to-understand instructions—made clear with hundreds of charts, diagrams, photos—plus TWENTY KITS of Parts, Professional Equipment and Tools. Get a TV Set to ENJOY. Get set to ENJOY a TV Future. Make money in spare time while taking Course. THOUSANDS SUCCEEDING! So can You. Send today for big FREE Book, "You Can Succeed in Television."

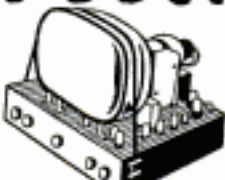

COMMERCIAL TRADES INSTITUTE

Dept. T2-3, 1400 Greenleaf Ave., Chicago 26, Ill.

50



Colorcreting Can Be Your Big Opportunity

Local Colorcretors are Needed Everywhere

Colorcreting is a small investment enterprise, rich in sales potentials, high in income possibilities. Work is easy and fascinating. No experience required; we supply complete instructions.

Colorcreting is a building-beautifying process, with Colorcrete being pneumatically applied to new or old masonry surfaces such as concrete or stucco. Lasts indefinitely—25 years or more. Easily cleaned. Gleaming white, or a choice of 30 colors.

Colorcrete equipment is compact and portable. Easy to operate and practically wear-proof. Easy-payment terms when desired. Write at once for Opportunity Book.

COLORCRETE

Colorcrete Industries, Inc.
578 Ottawa Ave., Holland, Michigan



MASTER MIND!

Learn Short-Cut Mathematics

Juggle figures, do baffling number tricks. Make people gasp at your marvelous lightning-quick calculations. Multiply 4 figures by 4 figures without using old-fashioned multiplication! Big cloth-bound volume; fully illustrated course.

Sharpen up Your Brain Power

Includes worked out problems, answers, etc. Sensational bargain, only \$2.95, postpaid or COD plus postage. Satisfaction guaranteed or refund. Order this amazing "Short-Cut Mathematics" today!

NELSON-HALL CO., 210 S. Clinton St., CHICAGO 6, ILL.

\$2.95 Complete

DAN LURIE
"America's Most Muscular Man"
—on television's "Big Top."

FAMOUS DAN LURIE



BARBELLS

with 4 courses—low factory prices
50 lb. set... \$ 8.48 150 lb. set... \$20.48
100 lb. set... 13.98 200 lb. set... 25.98

Write for Free Catalog Order by Mail; 50% with order, bal. C.O.D. Extra wts. 13c per lb., P.O.B. plant

DAN LURIE BARBELL CO.

1701-M-3 Pitkin Ave., Dept. 459-C, Brooklyn, N. Y.

ANALYZE HANDWRITING

MORE INCOME, Prestige, Success, Fascinating uncrowded profession-business, full or spare time. FREE illustrated lesson & Year Book shows how men and women in home, business and professions analyze handwriting to understand people. MAKE MONEY. FREE lesson and information about unusual opportunities if over 21.



I. G. A. S., Inc., 901 Wilhoit Bldg., Springfield, Mo.

Build Your Own Walks,
Driveway, Outdoor
Fireplace, Steps, Etc.

What to Make With CONCRETE



The terrific high costs of even little concrete jobs are mostly for labor. Get Popular Mechanics WHAT TO MAKE WITH CONCRETE and save all the labor costs while making your home or farm ship-shape. You can lay foundations, sidewalks and driveways; build steps, outdoor fireplaces, sandboxes, tennis courts, garden and swimming pools and other installations at very little cost. Book shows all—tells all—how to make the right mixture, plan, apply and gives 50 professional short cuts. Hundreds of pictures. Only \$2.00 postpaid. Order today. Money back if not pleased.

POPULAR MECHANICS PRESS

Dept. PM17, 200 E. Ontario
Chicago 11, Ill.

POPULAR MECHANICS



IMPORT for BIG PROFITS in MAIL ORDER

Says B. L. MELLINGER—Importer-Exporter



HERE'S PROOF!!

As startling first-hand proof I will send you an actual import from overseas, AT MY COST something to see and use. Just mail me 25¢ in coin and I will rush you this imported Melson Automatic cigarette lighter — made to retail in the U. S. at \$2. This magnificent import will convince you of the tremendous profits being made in World Trade... right now!



BIG PROFITS IN MAIL ORDER

Learn how you, too, may have money and orders delivered right to your door by your mailman. No canvassing—no face to face selling—do it from home by mail. Foreign imports are the source of terrific profits in the mail-order business. The "Old World" offers unbelievable bargains, that are quickly snapped up by millions of mail-order buyers throughout the U. S. Look in national magazines and see ads featuring hundreds of such imports. Fine brassware from India. Glassware from Sweden. Woolens from England. Many other products which are bringing cash in the mail to advertisers.

START AT ONCE WITHOUT CAPITAL

or previous experience. Fantastic profits are possible. My training also includes shipment to you of many sample imports from 'round the world.

"WE OPERATE A PROFITABLE WORLD TRADE BUSINESS FROM OUR HOME, THANKS TO MELLINGER"
—Mr. & Mrs. Beke, N.Y.

GRASP THIS OPPORTUNITY TODAY! Send for your Melson Automatic cigarette lighter now and I will include full details that show you how to learn my Big Profits secrets of World Trade — complete instructions that will put you on the road to a Profitable business of your own. Opportunity to travel abroad for profit and pleasure. I'll also show you how you can save many dollars on your own purchases of Clothes, Tools, Gems, Antiques, Watches, Cameras, China, Silks, Toys, etc. You can have the complete details FREE without ordering the lighter if you wish, but I would like to send you the Melson lighter as an actual demonstration of Import Values. Either way, mail coupon Now. Airmail reaches me overnight.

The Mellinger Co., Dept. 253 1717 Westwood, Los Angeles 24, Calif.

AIRMAIL THIS COUPON NOW

The Mellinger Co., Dept. 253

1717 Westwood Blvd., Los Angeles 24, Calif.

Mr. Mellinger: Show me the big profits to be made through World Trade. I enclosed 25¢ in coin. Send me one Melson Cigarette Lighter and your plan that shows me how to learn the secrets of World Trade. (COUPON GOOD FOR ONE LIGHTER ONLY)

Just send your FREE World Trade Plan.

PLEASE PRINT

Name _____

Address _____

Town _____ Zone _____ State _____

RADIO

Engineering. All phases radio & electronics theory & practice; television; FM; broadcasting; servicing; aviation, marine & police radio. Prepare for high pay: 18-month course. Graduates in demand by major companies. Enter Jan., March, June, Sept. Regular campus life. Write for catalog. VALPARAISO TECHNICAL INSTITUTE, Dept. D, Valparaiso, Ind.

— SAY YOU SAW IT IN POPULAR MECHANICS —

BOAT OWNER!

- Permanently LEAK-PROOF Your Boat!
- No more annual Painting, Caulking.

Apply Liquid Plastic and Glass Fibers. ONCE ON, STAYS ON. Easy to use; economical. Send for handbooks: "How to Make Your Old Boat New" and "How to Build Your Own Fiberglass Boat." Both for 25c. Satisfaction guaranteed. (Bona Fide Dealers Invited.) Marine Div., Dept. MC-1

25¢

CASTOLITE CO., WOODSTOCK, ILLINOIS



OVERHAUL YOUR MOTOR in 10 minutes

STOP BURNING OIL. STOP PISTON SLAP

15,000 Mile Performance Guarantee!

1st Step — CLEANSE WITH "MOTOR PURGE" — In the FIRST step of the famous

Motor Renew Kit treatment, the "Purge" formula cleans, quietens and frees rings, valves and pistons from efficiency and power robbing carbon, gums and varnish. Pour this miracle solvent into the cylinders, run your motor and watch the combustion residue billow out of your exhaust pipe.

2nd Step—RENEW WITH "COMPRESSION SEAL"—RESTORE COMPRESSION... GET NEW POWER, SPEED AND ECONOMY with "Compression Seal"! As the SECOND step of the Renew treatment, squeeze this self expanding mineral compound into your cylinder where it can fill worn spots (which cause compression leaks) between cylinder walls and pistons. Thus it restores compression... cuts oil-gas waste and eliminates costly engine overhauls and ring jobs.

100% MONEY BACK GUARANTEE! Free Auto Manual with each order. Kit treats all cars and trucks. \$6.95 Postpaid (or send \$1 deposit, bal. C.O.D.)

Electronic Developments, Dept. EM-3 10418 Venice Blvd. Culver City, Calif.

Learn the Secrets

BREED RARE tropical fish

KISSING FISH



Proof of tremendous profits!

KIND OF FISH	EGGS OR YOUNG PRODUCED AT ONE BIRTH	APPROX. RETAIL PRICE OF FULL-GROWN FISH
Sweettail	70 to 100	\$3.00 to \$4.00 Pr.
Red Butte	70 to 200	3.00 to 4.00 Pr.
	100 to 100	8.00 to 11.00 Pr.

... IN YOUR HOME... SPARE ROOM, BASEMENT, GARAGE... ANYWHERE!
EARN BIG MONEY—SPARE TIME

New "Chance of Lifetime" opportunity! Start your own spare or full time business once you know the revealing breeding secrets. It's fascinating! It's Fun! Breed EXOTIC and graceful "Angel Fish", BEAUTIFUL "Gourami" that are 12 DIFFERENT COLORS, "Fighting Fish" THAT FIGHT UNTIL DEATH; "Danio" that are STRIPED LIKE A ZEBRA; TRANSPARENT FISH — hundreds of expensive varieties. Some fish lay 300 to 600 eggs at one time. (Some very rare fish have sold for over \$75 a pair.) Get into PARTNERSHIP WITH NATURE and let nature multiply your profits for you. NO EXPENSIVE EQUIPMENT — NO EXPERIENCE NECESSARY. WE SUPPLY EVERYTHING YOU NEED. HELP FILL HUGE DEMAND from stores, offices, theaters, hotels, etc. New plan lets YOUR MAILMAN BRING YOU ORDERS. Investigate TODAY.

FREE! Colorful "How To Do It" success BOOK-LET, REPRINTS, breeding BROCHURE and ALL DETAILS. Rush coupon today!

RUSH this Coupon TODAY!

Tropical Fish Breeders of America, Dept. D-3
3010 S. Los Angeles St.
Los Angeles 12, California

Dear Sir:
Please rush me all Free Details.

Name _____

Address _____

City _____

State _____

Your Age _____



\$5 hourly profit in . . .

Your OWN Business

...Even if NOW Employed

We'll personally train and help you get established . . . starting full or part time.

If reliable and diligent, you can become financially independent in a growing lifetime business of your own. Alert dealers can average \$5 hourly gross profit on service they render plus \$3 on EACH serviceman. Nationally Advertiser services rendered IN homes, offices, clubs, institutions, etc.

DURACLEAN (illustrated above) cleans by absorption. Eliminates scrubbing . . . soaking . . . shrinkage. Dirt, grease and many unsightly spots vanish as if by magic. Wool fibers come to life . . . matted pile rises . . . colors revive. Upholstery and floor coverings last longer.

DURAPROOF (not illustrated) is another year 'round service. Kills moths and carpet beetles. Makes material resistant to both. Protects furnishings, clothing, and auto interiors. Only such service backed by international money-back, 4-year warranty.

Easy to learn. A Duraclean dealer will train and assist you. He'll reveal his successful methods and sales plan. He'll work with you. Your service dealership becomes part of a world-wide organization built upon repeat orders and recommendations from satisfied customers. You have the freedom, prestige and profits of YOUR OWN business.

- No Overhead Expense
- No Shop Necessary
- No Experience Needed
- You Learn Quickly, Easily
- Nationally Advertised
- World-wide Services

Operate from your own home, a shop or office, as you prefer. We furnish enough materials to return your TOTAL INVESTMENT. We help finance reliable men. Start part or full time. Write TODAY for FREE booklet and full details while territory is available.

DURACLEAN CO., 4-163 Duraclean Bldg., Deerfield, Illinois

s. doors Floors Walls

"I saved \$60 on the job" says Mr. Robt. T. Kanney



THAT WAS the price his carpenter had quoted to reconstruct and refinish walls for a bedroom. Worth saving, by doing it yourself? You can; just use this book. **1600 OTHER JOBS** are equally easy when you follow the pictures and step-by-step instructions in "Better Homes Handyman's Book." Written entirely by practical men who have done every job themselves. **THE COST** of this book can be saved in the first job you tackle. It is *guaranteed* to save you money or your entire purchase price will be refunded.

BETTER HOMES & GARDENS
405 Meredith Bldg., Des Moines 3, Iowa

I enclose () check () money order for \$3.95 (In Canada, \$4.50) for my Better Homes HANDYMAN'S BOOK.

Name _____
Street _____
City _____ State _____

Write For FREE Booklet



Patented

A FULL PAGE AD COULDN'T OFFER BETTER VALUE MONTH AFTER MONTH — FOR YEARS YOU SEE OUR AD FOOLISH TO PAY MORE — DANGEROUS TO PAY LESS

FINEST FAMILY-SAFE USED TIRES NOT RECAPS

FREE THIS PICTURED TIRE ASH TRAY AND YOUR NAME WITH TWO OR MORE TIRES

Car \$3 (20 Mo. Guar.) Truck \$11

GOODYEAR, FIRESTONE, U. S. & OTHERS

WORLD FAMOUS	32 MO. GOLDEN RULE	GUAR. BOND
600-16 \$5.05	650-15 \$4.75	750-20TK \$11.80
600-16(6) 5.65	700-15 4.80	828-20TK 16.32
650-16 5.46	700-15TK 8.75	900-20TK 17.34
650-16(6) 6.78	700-17TK 9.85	1000-20TK 16.07
700-16 5.85	600-20TK 7.74	1100-20TK 16.32
700-16(6) 6.95	650-20TK 9.43	1000-22TK 17.34
750-16 7.35	820-15 9.79	1100-22TK 16.45
850-17 6.15	WHITE WALLS \$1.00 Extra	750-16TK 9.35

MUD-GRIP MILITARY TREAD (Army surplus)
750-20 20 Mo. Guar. Super \$9.50; 32 Mo. Guar. Rugged \$14.04
900-16 20 Mo. Guar. Super \$9.50; 32 Mo. Guar. Rugged \$13.25

FACTORY RETREAD MUD-GRIP TREAD TIRES ANY CAR \$7 GUAR. 32 MO.

BLATT PHILA., PA., 11th & SPRING GARDEN ST. Send cl. or M.O. and this ad.
Order from your nearest store MIAMI, FLA., 2827 N.W. 7th AVE.

AMAZING NEW POCKET RADIO

Really Works—Small as a Pack of Cigarettes!

FITS IN ANY POCKET OR PURSE—GETS LOCAL RADIO STATIONS WITH CLEAR BELL-LIKE TONE—NO STATIC OR INTERFERENCE! NEEDS NO TUBES, BATTERIES OR COMPLICATED WOOKUPS! NO AC PLUG IN! Nothing to wear out. Thousands of users—many report years of service. Uses new crystal diode and High coil. SELF-CONTAINED SPEAKER PHONE. Just use the tiny radio to take with you ANYWHERE YOU GO—ON TRIPS, VISITING, ETC.—for real fun and enjoyment—ANYTIME.

SEND ONLY \$1.00 (bill, ck., mo.) and pay postman \$3.99 C.O.D. postage or send \$4.99 for p.p. delivery. COMPLETE READY TO LISTEN. MIDWAY CO., Dept. PPH-3, Kearney, Nebr.

COURSES OFFERED

- Radio Technician • F.M. & T.V. Tech.
- Electronic Tech. (Radar) • Electrical Insp.
- Radio Comm. (F.C.C. Lic. Prep)

Write for Free Booklet

LINCOLN SCHOOL
of Radio & Television, Inc.
1851 B'way, N. Y. C. • CI 6-5300

Say You Saw It in Popular Mechanics

WHOLESALE Electric Guitars - Parts - Build Your Own

Accordions, amplifiers, double-necks, triple-necks, pickup mikes, mandolins, non-electric instruments, etc. 1954 Models wholesale. Free Catalog. Free home study course with instruments. Parts and plans available to build your own G or B string or multi-neck electric guitar.

CARVIN CO., Box 28P, M.3, Baldwin Park, Calif.

UNPAINTED MAPLE LEAF WALL BRACKETS

To Display your Bric a Brac
An Ideal Gift for Friends and Relatives, and an excellent way to fill that empty wall space. Sturdily constructed. Shelf attractively trimmed with polished brass strip.

1 SET (2 LEAVES).....\$2.00
FULL SIZE PLANS.....\$.50

F. & S. SPECIALTY CO.
P.O. Box 275 Phila. 5, Pa.

WANT TO Write Stories

FREE BOOK Articles & Mysteries?

tells how you learn at home

Would you be willing to spend a few hours a week learning to write so you may earn \$300-\$1200 a year part-time? Or many thousands full-time? **FREE** book, "Art of Writing Salable Stories," tells how to get started writing short stories, radio-TV scripts, articles, business items. Many students earn while learning (Graham Doar sold one story to Post, CBS Radio and NBC-TV). Endorsed by famous authors, scores of successful graduates; approved for veterans. Send today for **FREE** book (no salesman will call).

PALMER INSTITUTE OF AUTHORSHIP, Since 1917
1680 N. Sycamore Hollywood 28, Calif. Desk T-34

LIQUID PLASTIC

Pours Like Water
Sets Like Glass

Castolite Do-it-Yourself Plastics require no skill—no special tools. Castolite comes crystal-clear or may be dyed for brilliant color effect. It can be sawed, drilled, turned, carved. You can embed and permanently preserve real flowers, photos, coins, butterflies, insects, stamps, locks of hair, biological specimens, etc.

WHAT YOU CAN MAKE—or repair: Jewelry Castings; Flower Tiles; Coasters; Photo Plaques, Candlesticks; Bookends; Paper Weights; Figurines; Key Tags, Purse Pulls; Buttons; Lamp Bases; Fish Lures; Advertising Specialties; Scientific Displays; Molds; Models; Mechanical Parts. **Leak-proof** boats, tanks, pipes. Repair furniture, gun stocks, etc. Build new boats, surf boards, tanks that will never rust—many other things.



25¢

SOUND PROFIT OPPORTUNITIES SAVE money. Make money, have fun! You can get professional results even in your kitchen. "How to Cast With Castolite" tells all! Only 25¢—includes **FREE** manuals! "How to Make Jewelry" and "Home Success Plan." Write Dept. C-1.

THE CASTOLITE CO., Woodstock, Illinois



LEARN MODERN WATCH AND CLOCK REPAIRING

Complete Course—Only \$5.95

At home, spare time. Good field now... security and contentment in future. Start part-time business and **EARN** while you learn. Horology is precision instrument work... a great and growing field, sensational opportunities. Easy self-instruction course. Full price, only \$5.95. **SEND NO MONEY.** Just pay postman, plus C.O.D. postage. Or send \$5.95 with order, we'll ship postpaid. Satisfaction guaranteed or refund. **NELSON-HALL CO., 210 S. Clinton St., Dept. 3CW-2, Chicago 6, Ill.**

Finish HIGH SCHOOL AT HOME

Complete 4 Yrs. in 12 Months

Learn More! Earn More! Enter professional or technical schools. Advance Socially. Live a Happier, Fuller Life. Individual Courses or complete schedule. **WRITE FOR SCHOOL BULLETIN.**

ACADEMY FOR ADULTS

30 W. Washington, Dept. PW-304, Chicago, Ill.

Wore ordinary spikes on this shoe



Wore New NO-KLOG on this shoe

CALLING ALL GOLFERS!

New, light self-cleaning **NO-KLOG** golf spikes can save your feet lifting up to 3,700 lbs. of mud, metal, leaves in 18 holes! Easy to attach (fit old spike sockets) with special wrench included with Set of 28 No-Klogs. Only \$3 postpaid. Satisfaction guaranteed. Order now! (Dealers write.) **LIFEGARD CORP., 4114 N. Knox Ave., Dept. G-134, Chicago 41.**

Monogram SPEEDEE-BILT

New Models

FUN TO ASSEMBLE
ALL PARTS FINISHED



PANTHER JET

THUNDERBOLT

Navy and Air Force Planes With Full Armament

At Hobby Stores or by Mail.

If no dealer near you send \$1.25 for one kit, postage and packing. \$2.25 for two. Save 25¢ on two. Delivery guaranteed.

Here are the two newest models in the famous Speedee-Bilt flying model series. Only \$1 each for Panther Jet P-9F and Thunderbolt P-47. Easiest models to build. Build one complete and fly it in an evening. Use Jetex engine for the Jet job. Power rubber supplied for the Thunderbolt. Kits contain built-up Monofoil wing, pre-fab fuselage, finished wood parts and 14 molded plastic parts including prop, pilot, canopy, machine guns, rockets, and other parts. Catalog of other models in each kit. Write today.

MONOGRAM MODELS, Dept. 13, 3421 W. 48th Place, Chicago 32

FAST, SMART & SNAPPY

FOLBOT

FOLDS IN TWO LIGHT BAGS

Paddles • Outboards • Seils

Versatile, stately, streamlined craft; wide beam, large decks, low center of gravity for sturdy performance with greatest safety record. Weighs only 63 lbs.—loads 750 lbs.—3 people and gear. One person can handle it. Easily packed and stored, fits inside car trunk. Wonderful for cruising, hunting, fishing in open seas, surf, rapids, or rocky waters. Rock-resistant and leak-proof. No upkeep or fees.



Set up in a jiffy. No tools required.

BIG CRAFT
NOW ONLY

\$95.—

and up

Since 1933, thousands of enthusiastic Folbot users.

FREE

Giant Illustrated Catalog
Write Today: **FOLBOT CORP., Stark Industrial Park, Dept. P. M., Charleston, S. C.**

A GREAT 22 CAL.

AUTOMATIC

FOR ONLY

\$31.95*

15-shot magazine
Straight line feed
Open sights...
Monte Carlo stock

Model 151K

22 cal.

15-shot "auto"

Amazing quality and dependability. A masterpiece of gunsmithing!

SEND FOR FREE CATALOG

*(\$32.95 West of Rockies)

YOUR MOSSBERG DEALER WANTS TO SHOW YOU THIS ONE
Compare it with the finest!

No sales at factory.



O. F. Mossberg & Sons, Inc.
49703 St. John St., New Haven 5, Conn.

FREE

SEND FOR THE

1954

ALLIED

268 value-packed pages

TV & RADIO CATALOG

WORLD'S MOST COMPLETE

Save on everything in TV and RADIO

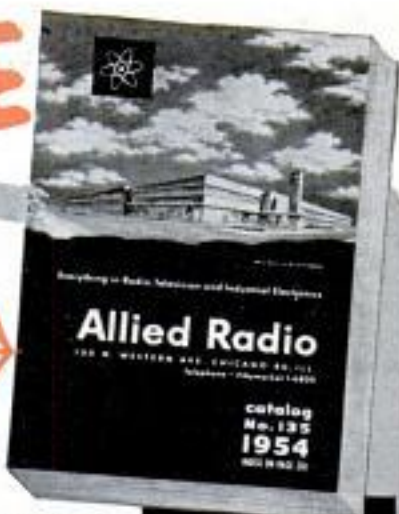

Everything for Experimenters, Builders, Amateurs, Servicemen, Engineers and Soundmen

Send for ALLIED's big 268-page value-packed buying guide to everything in TV and Radio! Largest selections of custom TV chassis, TV accessories, FM and AM radios, High-Fidelity Sound, Amateur supplies, P.A. Systems, recorders, test instruments, builders' kits, industrial electronic supplies—plus the world's largest stocks of electronic parts, tubes, tools and books. Get everything—get more for your money—send today for your FREE 1954 ALLIED Catalog.

NEW HOME OF ALLIED RADIO



ultra modern facilities TO SERVE YOU BEST

SEND FOR FREE CATALOG

ALLIED RADIO

ALLIED RADIO CORP., Dept. 5-C-4
100 N. Western Ave., Chicago 80, Illinois

Rush FREE 1954 ALLIED 268-Page Catalog

Name _____

Address _____

City _____ Zone _____ State _____



WORLD'S LARGEST STOCKS

Shrinks Hemorrhoids Without Surgery

Science Finds Healing Substance That Relieves Pain—Shrinks Hemorrhoids

Science has found a healing substance that shrinks hemorrhoids, stops pain promptly, ends bleeding—without surgery. Doctors report actual shrinking of hemorrhoids. Sufferers say, "Hemorrhoids have ceased to be a problem." The secret is Bio-Dyne®—already widely used for healing injured tissue. This substance is now available in a hemorrhoid ointment called Preparation H®. Ask your druggist for Preparation H. Money back guarantee. *Trade Mark

Wheels Wheels



Wheels Wheels

7" Disc Wheel 3/4" Tire 3/4" sleeve	45c ea.
8" Disc Wheel 1 1/8" Tire 1 1/8" sleeve	70c ea.
7" Disc Wheel 1" Tire 3/2" ball bearing	80c ea.
8" Disc Wheel 1 1/4" Tire 1 1/2" ball bearing	\$1.00 ea.
6" Disc Wheel 1.50 semi-pneum. Tire 1/2" S.B.	\$1.35 ea.
8" Disc Wheel 2" semi-pneum. T. 1/2" S.B.	\$1.50 ea.
10" Disc Wheel 1.75 semi-pneum. T. 1/2" S.B.	\$1.50 ea.
10" Disc Wheel 2.75 semi-pneum. Tire 1/2" S.B.	\$3.50 ea.
12" Disc Wheel 1.75 semi-pneum. T. 1/2" S.B.	\$1.85 ea.

Above wheel prices includes hub cap. Plus Postage, C.O.D.'s accepted. AXLES—Size 5/16 in., 3/8 in., 1/2 in.—Cut to size—End holes drilled.

UNITED WHEEL STAMPING CO.
12131 S. PEGORIA STREET PM-3 CHICAGO 43, ILLINOIS

FUN AND PROFIT



Amazing number of uses for these Swiss Music Movements. Music boxes, musical toys. CHRISTMAS, NURSERY, WALTZES, POPULAR TUNES. Many patterns—15c ea. SPECIAL—Free pattern with purchase. Send \$2.50 for unit. Guaranteed to delight you. Further information upon request. A profitable hobby. GET STARTED NOW!
MARITIME—13 East 60—New York 22, N. Y.

HERE'S A PROFITABLE BUSINESS FREE!

MONEY MAKING OPPORTUNITY FOR YOU WITHOUT INVESTMENT!

No experience needed to act as our Local Dealer for **MASREN Work Uniform garments**. Every business concern a prospect. Advertising embroidered on garments is a big sales feature. Stores can't compete. You can easily earn up to many thousands of dollars yearly. We supply all Sales Equipment FREE. Write **GEO. MASTER GARMENT DIV.** 195 WATER STREET, LIGONIER, INDIANA



POWER MOWERS & KITS

FREE PLANS

LOW FACTORY PRICES DIRECT TO YOU

Build your own quality mower with our LOW COST KITS, Parts, Engines. Free Plans guide you. 3 and 4 Wheel Kits, complete. Parts precision finished, ready to use. Write TODAY for Free Plans, Low Prices, Parts List and Guarantee.

3 & 4 Wheel Model

4 Wheel Direct Drive



3-WHEEL KIT NO. T-800



America's Finest Power Mowers completely assembled in 3 and 4 wheel models. Belt or direct drive. 18" and 20" sizes. Nationally known make engine. Latest improved features, sturdy construction and money back guarantee fully described in color folder. Write today.

TRIANGLE MANUFACTURING CO., Box M-28, Fort Scott, Kansas



The World's
Most Modern
Masonry



Opportunities Open for Local Manufacturing

From local plants dotting the country has come the Brikrete used to erect many thousands of buildings—homes, apartments, motels, stores, shopping centers—practically every type of residential, commercial and industrial construction. Why?

Because Brikrete has more quality features than any other fine masonry—design, size, light weight, insulation properties, range of 14 colors. And a price competitive to lumber! It's an outstanding business opportunity.

High Income Potentials

Freight and distribution costs are by-passed in the manufacture of Brikrete. By using local aggregates and local labor it's a "direct to user" business. Production economies enable low prices to consumers and generous profit margins to manufacturers.

More plants are needed to operate in protected territories under franchise privileges. Basic machine available on lease or purchase. Write for Brikrete Book No. 2.

Brikrete Associates, Inc.
4679 Division Ave., So.
Grand Rapids 8, Mich.

BRIKRETE

60,000 AUTOS STOLEN '53

**SENSATIONAL NEW INVENTION
STOPS AUTO THEFT**

New patented "DRIVE-LOK" invention instantly freezes car steering into theft-proof safety. Hardened steel construction. Complete with two keys. No installation necessary. Fits all modern cars. Takes split second to use. Stop car theft risks forever. Satisfaction guaranteed or money back. Send \$3.95. We ship postpaid. Order now.

HOLFORD & CO., Dept. 1, Mathieson Bldg., Baltimore 2, Md.

NO TANKS USED
NEW SIMPLIFIED METHOD

ELECTROPLATE

ANY OBJECT IN HOME, SHOP, GARAGE OR STORE!
YOUR OWN WELL PAYING ELECTROPLATING BUSINESS!

NOW, using NEW plating kit, it's easy to electroplate any object. Complete kit and instructions on plating metal and non-metal objects, with nickel, copper, chrome, gold, etc., plus full data on obtaining all the business you desire and make **BIG MONEY** full or spare time. **ONLY \$5.95. SEND NO MONEY**—everything sent C.O.D. plus postage—OR send \$5.95 now and receive it postpaid. Money back in 7 days if not satisfied.

M. Z. NATIONAL SALES CO., 144-X Henry St., N. Y. 2, N. Y.

Now you can **MULTIPLY or DIVIDE**
in a Flash—
WITHOUT PENCIL OR PAPER
with the **MULTIVIDER**

Fastest, simplest calculator for quick calculations in existence. No special knowledge required. **JUST TURN THE DISCS** to the two numbers you wish to multiply or divide—and **READ YOUR ANSWER**. That's all there is to it. You can often do a whole list of problems with a single setting. **ENORMOUS TIME-SAVER** for contractors, engineers, business men, students, etc. Ideal for quick estimates, converting measurements, figuring mark-ups, profit percentages, stock or bond yields, etc.

New improved models on Durabux base for long service—9" diameter, with cursor—\$5.00 postpaid. Pocket size—5 3/4" diameter \$2.00. Satisfaction guaranteed or money refunded if returned within 5 days. Order today.

CALHOUN'S, BOX 887-PM, SPARTANBURG, SOUTH CAROLINA

FREE BOOK AND ACTUAL SAMPLE

Screen Print, Dept. 23
1010 S. Los Angeles St.
Los Angeles 15, California

Dear Mr. Nowak: Please rush me **FREE BOOK, ACTUAL SAMPLES**, and your amazing new **PRINTING PLAN**

Name _____
Address _____
City _____ State _____

**IT'S AMAZING! I'll show you
how to make up to \$12.50 per hour**

PRINTING WITHOUT A PRINTING PRESS

AMAZING NEW COLOR PRINTING METHOD
A fascinating new miracle-way to print—a secret method that lets you print colorful signs, posters, banners, drapes, wallpaper, flasks, glass, fabrics—**ANYTHING** without an expensive printing press or costly equipment. This new process is revolutionizing the entire printing industry—it's one of America's fastest-growing businesses—it's your "chance of a lifetime" to make Big Money Now! Be the **FIRST** in your area to profit. The secret can be yours—just mail the coupon above today!

EASY TO LEARN! NO EXPERIENCE NECESSARY!
Simple fascinating method! No artistic ability needed. It's possible for anyone (young or old) to make up to \$50 PER WEEK printing in **SPARE TIME** alone—**AT HOME!**

START YOUR OWN BUSINESS—BE YOUR OWN BOSS
Wouldn't you be happy if you could take only one hour of your time and \$1.00 worth of materials—and sell your printing for \$15 or more. It's that easy! It's amazing! Your home can be your office—No selling because there's a huge demand everywhere. **GOVERNMENT CONTRACTS AVAILABLE TO BID**. Biggest opportunity in America—costs you nothing to receive all **CONFIDENTIAL FACTS**—Mail coupon today!

SCREEN-PRINT
1010 S. Los Angeles St., Los Angeles 15, California

Print paper of all kinds
PRINT BANNERS
PRINT FABRICS
PRINT INSTRUMENTS
PRINT SIGNS
FOR SALE
YOU CAN PRINT ANYTHING WITH

SCREEN-PRINT

**PREPARE FOR BETTER JOB, BIGGER PAY
IN SPARE TIME AT HOME**

Today, choose the job you want—and prepare for it in time you might otherwise waste. Or if you are already in the work you like best, start training now for quicker promotion and increased pay. During more than 50 years **AMERICAN SCHOOL** has helped ambitious people to reach higher goals. Check subject that interests you and mail coupon for full information.

AMERICAN SCHOOL, Dept. G345, Drexel at 58th, Chicago 37, Ill.

Without obligation, please send **FREE** and postpaid, full particulars about the subject checked below.

Accounting
Air Conditioning
Architecture & Building
Automotive Technician
Better Foremanship
Bookkeeping
Business Management
Contracting
Diesel Technician

Drafting—Building Trades
Drafting—Machine Trades
Electrical Engineering
Electricity—Practical
Electronics—Industrial
High School Courses
Machine Shop Operations
Mathematics & Slide Rule
Mechanical Engineering

Plastics Engineering
Plumbing—Practical
Private Secretary
Refrigeration
Retail Merchandising
Salesmanship—Outside
Sheet Metal Work
Tool Making

NAME _____ OCCUPATION _____
HOME ADDRESS _____ AGE _____
CITY _____ STATE _____

MAIL COUPON NOW

Start a profitable manufacturing business in spare time

with your own home as your headquarters

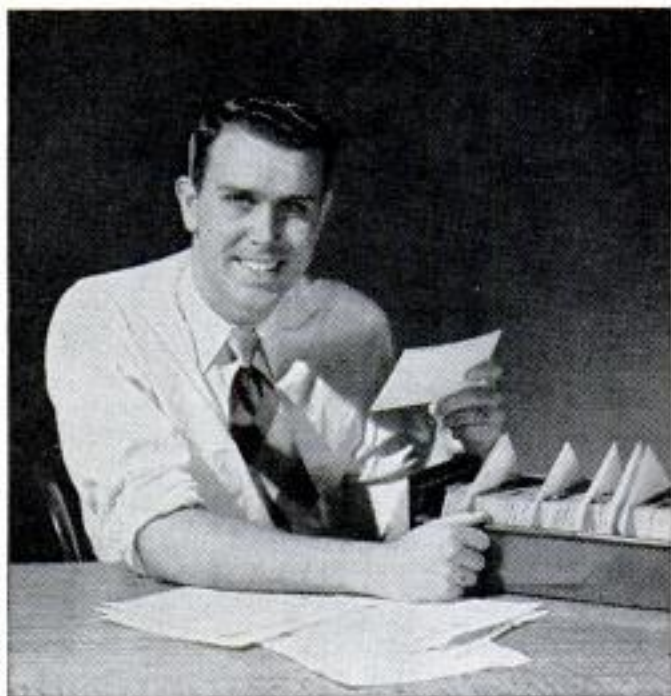

RIGHT at this moment there is a tremendous demand for new business enterprises in a branch of the plastics industry. Fortunately, this is a type of manufacturing business that does not require heavy or expensive machinery, rented space for storage, production or sales. A portable hand machine does the work wherever electric current is available, and the working area can be in almost any part of your home.

The opportunity that is open to you today, is to meet this growing demand in a new industry by establishing yourself as the manufacturing agent in your own trading area. Several hundred of our machines are already in use in both large and small communities. Some are even being operated successfully by women whose family duties make it necessary for them to be at home during the day, but whose family income is not enough to meet rising expenses. Most are being operated by men. Many started in spare time just to pick up an extra five or ten dollars for an evening's work. They found the work so profitable that some have now given up former jobs to devote full time to a business of their own.

One of our manufacturers gets all of his business by mail. Orders and money come to him in envelopes and he sends his products out the same way. Another delivers his entire output to stores in the vicinity. An-

other does a wholesale business supplying other manufacturers who do the selling. Still another works with advertisers in the manufacture of plastic advertising novelties and specialties.

The operation of the machine is simple and easy for anyone to learn. It does not require any knowledge of chemistry, mechanics, or electricity. And what some say is best of all, a manufacturing business like this enables a person to make good money without any house to house canvassing. The machine turns out from \$5.00 to \$15.00 worth of work per hour and it can be operated for as short or long a time as you wish.

We have prepared a simple step by step instruction manual that not only tells how to operate the machine, but also tells how to get the business coming in at a profitable clip right from the start. We will lend a copy of this book to any serious minded man or woman with the

understanding that a copy will be given them free if and when they purchase a machine—or the copy we lend can be returned if you decide not to go into the business. Reading it will not cost you anything.

If you are interested in a nice little home business that can bring in an extra \$60 or more for ten or twelve hours work in spare time, send your name. All information on the book and machine will be sent free, postage prepaid and no salesman will call to bother you. You read about it in the privacy of your own home without outside pressure and then decide whether you'd like to take the next step. Address your envelope to me in person. Send me the coupon below. Or, if you prefer send your name on a post card and ask for "Free information on starting a manufacturing business at home." Either way, send your name today and find out about this wonderful new fast growing money-making business.

RAYMOND E. BRANDELL

1512 Jarvis Ave., Dept. L-10-C, Chicago 26, Ill.

Raymond E. Brandell, 1512 Jarvis Ave., Dept. L-10-C, Chicago 26, Ill.

Dear Mr. Brandell: Please send information showing how I can start a profitable manufacturing business in my home in spare time. All the information you send will be mailed to me free of charge and no salesman is to call on me. I am not under any obligation to go ahead with the business and there is no charge for this information now or any other time.

Name _____

Address _____

City _____ Zone _____ State _____

POPULAR MECHANICS

**WORLD'S
BEST
WANT AD
MEDIUM**

CLASSIFIED Advertisements



Advertisements in this section \$1.00 per word, each insertion, minimum 10 words, payable in advance.

To be inserted under proper classification, copy must be in our office the 20th of the second month preceding date of issue

F. W. Johnson, Manager, Classified Advertising

Popular Mechanics Magazine, 200 East Ontario Street, Chicago 11, Illinois

YOU'LL PROFIT

By reading and answering the classified ads in this section. Hundreds of opportunities for you to make and save money

AUTOMOBILES, MIDGET CARS

ANTIQU Automobile color slides, 2x2. Illustrated catalog free. Universal, Box 779A, Beverly Hills, Calif.

MIDGETS—Prints for home construction. \$2.50 e.o.d. Magnesium, for wheels and rear ends. Free information. WRFM Mfg. Co., 2344 Dudley, Dept. F, Pasadena 7, Calif.

200 MILES Gallon (V-8, 45 m.p.h.). Diagrams \$1.00. Carburetor, Asbury Park, N. J.

GENUINE Motor treatment, Lachapelle's, (patented). Only \$3.00 delivered. Restores compression, power. Saves gas, oil, repairs. Money back guarantee. You can't lose. Free circular. Write Joe Dillon, Authorized Warehouse and Agents Distributor, Box 323-S, Bridgeport, Ohio. Distributorships, agencies open.

FIBERGLAS Automobile bodies. Build your own. Maurice Lannon's Fiberglass "How" book—\$2.50. Information, materials catalog, 10c. Airmailed, 35c. Gem-O-Lite, Box 6867A, North Hollywood, California.

SELL, Restored 1936 Cord—\$1500.00. Pictures, \$1.00. Greenlee, Box 1036, Anderson, Indiana.

HI-Mileage—speed equipment from the world's largest supplier. Dual manifolds, finned heads, electric doors, lowering sets, chrome panels, thousands of items for all cars. 1954 catalog 25c (illustrated literature free). Wholesale to garages. Newhouse Automotive Industries, Los Angeles 22.

NON-PROFIT Organization offers automobile literature—Old, new and foreign; dealer books; mechanic's manuals; glossy photographs; free motor magazines. Write today; get on free mailing list. Auto Maniacs, Stockbridge, Mich.

SPEED Shangri-La! Racing, rodding, restyling requirements. Al Price, 64 Alton, PM-3, Rochester 12, N. Y.

EXHAUST Header handbook, plans, details, completely illustrated. You can make, sell headers. Huge profits. Material at wholesale. Send only \$1.25 for valuable book. Exhaust Supply Co., Dept. P, Box 6128, Lakewood, Calif.

AUTO SUPPLIES AND EQUIPMENT

NEW Automobile and truck heater motors wholesale. 25,000—All sizes, all voltages. Send in your old one for exchange or repair. Windshield Wiper Service Co., 911 W. 69th St., Chicago 21, Illinois.

CAR Battery low? Here's how to rejuvenate it. For complete instructions send \$1.00 to: Allen, 14 Loomis St., Devon, Conn.

AUTO Radios at wholesale. Last free. Regent, 801 Erie, Philadelphia 40.

LACHAPELLE'S Treatment. Patented. Makes any gasoline motor better. Only \$3.00 postpaid. Write for free information. Ferns Products, #120-B Walnut Dr., Los Angeles 1, Calif.

GM71 Discarded injector parts wanted. Bares, 7120 Carnegie, Cleveland 3, Ohio.

ROXANNE! New auto upholstery and rug cleaner. Just apply and let dry. Results guaranteed. Large size \$2.49. Flynn Bros., 455-12 St., Brooklyn, N. Y.

NATIONALLY Famous attachment checks crankcase oil from drivers seat. Avoids costly repairs! Easily installed. Half price by mail. Postal brings illustrated literature. Wenonah Sales, Winona, Minnesota.

NEW And used parts at savings. Complete guaranteed parts service for all models cars and trucks, late or old. Largest in the west. Army parts specialists. No catalog—Write for quotations. Fast mail order service. Pioneer Auto and Truck Parts Co., 734 W. 13th Avenue, Denver, Colorado.

FORD-T Parts—Engine and chassis. Parts for other old models too. Special parts made to order. We buy surplus items. B. S. Wisneski, Milwaukee 7, Wisconsin.

SENSATIONAL Free trial offers! Surplus stock of famous Gale Hall automotive instruments, brand new, original cartons! Try at our risk for seven days, then send payment or return merchandise! Professional compression testers, originally \$10.75, now \$2.98! Engine analysis vacuum gauges, originally \$12.50, now \$4.55! Fuel pump testers, originally \$8.10, now \$3.09! Original Gale Hall motor condition/gasoline economy gauges for permanent dashboard mounting. Originally \$7.50, now \$2.98! All prices plus 40c postage. Order now! New England Surplus Sales, Dept. PM-3, Newburyport, Mass.

REFLECTING Comic bumper stickers 25c each. Slonaker, Box 3503D, Jacksonville 6, Fla.

STOP Flat tires, puncture proof any auto tire for only \$1.98. Easy, simple, guaranteed. Free information. K. & B. Sales, 607-M Market Street, San Francisco 5, California.

CRANKSHAFT Grinder, hand operated. Makes bearings fit without taking engine apart. \$3.75. Literature. L. D. McGee, 719 Cascade St., Wenatchee, Wash.

CAR Trunk hold-lite straps. Secures expensive luggage, tool boxes, sporting equipment, etc. Simple installation. \$3.00 postpaid. Hi-Way Queen, Wyocena, Wis.

ENGRAVED Chrome car door name plates, three initials \$1.00, full name \$2.00. Shea Engraving Service, 224 Oak St., Natick, Mass.

AVOID Accidents—Insure clear vision \$1.00. "Safety" inside windshield wiper cleans fog instantly. Guaranteed. Jumbo size \$2.00. Strong's, 4217 E. 14th St., Oakland, Calif.

CARBURETORS. Save 50%. Guaranteed factory rebuilt exchanges. Jules Carburetor Exchange, 10452 Magnolia, No. Hollywood, Calif.

BALANCE Wheels without special equipment. Save money—Make money. Box 316, Berkeley City 21, Mo.

CRUMBLISS Super coil. Literature. Also special automotive tool catalog. White's, Catawissa, Penna.

ROLLS Auto chains on, \$1 pair. H. W. Newton, Simpson, W. Va.

BUY Wholesale nationally advertised auto supplies, thousands other products at big discount. Free "wholesale plan." American Buyers', 629-D Linden, Buffalo 16, New York.

AIR Conditioner, save \$500.00! Equip your car for \$149.70 with complete kit. Free literature. Seeley, 3038 Addison, Chicago 18, Ill.

RADIOS—Custom for 1952-3-4 Fords \$38.90. Free literature. Nordic Radio, Box 582, Evanston, Illinois.

NEW Type emergency tire chains. Most convenient, sturdy. Motorist's friend snow, mud. Quick on. Guaranteed. \$5.98 set (4), prepaid. Name car, tire size. Konev-yunt Chain Co., 1406 Cherokee Road, Richmond 25, Va.

CUSTOM Accessories headquarters. Electric push button doors-trunks, bull noses, custom grilles, speed dress-up equipment. 40 page catalog hundred photos—25c. Eastern Auto, 3319A South Grand, Los Angeles 7, Calif.

BUILD Your own custom 1954 low cost Fiberglass body. Construction manual \$1.00. United States Fiberglass-Resin Company, 722 East Washington, Los Angeles 21, Calif.

WHOLESALE Automobile supplies. Catalog 25c (refundable). Charles Wholesale, Batesville, Arkansas.

ELECTROPLATE Auto parts, novelties, mirrors. Easy, inexpensive home processes. Free booklet. Tyco Metals, Box 13231-BG, Houston 19, Texas.

CHEVROLET Owners: Stop tappet noise with Kaye Tappet Silencers. Quality product. Easy to install. Complete set \$5.95. Kaye Products, 2067 B S. Layton Blvd., Milwaukee, Wis.

"WATER Injection." Free descriptive, illustrated, information. Neher Industries, LaVerne, California.

BRUSH Plating outfits connect to a battery. No tanks or shop required. Free particulars. Gunmetal Co., Ave. J., Decatur, Ill.

CAR Burning oil? Losing compression? Try Clifford's Compression Seal. \$2 postpaid. Clifford's Engineering, 1329 Seventh, Aurora, Illinois.

AUTO TRAILERS

EXCEPTIONAL Expanding eight foot trailer. Accommodates family of five. Build yourself. Literature 10c. Fra-Mar Company, Jones Avenue, Wilmington, Mass.

TRAILER Building, illustrated, 20c. Craftsman Books, Box 1153, Milwaukee 1, Wis.

ALUMINUM Camp trailer kit. Campers, hunters, fisherman, Sleeps four. Compact, folding. 560 lbs. Literature 10c. Master Camper, West Sayville, N. Y.

BUILD Your own trailer! Plans for all kinds. Illustrated catalog 10c. Jim Dandy, 125-M, Wausau, Wisconsin.

MOTORCYCLES, BICYCLES, MOTORSCOOTERS AND SUPPLIES

HARLEY-Davidsons—America's best used buys! We pay shipping on motorcycles. Genuine new, used, parts, accessories for current and obsolete models. Send 25c for bulletin, catalog. Knuth's (Harley-Davidson factory dealer), 1753 Muskego, Milwaukee, Wis.

NSU Motorcycles, 5 to 22 h.p. NSU Quick motorbike 3 h.p. New NSU Quickly motorbike \$199.50. Fast part service. Ask for folder. Some dealerships open. Butler & Smith Trading Corp., 117 West 63rd St., Dept. P, New York City.

2½ H.P. Whizzer \$18.50; midget car \$15.00; Doodlebug motorscooter \$37.50; homemade motorscooter \$6.00. Send 25c (35c first class mail) for catalog #24 jammed with sensational bargains in wheels, motors, motorscooters, midget cars, motorbikes, construction plans, etc. Gail, 1313 Jefferson, Toledo, Ohio.

VILLIERS Motorcycle \$45, Harley \$40, electric automobile \$55, two-cylinder Maytag \$8, Briggs \$5, Indian four cylinder engine \$15. Four airplane tires \$3. Mailorder only. Send 25c for new catalogue Number 58, listing these and hundreds of other bargains in new and used midget cars, motorscooters, parts, plans for homebuilders, etc. 35c by first class mail. Midget Motors Directory, Athens, Ohio.

ENGLISH Bicycles, Import direct. Free details. Home, 1500 Harvey Road, Wilmington, Delaware.

"BUZZZZ"—The motorcycle magazine. International coverage. Thoroughly illustrated. Yearly \$2.00. Sample 20c. 5424-A Sawyer, Chicago 25.

RECONDITIONED Motorcycles and motors. Chromium accessories. Complete stock Indian parts. Expert rebuilding. Fast service. Indian Motorcycle Sales, Kansas City 27, Mo.

AVIATION

SNOW Sleigh—air boat propellers. Literature. Universal Propellers, Box 3123A, Ft. Worth.

PROPELLERS. Plans, supplies for air boats, snow sleighs. Catalog 25c. Banks-Maxwell, Box 3301E, Ft. Worth, Texas.

LIGHTPLANE Circular, illustrated, 20c. Craftsmann Books, Box 1153, Milwaukee 1, Wisconsin.

FREE: Monthly aircraft, electronic, gadget list. Dick Rose, Everett, Wash.

PROPELLERS. Plans for snow sleighs, air boats. Lowest prices, fastest service. Literature. Gano Propeller, Box 3284A, Ft. Worth, Texas.

BATTERIES, GENERATORS

EDISON Nickel odorless storage batteries. 12 to 600 ampere hour. Any voltage. Long guarantee. Literature. Hawley Smith Co., Croton Falls 1, N. Y.

ELECTRICAL SUPPLIES

ONLY 10c Brings plans for d.c. welder from aircraft generator. Anyone can build the LeJay easy way. Parts catalog and electrical information booklet sent free with each order. Send dime today. LeJay, 347 Minneapolis, Minn.

WELDERS—Electric, various models, \$38.50 to \$235.00, direct from manufacturer. Free literature. Champion Welder Mfg., 193MP Centre St., New York 13, N. Y.

TOOL Crimps, splices, cuts, strips wire. Shears bolts. Garrahan, 4747 Apartado, San Juan 24, Puerto Rico.

ELECTRICIAN'S Tool for making solderless connections that enables anyone to do professional-like jobs. Crimps terminals and connectors. Splices, cuts and strips wire. Shears bolts without damaging threads. Complete kit; tool, terminals, connectors and insulators, formerly \$5.00, now \$3.95 postpaid. Aircraft Marine Products Inc., 1330-C, American Building, Cincinnati 2, Ohio.

LAMP Supplies—Wholesale, any amounts. All parts for repairing and building lamps. Catalogue 15c. Brown Lamp Co., Box 501—Wellston Sta., St. Louis 12.

ELECTRIC Pencil: Engraves all metals \$1.50. Beyer Mfg., 10511-H Springfield, Chicago 43.

LAMP—25c Brings bargain catalog showing all parts for repairing, building. Contains instructions for electrifying vases, oil lamps, etc. Gyro Lamps, 5402P Clark, Chicago 40.

WELDING, SOLDERING, PLATING

"BUILD-UR-OWN" a.c. welder and a.c. power plant with a good used engine and low cost Hobart generator. Welds anywhere and supplies 5KW stand-by power for any emergency. Write Hobartweld, Box M-343, Troy, Ohio.

ELECTROPLATING Outfits \$4.95. Gold \$5.95. Ideal for small articles. Hobby or business. Free information. Capitol, 4213 Queensbury Road, Hyattsville, Maryland.

ACETYLENE Welding outfits. New \$49.00, used \$29.00; arcwelders \$49.50. Dept. PM, Eagle Welding, 5085 Broadway, Chicago 40, Illinois.

SELF-Training System. Radiator repairing, cleaning, recoring. How to equip small shop at low cost. Supply sources, trade secrets. Instructions. Radiator Service, McBain, Mich.

ELECTRO Plating equipment—New and used. Complete assemblies. All sizes for all types of plating. Baby shoe metallizing sets. Mounts, supplies, instructions. Free catalog. Hollywood Bronze Supply, 1624-C E. First Street, Los Angeles 33, Calif.

MACHINERY, TOOLS, SUPPLIES

CONCRETE Block machines. Standard sizes. Free catalog. Concrete Machine Company, 5129 South Compton, St. Louis 11, Missouri.

20c BRINGS Warehouse bargain catalog. Card's, Edgewood Drive, Niagara Falls, New York.

METAL Cutting shaper, 10 inch swing. Has taper bearing and automatic feed. Write Sheriff Tool Co., 700 Washington, Albany 6, Calif.

RED Head—New type special faced polishing head. ¼" shank. Metal, autos, wood, \$3.50 p.p. Cox Industries, Box 265, North Hollywood, Calif.

BIG Tool catalog. Send 50c. Yuhas, 3350 Theodore, Detroit, Michigan.

ALLEN One ton power bench type punch press. \$97.50. Circular Allen, Dept. PMB, Clinton, Missouri.

BIG Factory catalog! Buy direct—Save middleman's profits; hundreds of labor saving tools and equipment; tremendous savings. Send 10c. Master Mechanic Mfg., Dept. C-32, Burlington, Wis.

ONLY \$3.95. Precision 2" universal lathe chuck, \$14 value. Har Mur, 2349 Devon, Chicago 45, Ill.

NEW 1954 All steel drill press vise, hardened jaws, \$9.95. Free circular. Sypher Co., 202-Cherry St., Toledo, Ohio.

SHEBEL Saw filer. Files all saws. Circular. A. P. Shebel, 730 S. 2nd St., Milwaukee 4, Wis.

ENGINES, MOTORS, DYNAMOS

INVALUABLE Motor winders handbook. Simplifies complicated reconnecting. Jednak, Clinton, Penna.

ALTERNATING Current generators, 750 watt \$38.50, 5000, \$185.00. Motors, 1 horse \$37.50, 2, \$67.50, 3, \$87.50. Butler, 1885 Milwaukee, Chicago 47.

ELECTRIC Motor winders, send for bulletins. Motor Industries, Quincy, Illinois.

110 VOLT 60 Cycle alternating current generators, range 150 to 300 watts, \$25.00. Send check or money order. Other sizes and complete power plants, assembled and disassembled. TrailLite Corporation, Three Rivers, Wisconsin.

REBUILT Gasoline engines, \$17.00 to \$37.00. Caulfield Motor Industries, Temperance, Michigan.

WINDING Data, 225 motors, single and three phase, \$1.00. Data Company, Box 7631, Kansas City 28, Mo.

AUTOMATIC Oiler for electric motors, 3 for \$1.00. United States Petroleum Co., Dept. 3, Clifton, New Jersey.

BOATS, OUTBOARD MOTORS

BOAT Kits. Build your own boat. Easy to follow instructions. Literature free. Paramount Boat Company, 2203 N. Prairie, Joliet, Illinois.

"P38" Belly tanks, \$9.95. Free picture. Anzio Boat, 89, Merced, California.

"HOW To Make Your Old Boat New With Liquid Glass" and "How To Build Your Own Fiberglass Boat." These 2 illustrated manuals show step-by-step method. Both for 25c from Marine Div., Dept. MC-101, Castolite, Woodstock, Illinois.

BIG Savings manufacturer to you. Ford, Mercury water cooled manifolds, \$60.00 value, now \$42.50. Racing or ski cracker-box plans, \$5.50 value, now only \$1.50. 1954 illustrated marine catalog 35c refundable. Debbold's, Lynwood 23, Calif.

HARDWARE. Kit, catalog, 15c. Boat-builders Marine, 55 Sorrento, Allston, Mass.

AIRPLANE Floats (pontoons) for boats. Catalogue 10c. Ort, Thomasville 33, Penna.

PLANS For deluxe utility runabouts, outboards and inboards. Specify requirements for literature. Glen Designs, Box 568, Compton, California.

FIBERGLAS Your boat for permanent waterproofing. Easily applied. Complete instructions. Guaranteed materials. Wholesale prices. Complete kits \$12.00 up. Free lists. Ajax Plastics, P.O. Box 1323, Ft. Worth, Texas.

OUTBOARD Rowboat, 14 foot, finest plywood, completely built. Not a kit. Factory to you at 50% saving. Send only \$79.50. Complete, needs only painting. Money back guarantee. United States Boat and Water Ski Co., 722GC East Washington, Los Angeles 21.

BUY Wholesale nationally advertised outboards, thousands other products at big discount. Free "wholesale plan." American Buyers', 628-D Linden, Buffalo 26, N. Y.

100% MARINE Conversions and hardware. Get super deluxe catalog. All photos \$1, refundable with order. Gershel Eng. Co., Oceanside, N. Y.

WATER Skis, 25% savings. New slow speed type (7') for outboards, also speedboats type (6"). Send only \$29.50 pair complete. Money back guarantee. United States Boat and Water Ski Co., 722EC East Washington, Los Angeles 21.

AIR Boat, snow sleigh, propellers, plans, supplies. Catalog 25c. Banks-Maxwell, Box 3301F, Ft. Worth, Texas.

MARINE Varnish. Amazing new formula. Outlasted best varnishes in 18 months actual tests. Elasticity resists cracking. Send only \$5.95 gallon, \$1.95 quart, \$1.25 pint. Money back guarantee. United States Fibreglass and Resin Co., 722FC East Washington, Los Angeles 21.

CONVERT Fords and Jeeps to 100% marine engines with Osco's world famous Convo-Kits. Deluxe catalogue 50c (coin), Oscomotors, 3627B Lawrence, Philadelphia 40, Penna.

BUILD Your own custom 1954 low cost Fiberglass boat. Construction manual \$1.00. United States Fiberglass-Resin Company, 722 East Washington, Los Angeles 21, Calif.

GET Our big 224 page boat hardware and equipment catalog. Send \$1.00 for cost of handling, refunded with first order. Garland Frasher Marine Sales, 2626 Fifth Ave., Huntington, W. Va.

BUILD A 20 foot sailing catamaran. Very fast, stable and fun. Also other boat plans and patterns, power and sail up to 42 feet, literature free. Book "How to Build Boats," \$1.00. Wild Hauber, 2451 18th Ave., No. 1, St. Petersburg, Fla.

FIBERGLAS Permanent boat coating. Maurice Lannon's Fiberglass "How" book—\$2.50. Complete catalog 10c. Airmailed 35c. Gem-O-Lite, Box 6867B, North Hollywood, California.

MARINE Conversions for Ford and Jeep engines. Catalog 10c. Lehman Manufacturing Company, 972D Broad Street, Newark 2, New Jersey.

NEW, Used, rebuilt marine motors. Marine conversions, fittings. Free catalog. Stokes Marine Supply, Dept. 24, Coldwater, Michigan.

BUILD Marine engines with Federal conversion kits. Federal Marine Motors, 9011 Cottage Grove Ave., Chicago 19, Illinois.

FULL Size, cut-to-shape boat patterns, blueprints, 7½-38 feet. New 1954 illustrated "Build a Boat" catalog of 50 naval architect-designed cruisers, runabouts, sloops, skiffs, outboard boats, sailing, racing, houseboats, 25c. Marine hardware catalog, \$1.00. "How to Build Boats" book, \$1.75. PolyWog Houseboat Plans, \$12. Cleveland Boat Blueprint Co., Dept. A-66, 9400 Steinway, Cleveland 4, Ohio.

BUILD Beautiful fiberglass-plastic boats without using molds. New patented method. Write Speedcraft, 2450 Emerson, off Square Lake Road, Pontiac, Michigan.

SPORTING GOODS, GUNS, FISHING TACKLE, ARCHERY, TRAPPING

BARBELLS. Exercise equipment. Courses. Free booklet. Good Barbell Co., Reading, Penna.

CATFISH Blood bait. Can \$1.00 post paid. Harry Beard, Roland, Iowa.

COMMANDO Half-ounce wire pocket-saw for campers, hunters, fishermen, boy-scouts, \$1.00. Colonial Specialties, PM1, Pittsford, N. Y.

MAKE Your own duck and goose decoys. Illustrated catalog 10 cents. Quams, Spicer, Minnesota.

FREE Fishing catalog—123 pages. Over 3000 hard to find fishing specialties. Net-craft Company, Dept. PM3, Toledo 13, Ohio.

CAMPING Equipment, tents, (direct from manufacturer), sleeping bags, air mattresses. Low prices. Free 80 page catalogue. Mor-San Sales, 10-21R 50th Avenue, Long Island City 1, New York.

GUN Wall cabinets. Finished or pre-cut kits. Free leaflets. Johnston Woodworking, Saugerties, N. Y.

HOLLOWGLASS Fishing rods. Save over half. Buy complete kits. Casting, spinning, fly and boat. \$4.95 to \$7.95. Assemble yourself. Full instructions. Makit Rod Company, 429 Fulton, Ft. Worth, Texas.

BUILD A real .22 cal. pistol, just 3" long, with simple tools, complete plans \$2.00. Gun Specialties, Box 392, Sherman, Texas.

SALE! 2000 Guns—Antique, new, used. Big bargain catalog. Rush 50c. Agramonte's, 201 Warburton, Yonkers 2G, N. Y.

IMPORTED Silettes, daggers, throwing, pocket, hunting knives, etc. Free catalog. J. D. Clinton, 94 Church, Mt. Clemens 2, Michigan.

SPINNING Line, flies, wholesale. Special! 150 yards 5 or 6 pound duPont limp spinning line postpaid, \$1.00. Guaranteed. Catalog free. Lee-Dittmar, 553-C Glenwood, Buffalo 8, N. Y.

FREE Copy! "The Archers' Magazine." Request: 1200 Walnut St., Philadelphia 7, Penna.

SAVE 50% On finest bows, arrows, equipment, bowhunting outfits. Free catalog and "How to Hunt with Bow and Arrow" booklet. Send 25c. Malibu Archery, 3156-RJ 8th St., Los Angeles 8, Calif.

BUY Wholesale nationally advertised sporting goods, thousands other products at big discount. Free "wholesale plan." American Buyers', 627-D Linden, Buffalo 16, N. Y.

GUNS, Modern, obsolete, new, used. List 25c. Refundable. Dutz Enterprises, Box 284, Lincoln 5, Ill.

MOLDS For fisherman's sinkers, jigs, squids, casting and spinning lures. Free catalog. Sweet's Molds, Tonawanda 1, New York.

5000 BARGAINS, Firearms, binoculars, war relics. Catalog 50c. Smith Firearms, Runnemeade, N. J.

SHOTGUNS, Rifles, Revolvers, 500 modern, obsolete. Also cartridges. Each list 10c coin. Ed Howe, 52 Main, Coopers Mills, Maine.

CAST Iron molds—For casting fishermen's sinkers. Free illustrated booklet. Reading Instrument Co., Box 78, Reading, Penna.

TAXIDERMISTRY

TAXIDERMISTRY Supplies, books. Everything! Catalog 10c. Vandyke's, Wessington Springs 12, S. Dak.

MODERN Taxidermist Magazine, Greenfield Center 2, N. Y. Devoted entirely to taxidermy, photos, articles, methods. Trial year's subscription, \$1.00.

BINOCULARS, TELESCOPES, MICROSCOPES, MAGNIFIERS

BINOCULARS, Telescopes — Optical goods. Large selection. Sensible prices. Learn truth about binoculars. Coating debunked. Free 38th anniversary catalog. DuMaurier Co., 203C, Elmira, N. Y.

POCKET Compass (German precision). Measures only 3/4" across! Guaranteed! 50c plus 10c postage. United, 9043-C S. Western, Chicago 20.

GIANT Astronomical telescope complete with six ft. tripod. Includes 45X, 75X, 100X eyepieces and sun projector lens. \$15.00. Satisfaction guaranteed. Powerful telescope easily made. Focusing tube, lenses and instructions for making erector. 45X, 100X, 200X and 400X telescope, \$3.75. Suffolk Science, Riverhead 3, N. Y.

BINOCULARS, Telescopes, microscopes. Terrific values, \$3.98 up. Request free money saving catalog. Criterion, Hartford, Conn. Dept. P 21.

WAR Surplus bargains, binoculars, telescopes, sextants, millions of lenses, prisms, reticles, eyepieces, objectives, etc. Mail 10c for big "Catalog CH." Send \$1.00 for Stock CH—10-piece lens kit and big instruction booklet. Edmund Scientific Corp., Barrington, N. J.

GIANT 100X ready to use day and night telescope. Steel and brass tubing construction. Heavy hardwood tripod. Same quality and size lenses as \$15.00 telescope. \$7.95 f.o.b. factory. 400X telescope makers lens kit has brass focusing tube, 5 lenses, erector, instructions. \$3.95 postpaid. Carl Jamer, Manorville, N. Y.

SAVE 25%! Get interesting facts. Free 52 page binocular, telescope catalog, \$3.95 to \$250.00! United, 8043 S. Western, A-7008, Chicago 20. Dealers wanted.

MAKE 6" Telescope reflector. Glass, abrasives, instructions—\$10.50. F. Cameron, Box 65, Inwood 96, N. Y.

AMAZING Prices, binoculars, telescopes, microscopes. Free trial. Folder, "Binocular Selecting," also price lists free. Prentiss Importers, Mercury Bldg., West Los Angeles 25, Calif.

LOWEST Prices, all sizes binoculars, telescopes, microscopes, 8X30 \$32.00. Free catalogue. Joe's Binocular Sales, 4827 Second Blvd., Detroit 1, Michigan.

REFLECTING Telescopes, 60X, completely assembled \$29.75. Guaranteed observatory clearness. Free information. Skyscope, 475 Fifth Avenue, New York 17.

REFLECTOR Telescope kits from \$6.25. All parts designed and built at our Hoboken factory. Mirror cells, diagonals, focusing mounts, tripods, tubing, oculars. Fully guaranteed. Send for free illustrated catalog. Our only sales showroom, Esco Products, 134 West 32 St., Rm. 204-A, New York 1.

PETS—DOGS, BIRDS, RABBITS, HAMSTERS, ETC.

NATURALIST'S Catalog 10c. Chameleon 85c. Hamsters \$2.75 pair. 200 mealworms \$1.20. Quivira Specialties, Topeka 51, Kansas.

GUINEA Pigs—Wonderful enterprise. Booklet free. 426A, Hapeville, Georgia.

START Right by knowing facts about rabbit raising. Illustrated booklet describing all breeds, housing, feeding, breeding, marketing. 48 pages 10 cents. American Rabbit Breeders Association, 36 ARBA Building, Pittsburgh, Penna.

RABBITS—Wonderful home enterprise. Booklet free. Tayco Rabbitry, Hapeville, Georgia.

BEAUTIFUL Pure white pedigreed police puppies. Ansonia Kennels, Mose, N. Dak.

EARTHWORM Raising pays worthwhile profits! Illustrated booklet explains raising, feeding, packing, marketing. 25c. Ozark Worm Farm—J. Willow Springs, Mo.

ST. Bernards, Boxers, Hof Kennels, 5136 Cascade Rd. S.E., Grand Rapids 6, Mich.

ANGORAS, Chinchillas, White Giants! World's most profitable rabbits! Catalog free. Grinstead's, Edwardsville, Illinois.

PREFAB Dog houses. Free catalog. Webb Company, 184-CPM, Drexel, Mo.

HAMSTERS—Fine small pets. Send 10c for folder or \$1.00 for complete hamster manual. Anderson's Hamstery, 35 Oneida, Pontiac, Michigan.

CHINCHILLAS Book, breeding and care. Ludwig Ranch, Mohnton 10, Penna.

CHINCHILLAS Rented, offspring bought. R. Rau, Route 2, Jeannette, Pennsylvania.

CHINCHILLAS—Unbelievable price. Free literature. Par-West Chinchilla, 1446A Jones, San Francisco 9, Calif.

WE Raise chinchillas in our basement. Very profitable sideline. Write for brochure. Merrill Hendrickson, Franklin, Ind.

HOW To raise waiting mice 25c. S. E. Keegan, 7855 Mill Road, Philadelphia 17, Penna.

DUCKS, Geese, guinea, 12 most popular varieties; also 50 purebreds and cross-breeds baby chicks. Gorgeous poultry book free. Berry's Farm, Route 12, Clarinda, Ia.

STANDARD Rabbit Journal, Milton 3, Penna. Year \$1.00. Sample dime. Beginners manual 25c.

WHITE German Shepherd puppies. Theatrical dog tricks. Knoff, Pewaukee, Wisconsin.

HAMSTERS—Golden; young, \$4.00 pair; fully developed, \$5.00 pair. Request prices on rare albinos. Adirondack Hamstery, Prospect 2, New York.

RAISE Rabbits. Make money. Send 25 cents for market information, housing plans, prices for starting stock. A. Johnson, Box 694, Kansas City, Mo.

GROW Mushrooms, Cellar, shed, and outdoors. Spare, full time, year round. We pay \$3.50 lb. We paid Babbit \$4,163.00 in few weeks. Free book. Washington Mushroom Ind., Dept. 171, 2954 Admiral Way, Seattle, Washington.

CHINCHILLAS—Pedigreed South American. Use spare room or cellar. No odors. Profitable. Stewart Chinchilla Ranch, Washingtonville, N. Y.

1000 BRED Mink booklet, plans 20c. Lake Ontario Ranch, Gravel Road, Webster, N. Y.

FOR Sale: A few outstanding Coon-hounds, Beagle, and Rabbithounds. Prices from \$15.00 to \$40.00. Free literature. Trial. Dures Thomas, Box 268, Albertville, Alabama.

HAMSTERS—Cages and equipment. Free illustrated details. Lakeview Hamster Colony, Newfield, New Jersey.

MAKE Big money! Raise Chinchilla rabbits. Cash markets supplied. Write today! Rockhill Ranch, Sellersville 15, Penna.

MINK Raising information free. Complete. Lake Superior Mink Farm, Superior, EEL, Wisconsin.

CHINCHILLAS (No rabbit.) Easily raised anywhere. Profitable. Big future. Terms. Hibner Chinchillas, Ithaca, Mich.

RAISE Highly-profitable Angora and New Zealand rabbits. Particulars free. White's Rabbitry, Jackson, Michigan.

RAISE Mink; Free booklet, pen plans, inside secrets, feed, care. Mink are money makers. Investigate today. Lawrence Mould, Brigham City 12, Utah.

PLANTS, SEEDS, NURSERY AND GARDEN SUPPLIES

GLADIOLUS, Hundred blooming size postpaid \$1.89. Gladhaven, Sebastopol, California.

BASEMENT Window greenhouse plans. Complete for early planting. \$1.00. Jays, 2112 Portland, Minneapolis.

GROW Christmas trees. Ornamental landscape evergreens. Profitable. Quality planting stock at wholesale on quantity. Free list. Planting guide. Suncrest Evergreen Nurseries, Dept. PM, Johnstown, Penna.

GINSENG, Goldenseal roots bring \$2-\$12 pound. Full information. F. M. Collins, Viola, Iowa.

MULTIFLORA Rose, the living self-repairing fence, ornament, erosion control, windbreak, snow fence, etc. Rapid grower. Raise from seed. Free planting guide, write Woodlot Seed Company, Norway 4, Michigan.

FARMS, FARM LANDS, REAL ESTATE

FLORIDA—Beautiful retirement homesites near gulf coast. Excellent hunting, fishing in 9 fresh and salt water rivers. 11 bays and gulf. \$250 at \$10 monthly. Free literature. V. M. Mathews, Box 1406, Asheville, N. C.

NEW Strout catalog, just out! Farms, homes, businesses, 34 states, coast-to-coast, over 3000 bargains described. Mailed free. World's largest; 54 years service. Strout Realty, 7-M So. Dearborn St., Chicago 3, Ill.

FREE Ozark farm list with actual photos, Owensby, Buffalo, Missouri.

SELLING Lakeview home, garden, like rent. Details. Perry, Briarhill, Penna.

REAL Estate (any kind) bought, sold, traded anywhere. Free information. Toole's, Box 34, Evansville, Indiana.

FLORIDA—Homesites, business sites and acreage in Potterfields Garden Acres. High dry land about 40 miles from Tampa and St. Petersburg. Close to wonderful hunting and fishing. Tracts as low as \$595.00 for three acres, only \$10.00 down, \$10.00 month. Information write G. B. Potterfield, Owner, Dept. V, Charleston, W. Va.

POOR Man's chance—\$5.00 monthly buys 40 acres productive land; near town; price \$200. Free list. Box 423-P, Carthage, Mo.

DO You want to buy or sell property? Write National Property Advertising Agency, P.O. Box 633, Sheboygan, Wisconsin.

FARM And business catalog free! Big edition. Hundreds of bargains from \$1000 up. Maine to Florida. West's, M-3, Pittsburgh 17, Penna.

CANADIAN Tax sale lands for three dollars an acre and up. Small monthly payments. Farms, timber, hunting and fishing camps, minerals. Limited number of properties. Write at once for free catalogue. Tax Sale Service, Room 105, 120 Bloor St., W., Toronto 5, Canada.

COME To Houston now. Get your delightful home here in popular suburbs of America's fastest growing city. Choice homesites only \$345—payable \$15 monthly. Excellent water. Splendid soil. Grow oranges, berries, vegetables, poultry. Many concerns here need more employees at good pay. Free booklet. Preston Wood, Box 413, Houston, Texas.

GET Ozark property sales lists free. Address Armstrong, Shook, Missouri.

FARM-Ranch opportunities. Favorable conditions. Washington, Minnesota, Montana, Idaho, Oregon, North Dakota. Literature, farm descriptions. Specify which state. J. W. Haw, 119 Northern Pacific Ry., St. Paul 1, Minn.

FLORIDA'S Choice lakefront lots. Eustis-DeLand highway. \$10 monthly without interest. Free literature. Roepke, Eustis, Florida.

FLORIDA—New development adjoining Ocala National Forest in Lake County. Best fishing, hunting. Nice homesites \$245 at \$10 monthly. Folder free. Howard Vernor, DeLand, Florida.

HOMESITES \$400—Convenient payments. California's finest garden section. On Morro Bay's scenic shores. Wonderful fishing, boating, bathing. Fertile soil, softest water, temperate climate, congenial community. Free literature. Richard Otto, Department M, San Luis Obispo, Calif.

FLORIDA Choice lakefront lots available. Best fishing, hunting. Terms. Grace Parker, Paisley, Florida.

POULTRY, FARM SUPPLIES

CONSTRUCT Animal cages easily with our clips and pliers. Dealers wanted. Sterling Mfg. Co., 1791 Pine Street, Napa, Calif.

BARRED Rocks or N. H. Reds \$7.95 per 100. Your choice. National Chicks, Philadelphia, Penna.

RAISE Turkeys the new way. Write for free information explaining how to make up to \$3000 in your own backyard. Address—National Turkey Institute, Dept. 3, Columbus, Kansas.

PROFITABLE OCCUPATIONS

FOREIGN Jobs, \$2.00. Tells how, where apply, 60 countries. Choose country and profession. Oil, construction, steel. Information Service, 8902, South San Francisco, California.

SPECIAL Copyrighted reports! Who to contact for highest paying jobs in 42 countries, including U. S., Alaska, Spain, South and Central America, Europe, etc. Listings of employers with contracts who hire skilled, unskilled, professional, supervisory, clerical, laborers, trades, many others. Many average \$1550.00 monthly. Also best oil, aviation, manufacturing opportunities. All for only \$2 (c.o.d.'s accepted). Includes one year registration and advisory service. Application blanks. Only service with unconditional money-back guarantee of satisfaction. Write or wire today. Reports airmailed. International Reporter, Box 1047-PA, St. Louis 1, Missouri.

SEND For big, new 1954 illustrated catalog that will show you how to turn your spare time into cash—making quick-selling, highly profitable lamps. Every home a prospect. Hundreds doing it, you can, too. No experience or special tools required. Catalog No. 7 contains 56 pages filled with shades, shade frames, figurines and bases, oil lamp converters, boring compound, and dozens of similar items. Also all kinds of sockets, cords, pipes, harps, finials, bases, and hundreds of other parts—everything you need. Special 8-page section shows 6 beautiful lamps in kit form, ready to assemble. You buy wholesale, sell at retail. Make big profits. Send 25c today for new 1954 catalog and wholesale price list, you'll be glad you did. The 25c will be refunded on your first order. Gearon Co., Dept. 500-B3, 27 S. Desplaines, Chicago 6, Ill.

AMAZING Profits rebuilding windshield wipers. Details, sample kit \$1. Refundable first order. Hardy's Service, 878 East Waterloo Road, Akron 19, Ohio.

WANT A diesel job? New opportunities to increase income. Higher pay. More money. We can help you qualify. Toos. Shop method home training. Write today! Diesel, Tractor, Heavy Equipment Division, Interstate Training Service, Dept. B3C, Portland 13, Oregon.

NEED More money to live on? Increase your weekly income \$20 to \$25 or more in spare time. Supply Rawleigh Products to consumers. Also openings for full-time dealers. Write Rawleigh's, Dept. C-DD-PPM, Freeport, Ill.

"HOW To Make Money With Simple Cartoons"—A book everyone who likes to draw should have. It is free; no obligation. Simply address Cartoonists' Exchange, Dept. 93CP, Pleasant Hill, Ohio.

SAIL HO! Merchant Marine employment opportunities, complete information, \$1.98. Satisfaction guaranteed. Seaways, Box 1231M, Baltimore 3, Maryland.

\$10,000 PROFITS! Your own mailorder business! No risk! Success plan free! Treasury, 709 Webster, New Rochelle L-21, N. Y.

\$1300.00 MONTHLY For truck drivers, \$1400.00 monthly for carpenters, electricians, plumbers, mechanics, \$1200.00 for clerks and laborers. Now hiring in this vicinity. Full information and complete foreign listings, with current information on Spain job, \$1.00. Women's listings, \$1.00. 25,000 men and women needed for new statewide project! Complete information and other domestic listings, \$1.00. Dept. 3-C, Opportunities Unlimited, 1110 Commerce Bldg., St. Paul, Minn.

ASTOUNDING Profits raising jumbo frogs. Free pamphlet. Brolo Frog Farm, West Frankfort, Ill.

TYPISTS—Profitable home business. Complete copyrighted information, 50c. Gaunt, 827-W Irving Park, Chicago, Ill.

MAKE Money breeding rare waiting mice spare time. \$5.95 starts you. Get particulars. They act like crazy. S. E. Keegan, 7855 Mill Road, Philadelphia 17, Penna.

HOME Mail order beginners instruction handbook, 25c, stamps—coin. Carnahan Bros., 5562-A Nelson, Cypress, Calif.

SELL Popular Mechanics and all other magazine subscriptions. Free catalog, supplies. Subscription Service Company, Dept. B, P.O. Box 3070, Birmingham, Alabama.

MAKE Flexible molds. Cast figurines, plaques. Free sample. Tooker, 630-M Chestnut, Hamilton, Ohio.

MUSHROOMS Grown boxes, barrels. Manureless process 50c. Spawna \$1.00. Gordons, 553 William, Winnipeg, Manitoba.

SOUTHERN California is booming! Grow with it. Get big job and opportunity report showing job openings, business opportunities, actual companies now hiring, pay scales, living conditions, etc. For accurate, last-minute information about this fabulous area, send \$1.00 to Tower Distributors, Dept. 405, 15136 Vermont, Paramount, Calif.

BECOME A mortgage broker, unlimited field. Eagle Co., 3215 Collingwood, Detroit, Mich.

MEN Wanted for jobs on foreign, Latin America and far North projects. Truck drivers, \$3.55 hour. Electricians, \$4.00 hour. Carpenters, \$3.70 hour. Laborers, \$3.00 hour. Clerks, \$3.00 hour. Most all trades wanted. Up to 70 hour week with time and one half for all over 40 hours. Transportation paid. 8 to 24 month contract. Full information of all firms hiring, living conditions, family accommodation, wages, hours, age, contract requirements, application form, etc., \$1.00. Air mail \$1.24. Edward O. Burns, 2515 Alden Street, Dept. 6, Dallas 11, Texas.

FLORIDA Jobs. Florida needs you. Live and work on the fabulous gold coast. Hundreds of good jobs for skilled and unskilled men and women. For information send your name, address and \$1 to Florida Personnel Institute, Dept. A, Box 4821, Miami 31, Florida.

MEN Wanted. Build luggage and cases at home. We sell your products—Complete instructions. No special equipment needed. Free details. Cascraft, 805-D1 Sunset Blvd., Los Angeles.

FOREIGN Employment construction work. If interested in foreign projects with high pay write Foreign Service Bureau, Dept. P.M., Metuchen, New Jersey.

SET Rhinestones in plated backs. Easy. Over 100% profit. Catalog 20c. Bergen Arts, 128M Main Street, Hackensack, N. J.

WELDING Pays big money. Learn easily at best equipped school in country. Non-profit school with low cost training. G.I. approved. Write Hobart Trade School, Box M-342, Troy, Ohio.

FOREIGN Employment. U.S. companies need personnel. Now! Immediate information, listings, applications from leading job information bureau. \$1.00. Additional free information on booming Brazil, California, Florida, Hawaii, etc. Box 271B, Worldwide Job News, Temple City, California.

FREE! "301 Profitable Small Businesses!" Amazing shoestring plans! Work home! Start anytime! Deumant Surveys, Kenmore 23-PM, N. Y.

\$10.00 HOURLY Possible making ladies' jewelry. Some make more. Start now. Send \$1.98 for profusely illustrated book showing how. Lapidary, Wenona, Illinois.

CONSTRUCTION Job list. Published monthly. \$1.00. Dempster's Construction Scout News, Dept. 268-YZ, Bridgeport, Ill.

FOREIGN Jobs. Contracts underway and soon starting in Africa, South America, Canada, England, Europe, South Pacific, Middle East, Mexico and Alaska. Send \$1.00 for foreign job news, information, application forms, etc. DCS Foreign Job News, Dept. 268-TQ, Bridgeport, Ill.

ALASKA, Last frontier. Get facts, not misinformation. Up to date, on the spot information on construction, labor, business, living and housing conditions, home-steading, climate, etc. Airmailed \$1.50. Alaska Research & Information Service, Box 823, Anchorage, Alaska.

GERMAN Manufacturers list \$1.00. American representatives wanted. Details. Burke Associates, Manchester 1, Mass.

BUY Wholesale thousands nationally advertised products at big discount. Free "wholesale plan." American Buyers', 628-P Linden, Buffalo, N. Y.

LATEST information! Top paying jobs. Foreign-domestic. Construction, oil, aviation, manufacturing. Write Universal Services, Box 14-21, Clayton 5, Missouri.

FOREIGN And domestic jobs. High pay to \$14,000.00. Fare paid. Alaska, South America, United States, etc. Stamped self-addressed envelope, brings reply. Foreign Opportunities, 1M, Waseca, Minn.

EVERYBODY Likes candy. Learn to make professionally. Our 44th year. Ragsdale Candies, D6, East Orange, New Jersey.

RAISE Pheasants on \$100 week plan. Little capital and space can make you independent. Free details. Great Central System, Columbus 1, Kansas.

FOREIGN, Latin American, domestic employment. 1954 "Foreign Service Directory" originator of job news by copyright, gives up-to-minute facts on military and civilian construction; Canadian, Alaska construction; major oil companies; aviation; manufacturers; steamship lines; mining; importers-exporters; how-when-where to apply with application form. Free—Hot list firms hiring, \$1.00 postpaid. Global Reports, Box 883-P, Hollywood 28, Calif.

LEARN Metalizing baby shoes, gifts, etc. Bronze, gold, silver. Folio free. Kiktavi, 7217-MK South Broadway, Los Angeles 3.

HONOLULU Help wanted columns airmailed \$1.00. Sterling's, #3 Campbell Block, Honolulu, Hawaii.

ALASKA! Last American frontier. \$1.00 brings 1954 business directory and government map. Military and civilian construction; homestead and highway facts; mining, aviation, fur farming, grazing, timber, travel directions. List of firms hiring. How to apply. Alaska Opportunist, Box 92-P, Hollywood 28, Calif.

OVERSEAS: Contracting, engineering and oil companies; big pay, no U.S. taxes, cheap living costs. Send \$1 for list showing where to apply. ForeignJobs, Box 165, Washington 4, D. C.

ALASKAN Jobs! Over 150 new construction projects with names, addresses companies hiring. Thousands needed. Highest wages. Military, private construction, mining, fishing, lumbering, aviation, railroads, homesteading. Skilled, unskilled workers. Salary information. Alaskan map included. \$1.00 complete. Alaskan Opportunities (PM), Box 362, Kenmore, Washington.

GROW Mushrooms. Cellar, shed, and outdoors. Spare, full time, year round. We pay \$3.50 lb. We paid Babbitt \$4,185 in few weeks. Free book. Washington Mushroom Ind., Dept. 99, 2954 Admiral Way, Seattle, Wash.

JOBS On ships and yachts, excellent pay. Foreign travel. Davenport's, Dept. 3, Box 1354, G.P.O., New York 1, N. Y.

BE The Popular Mechanics representative in your neighborhood and earn big profits in your spare time. Write Popular Mechanics Magazine, Room 408M, 200 E. Ontario St., Chicago, Ill.

FREE Book "505 Odd, Successful Businesses." Work home. Expect something odd! Pacific, Oceanside, Calif.

BOOKS, PERIODICALS, PICTURES, POSTCARDS

PICTURE Post cards from your photograph. 1000, \$11.00. Raum's, 4154 Fifth Street, Philadelphia 40.

FREE Samples. Many 10c items. Walter Mondschlein, Box 222, Chicago 90.

BOOKS, Government surplus. Career books for enterprising youth. Bargain prices. Free catalog. Long's College Book Co., Dept. PM, Columbus 1, Ohio.

WORLD'S Smallest Bible 50c. Three, \$1.00. Empires, Box 301, Amesbury, Mass.

BIBLES, Devotional, inspirational books. Catalog free. The Mail Order Bookstore, 1326 SW. Hall St., Portland, Oregon.

ARTCRAFT Books. Half price. Catalog 10 cents. Artcraft, Baldwin, Maryland.

BOOKHUNTERS! Scarce, unusual, miscellaneous books supplied. Atlantic Book Service, Cedar Street, Charlestown 29, Massachusetts.

SPARETIME Profits taking subscriptions, all magazines. Wholesale catalog free. Cassell Agency, Westfield 2, New Jersey.

BOOKHUNTERS! Unusual, scarce, gay, serious miscellaneous books. Catalog free. The Mail Order Bookstore, 1326 S.W. Hall St., Portland, Oregon.

BOOKS Found! Any author, old or new. Rush titles wanted; no obligation. International Bookfinders, Box 3003-PM, Beverly Hills, California.

NATIONAL Geographic Magazines, 1888-1952. Periodical Service, Box 465-PM, Wilmington, Delaware.

BOOKHUNTERS! All subjects. Send wants! Jaher Book Service, 620-P East 178 Street, New York 57.

GAMES, TOYS, NOVELTIES

2 MINIATURE Electric motors \$1. Runs 6,000 r.p.m. on dry battery. Easy-to-build kit, instructions. Loyal Co., Massillon, R2PM, Ohio.

MAGIC TRICKS, PUZZLES, JOKER NOVELTIES

FAMED Entertainer's guaranteed professional starting lesson \$1. Maxam Magic, St. Albans, Vt.

JUMBO Catalogue! Tricks! Puzzles! Funmakers! 10c. Rick's, Box P250, Chicago 90.

VENTRILOQUISM Selftaught. Quick, easy lessons, 25c. Dummies. Ventriloquist, Calallen, Texas.

FREE Magic and novelty catalog, includes 14 wonderful magic tricks fully illustrated and described. Send only 10c to cover cost of mailing. Read all about our free gift offer. Chicago Magic Center, 19 W. Randolph St., Chicago 1, Ill.

FREE Catalog. Best magic, practical jokes. Top Hat Magic, Evanston, Illinois.

BE A magician. Large professional magic catalog of latest tricks, 35c. Ireland, C-109 North Dearborn, Chicago 2.

NEW Magic folder now ready. Rush name. Alruth, Box 478-PM, Denver, Colo.

WOODEN Nickels, catalog, trick, 25c. Fun'n Magic, 423-P North St. Marys, San Antonio 5, Texas.

REAR View mirror attachment for glasses. Free details and gift. Starling Co., 2206M Starling Ave., New York City 62.

WE Supply every noted magician. Large professional catalog \$1.25. Holden's, 120 Boylston Street, Boston, Mass.

500 TRICKS, Douglas famous 120-page catalog, only 10c. Fastest service to magicians for 30 years. Send 10c today. Douglas Magicland, Dept. 1, Dallas, Texas.

2500 TRICK Catalogue (512-pages), pocket, parlor, stage. World's finest magic. Catalogue \$2.00 (dollar trick included free). Kanter's, M-1311 Walnut, Philadelphia 7.

90 PAGE Novelty-magic catalog with novelty, 25c. Allen, Dept. PMT, Clinton, Missouri.

PROFESSIONAL Catalog, 175 pages, 25c. Williams, 900 Plymouth, Ellwood City, Penna.

ENTERTAIN With magic—Hobby or profession. Write Marsh's, 237 W. 11th, Columbus, Ohio.

STAMP COLLECTING

DIFFERENT, 500, 50c; 1000, \$1.00; 2000, \$2.75; 5000, \$11.00. Approvals. K. S. Holmes, London, Canada.

UNITED States commemoratives. Large, 100 different, \$1.00. Postal and revenue approvals. Altapa, 2624-C North Albany, Chicago 47.

MINIATURE Sheet free if you request approvals. Lee Hoover, Box 3594, Portland 8, Oregon.

FREE! Triangle collection 17 different picturing sports, flowers, airmails, multi-colored birds, plus stamp encyclopedia. Send 10c for handling. Bargain approvals included. Stampex, 116-UM Nassau Street, New York City.

FREE Complete set of famous Americans, flags, parks and presidentials to approval buyers. Send 5c for 15 of the above stamps plus full particulars. Triboro Stamp Company, 145 Nassau Street, Dept. 103, New York 38, N. Y.

PLEASURE Is yours for pennies when you select from our big books of 1000 stamps. Clean and neatly arranged stamps for your selection. Scott's catalog number and price under each stamp, but large discounts allowed. Write today and watch your collection grow. Wolverine Stamp Service, Dept. A-22, Fruitport, Mich.

AMAZING Rare bargain—Finest pictorial collection. 40 world religions, 25 battle scenes, 25 world maps, 25 famous personages, 20 art and artists, 20 ships, 18 South Sea Islands, 10 locomotives; totaling 183 pictorial stamps. Biggest illustrated selection plus 100 worldwide, all for \$1.00. Only to adults requesting approvals. Canada Stamp Co., 1907 Main St., Dept. 218, Niagara Falls, N. Y.

FREE! Rare colorful San Marino's Columbus pictorial set. With bargainful approvals. PG. 304 Bates, Lewiston, Maine.

77 DIFFERENT United States 25c. Approvals. Utechs, 1143D North Keeler, Chicago 51.

INDONESIA—10 Mint bicolored dazzling pictorials, just 5c to introduce our famous approvals. Viking, 11-Z Northern Blvd., Great Neck, N. Y.

COLONIAL Collection free—Magnificarous collection, British, French, American and other colonies. Flowers, animals, commemoratives, triangles, pictorials, high values all free plus Philatelic Magazine. Send 5c for postage. Empire Stamp Company, Dept. PM, Toronto, Canada.

PICTORIAL, Angola, Mozambique, Hungary, a fine assortment of stamps, 3 different sets depicting wildlife in natural colors, plus 100 attractive stamps, 10c to approval applicants. Modern Stamp Co., Dept. A-6, Ferrysburg, Mich.

PAYING High prices for approvals? If your collection numbers under 15,000 try our 1c and 2c approvals. In books of 1,000. Special offer to customers. U. S. also available. Clark Stamp Co., Dept. A-42, Muskegon Heights, Mich.

HANDSOME New Zealand 1943 Elizabeth and Margaret Rose triangles only 10c to approval applicants. George Richie, 1539 Sixth, Alameda, Calif.

500 DIFFERENT Attractive stamps, a special assortment worth many dollars, from Macau, Ruanda-Urundi, Congo, Monaco, Vatican, Angola, Mozambique, etc. Entire collection only 50c to approval applicants—U. S. or foreign. Roseland Stamp Co., Dept. A-32, Spring Lake, Mich.

SENSATIONAL! Gift yours free. It's terrific! Amazing collection. Write now. Drakeco, 4415 Troy Street, Chicago 32.

ALBUM, 300 Stamps, premiums—25c. Smithco, Northeast 6818, Kansas City 23, Mo.

DEALERS—Wholesale list. Postage 3c. Frank, 5031 Queensberry, Baltimore 15, Maryland.

5 TRIANGLES 2c with approvals. Choice Stampco, P.O. Box 424, Miami 3, Florida.

12,000 PENNY Approvals waiting for you. Many from exotic countries, pictorials, airmails, new issues. Tilbury, Box 862, Newark 1, N. J.

25 BRITISH Colonies 10c. Approvals. Stoll, 2632 Burnett, Louisville 10, Ky.

10 MINT Sets, 20c to approval applicants. Shere's Stamp Supply, Byron, Ill.

25 NEWFOUNDLAND 25c With approvals. Woodside, 23 Thorndale, Hamilton, Ontario.

500 DIFFERENT 25c. New customers. Wilcox, Box 282, Bremerton, Wash.

MINT U. S. commemoratives and topical packets. List, Charles Hendricks, 506 Bennington, Youngstown 6, Ohio.

HIGH Grade approvals. U. S. and foreign. Schenck, 1650 Ocean Parkway, Brooklyn 23, N. Y.

NO Rareties, no junk, just good solid approvals for serious collectors. Dominion Stamp Company, Arlington, Va.

SENSATIONAL! Ten sets 10c. Approvals. V-Ann, G.P.O. 671-P, Brooklyn 1, New York.

10 DIAMOND Shaped stamps, 5c to new approval applicants. Moulblow, Box 278R, East Northport, N. Y.

FREE! Pictorials, stamp packet, approvals. Pegram, Box 783, Huntington Park, Calif.

FREE U.S. or foreign packet, Rothberg, 44 Bromfield, Boston 8, Mass.

FREE Valuable stamp packet, approvals. Pless, 1495-P Montgomery, New York 53, N. Y.

VALUABLE Offers for free appraisal. Free gift. Dollar Stamps, Box 249, Blackfoot, Idaho.

FREE Packet, United States and foreign approvals sent. Hoyt, Lowell Rd., Hudson, New Hampshire.

UNITED States collection disposal at 1943 catalog prices. George Sloat, Bogota, New Jersey.

SUPERIOR Worldwide mission mixture. Amazing variety! Five ounces \$1.00. Bay Nielsen, 4407B Catherine, Montreal 6, Canada.

WOW! 133 All different Germany, 10c. Zeppelins, semi-postals, airmails, high values, big bargain lists and approvals included. Jamestown Stamp, Jamestown 512, New York.

CIPEX Souvenir sheet plus 25 different U.S., 10c. Approvals accompany. Village Stamps, 90-39P 214 St., Queens Village 28, N. Y.

FREE, Greek airmail set with approvals. Stanley Bazan, 801 Literary Road, Cleveland 13, Ohio.

51 DIFFERENT From 51 countries, 10 cents. Schmidlin, Dept. PM, Russiaville, Indiana.

SENSATIONAL Clearance bargain lists sent free. Beacon Sales, Maynard, Mass.

ISRAEL, 25 different for only 25c. Approvals accompany. Dresel, Box 270-L, New York 25, N. Y.

50 DIFF. Uruguay 10c to approval applicants. Eloc Stamp Co., 682 Pearl St., Benton Harbor, Mich.

100 DIFFERENT U.S. commems. 50c! 2,000 world \$3; 3,000 \$6; 5,000 \$15; 10,000 \$45! Money saving catalog free! Stamp-by-Mail, 2133 Lunt, Chicago 45.

FREE Angola animals, approvals. Gannon, 703 E. Artesia, Long Beach 5, Calif.

LET'S Trade—Send 100 foreign stamps, dime and stamped envelope for 100 of mine. George Sloat, Bogota, New Jersey.

RICH U.S. mixture \$1.00 pound. Approvals. Bewley, Box 3194, Fort Worth 5, Texas.

FREE Illustrated bargain lists. San Francisco Stamp Co., Box 1805, San Francisco, Calif.

SURPRISE Mixture—7 ozs. foreign \$1; U. S. 50c. Howard Nichols, York, Canton, Mass.

FREE 106 Foreign stamps to approval applicants. Many Lands Stamps Co., Minneapolis 8, Minn.

REQUEST Approvals and receive Lundy Is. sheet free. Elmont Stamp Co., 71 W. 35 St., New York 1.

SPECIAL Introductory offer! To acquaint you with our better U. S. approvals, you get 2 different \$5.00 U. S. stamps plus 20 others; HI-values. Air-mails. Commemoratives, etc. Send 10c for Lot 50. Irwin Stamp Co., Box 12, Brooklyn 29, N. Y.

WORLDWIDE Bargain approvals. Free gift. Mange, Box 6, Hanover, Penna.

HONDURAS. Most issues prior to 1935, also hard-to-get Central, South American, large discount imperfects. Niemeier, 2216 Bayard, St. Paul.

PORTUGUESE Colonies missionary bi-colors. Free to approval buyers. Pleasure Stamps, 1865P-42nd, Brooklyn 4, N. Y.

SENSATIONAL U.S., Confederate States catalogue free. Stone's, 43 Bromfield, Boston 8, Mass.

APPROVAL Buyers can receive late issues free. Details, Wilvanan Stamps, Box 472J, Slatersville, R. I.

OLD U. S. approvals. Low prices. MacG., 2905 Observatory, Cincinnati 8, Ohio.

UNITED Nations cover free to applicants of U. S. or British Colonial approvals. A. Taylor, Skyland, N. C.

1000 FINE Mixed U. S. stamps, 25c. Wright, 723 Washington, Hagerstown, Md.

200 CHINA 55c; 25 Chile airm 75c; 150 Cuba \$2.50; 100 Uruguay 65c; 500 France \$4.25; world 5000, \$12.50; 10,000 mounted \$41.00. Mammoth list sent. Econopackets, Box 168, Riverside 9, Calif.

100 BRITISH Empire 10c. Approvals. Sadler, 9013 Central, Kansas City 14, Mo.

U. S. Illustrated price list free. Lush, 6422 Ellsworth, Detroit, Michigan.

850 MIXED U. S. old, new, 25c. Lists. Weatherby, Medina, Ohio.

"WHAT Every Collector Should Know." Buy your stamps for same prices dealers pay. Also learn secret how dealers operate business from home. Write for copy, "Stamp Dealers' Secrets." Bargain price list included. Send 10c to cover handling. Wholesale Stamp Company, Jefferson Valley 6, N. Y.

MONACO Nudes 10c with approvals. Royal Stamp Company, Tamaqua, Penna.

U.S. Mint specials Flag set, complete, \$1.00; 1928 Hawaii set, \$1.50. Free list. Brooks, 2352A East 23rd Street, Brooklyn 29, New York.

STRETCH Your stamp budget! Revealing information, big money-saving "Stamps in Quantity" catalog free! Send today! Tower, 1630 Melrose, Chicago 13.

FREE! \$10.00 Airmail! Canadians! Colonials! Commemoratives! Approvals. Keating, 2520 Boulevard, Jersey City, N. J.

U.S. Commemorative lists and packet 10c. Robert Gallup, Albany 1, New York.

DAZZLING Triangles, gorgeous bicolored pictorials, famous men, battlements, airmails, unused, 3c to approval buyers. Fortune Stamps, PMM-1, Washington 10, D. C.

\$10.00 WORTH Armenia, Jugoslavia, France, etc. \$1. Fuld, 541 East 182nd, Bronx 57, N. Y.

FREE, U.S. \$1.00, German peace issue. Approvals. Bala Stamps, Bala-Cynwyd, Penna.

300 DIFFERENT Given free with approvals. Particulars. Windsor Stamps, 8834 South Cornell Ave., Chicago 17.

FREE \$7.00 International album to regular customers foreign approvals. Hal Buck, 935 Waterloo, Stockton, California.

STAMP Wallet 3c with approvals. Am-burgs, 537U 35th, Union City, N. J.

U.S. 75 Different, 10c. Approvals. Farmer, 4913 Rosewood, Los Angeles 4, Calif.

AIRMAILS On approval! Brooks, 2352P East 23rd Street, Brooklyn 29, New York.

5000 DIFFERENT Worldwide \$9.50. Max Kaplan, Box 115B, Hollis 23, N. Y.

PENNY Approvals by country. M. H. Hoerning, 15, Farmington, Ark.

14,000 DIFFERENT Yours on our streamlined systematic club plan for only 50c weekly. Big shipment every two weeks. Details free. Sloquist, Box 217, Valley Stream 75, New York.

UNITED States commemorative price list free. James Cunningham, 101 Terrace, Hasbrouck Heights, N. J.

FIRST U. N. set among world's prettiest. Only 10c. Approvals. Welles, 1246-R Church Street Station, New York City 8.

BARGAINS Galore. Low priced approvals. Schur, Box 345, Buffalo 12, N. Y.

STAMPS Wanted. Mint and used, collections, accumulations. Good grades only. Buy outright if bargain. What have you? Write, give details. Vanroy Shirk, Lebanon, Penna.

FREE Surprise packet with approvals. Fahsing, Dept. PM, Atascadero, Calif.

UNITED States price list 100 pages, hundreds of illustrations, stamp identification 10c. Thom, 4808-15 Ave., Minneapolis 17, Minn.

FREE! Big United States catalog. Valuable guide and check list. Hundreds of illustrations. Approvals. Harrisco, 217 Transit Building, Boston 17, Mass.

GIANT Approvals. Thousands different, at 1 and 2c. Wahl's Stamp Exchange, 7008P Farragut, Chicago 31, Ill.

FREE! Big United States catalog. Just published by world's largest stamp firm. Hundreds of illustrations. Lists United States postage stamps complete; big values in United States and foreign packets; amazing clearance sale bargains; beginner's kits; special offers; valuable information. Approvals included. Harrisco, 226 Transit Building, Boston 17, Mass.

TRIANGLES, Birds, butterflies, flowers—Big packet 10c with approvals. Southwest Stamps, Box 117, Long Beach 1, Calif.

300 DIFFERENT, Triangle, airmail, pictorials, etc. 25c. 500 mixed U. S. 25c. Carlton's, Tujunga, Calif.

88 FLAGS in color. All nations, 10c to approval buyers. Potomac Stamps, Washington 15, D. C.

60,000 DIFFERENT—On approval! Books, world-wide. Cole, 43-A Rinevalt, Buffalo 21, N. Y.

STAMP Collectors collect foreign stamped envelopes. Correspond in over 65 countries. Costs you 11c per remail. Details \$1. Kornafel, Box 370, Harvey, Ill.

FISHERMAN'S Treasure set of lovely mint Mozambique stamps. Each with tropical fish in brilliant natural colors. Only 5c. Approvals. Hathaway, Box 145PM, Garden City, N. Y.

SPEND Pennies! Not dollars! Thousands of fascinating stamps to choose from our 1c and 2c approvals. No premiums. Just honest value! Pat Knowles, 3903 Van Nuys, Van Nuys, California.

PROFITABLE Surprise: Asia, 111 diff. 20c. China, Hejaz, Israel, Japan, Manchukuo, Siam, Robert Boger, 3401 Oakmont Ave., Philadelphia 36, Penna.

BUSINESS And professional men! For the better U.S. approvals, write, New-Way Stamp, Lawrence 6, Mass.

FREE Valuable mystery gift. Approvals. Raymax, 37-2 Maiden Lane, New York City 8.

POLAR Bear triangle, giant George Washington, six colored Ecuador, Arctic triangle, first American commemorative, Corsica, Devils Island, others. Everything free with approvals. Capital Stamps, Little Rock 2, Ark.

TWO \$5.00 U.S. stamps plus 20 different U.S. approvals. Send 10c to Irwin Stamp Co., Box 11P, Brooklyn 30, N. Y.

SAVE Money! Buy stamp packets. World-wide selection. Bargain pricelists free. Webb, 2200 Quintara, San Francisco 16, Calif.

RARE Octagonal stamp, Giant triangle, gorgeous diamond, also mammoth and midget stamps given to foreign approval buyers. Gifts with purchases including Scott's International \$6.00 album, also latest Scott catalogues. Plymouth, Dept. A9, Bell, California.

FIUME 27-32 Mint, 5c. Illustrated price lists. Approvals. Norbert W. Payne, Box 227-P, Orchard Park, New York.

U.S. 150 Different commemoratives, etc. 35c. C. P. Steger, Steger, Ill.

200 DIFFERENT, Including Roosevelt triangle, 10c to approval applicants. M. Avalon Stamp Company, Springfield, Mass.

105 DIFFERENT, Triangles, giant and midget stamps, 15c. Approvals. Bilislands, Box 1101P, Spokane 10, Wash.

RARE U.S. stampless covers over 100 years old, \$1.00 each, 3 for \$2.00. Arkin, 1133 Broadway, New York 10, N. Y.

FREE Sample—Interesting, informative, illustrated! National Stamp News, Anderson, South Carolina.

FREE Scott's International album. Other premiums. Particulars with approvals. Raymax, 35-Z Maiden Lane, New York 38.

100 BRITISH Empire—All different, plus valuable illustrated book "How to Recognize Rare Stamps." Only 10c! Other offers included. Kenmore, Milford 8-XII, N. H.

BETTER Stamps? Try our quality approvals. North Andover Stamp, North Andover, Mass.

111 STAMPS From 111 countries \$1.11. John Bosse, 536 Rush St., Chicago 11, Ill.

GOOD Quality mixture, 30c per 100; 14 pound, \$1.00. Foreign cover included. Thomas Bannigan, Box 211, Rutherford, New Jersey.

FREE 119 Foreign stamps including Africa, Australia, Pakistan, China, India, Russia and Scandinavia. Send 10c for postage and handling. With approvals. Niagara Stamp Co., Niagara-on-the-Lake 81, Canada.

50 DIFFERENT Worldwide 3c! Approvals. Vinny Jo, Box 3082, Seattle 14, Wash.

AMAZING Offer! 200 United States stamps—including commemoratives, airmails, high denominations to \$1.00. Only 10c to approval applicants! Illustrated bargain lists free. Mystic Stamp Co., Dept. 80, Camden, New York.

WONDERFUL Offer—7 complete mint sets only 10c with approvals. Reich (M29), 1633 Lawrence, Chicago 40.

ALBUM! Capacity over 1,000 stamps! Only 10c! Stampmart, Hartford 1, Conn.

CANADA—100 Different, 25c with approvals. Crown Stamps, Box 321, Toronto, Canada.

ZOUNDS! Exciting strange countries packet. Free with approvals! Saxon, Vista, California.

225 STAMPS For only 10c! This mammoth value includes airmails, pictorials; stamps from strange countries cataloguing up to 25c each! Also approvals. Mystic Stamp Company, Camden 80, New York.

50 DIFFERENT Argentine 10c. Approvals. Reuter, 611 W. 40th Pl., Los Angeles 37.

327 DIFFERENT Stamps 25c! Including early Canada, Newfoundland, British Colonies, Vatican, Red Russia, Hitler heads, Indian states, animals, airmails, French Colonies, rarities, unusuals. Every stamp different. Rare bargain with approvals. Money back guarantee. Niagara Stamp Co., Niagara-on-the-Lake 61, Canada.

UNITED States approvals. Select copies. Used, mint. Kingsbury, So. Woodbury 2, Vermont.

100 DIFFERENT Spain 25c. Penny approvals included. Reed, Box 980, Chicago 90, Ill.

FREE! Powerful magnifying glass for 5c post. Bargain lists and approvals. Jamestown Stamp Co., Dept. 207, Jamestown, New York.

WORLD'S Largest stamp (7 1/2 x 14 inches). A real curiosity! Retail for 50c, only 30c to approval applicants. Tatham Stamp Co., Springfield 30, Mass.

OLD Scarce U.S. seconds on approvals. Slight imperfections, lowest prices. Hernefield, Clintonhill Sta., Newark 8, N. J.

UNITED States—40 different 10c; 40 different commemoratives 25c. No approvals. Seidenberg, Appleton 944, Wis.

UNITED States—58 different including 8 airmails, 15 commemoratives, 10c. Approvals. Sunset, Box 47, South Oate, Calif.

TRADE Your extra stamps. Join our stamp club. \$1.00 for two years. Free information. Valley Stamps, Box 87, New Cuyama, Calif.

COLOSSAL Stamp 200 10c. Jungle beasts, wildlife, domestic animals—Fifteen different, including, rhinoceros, elephant, snake, tiger, babu, kangaroo, koalabear, emu, kookabura, bull, horse. Extraordinary accompanying approvals. Niagara Stamp Company, Niagara-on-the-Lake 51, Can.

NEW Zealand triangles. Queen Elizabeth, 10c with approvals. Seminole Stamps, Box 1138-P, Coral Gables 34, Florida.

COINS, TOKENS, CURRENCY

OLD Stamps wanted. I will pay \$100.00 each for 1924 1c green Franklin stamps, rotary perforated eleven (up to \$1,000 each unused). Send 10c for large illustrated folders showing amazing prices paid for old stamps and coins. Vernon Baker, PM-43, Elyria, Ohio.

20 DIFFERENT Coins 50c. Bishoff, Box 2201, Central Station, Kansas City, Mo.

UNITED States rare coin value guide. 48 pages 50c. Fortunes in rare coins. Ideal, 4844-P Geary, San Francisco 18, California.

OLD Money wanted. Will pay \$100.00 for 1894 dime, 8c, mint, \$50.00 for 1913 Liberty head nickel (not buffalo). Big premiums paid for all rare coins. Send 4c for large coin folder. May mean much profit to you. Numismatic Co., Dept. 20, Fort Worth, Texas.

WANTED—Indian cents 1866 thru 1878. Also other U. S. coins. Provenzano, 2419 N. Nerdica, Chicago 35.

LARGE \$1 Bill \$2.50; new \$3.75. Elizabeth Coronation dollar \$2.00; Vatican Holy Year set \$1.25; 256 page guidebook \$1.75; buying handbook \$1.00; giant coin catalogue 25c. Fast service. Bebee's, 4514 North 30th, Omaha 11, Nebraska.

WE Pay \$5.00 to \$500.00 each for hundreds of old or odd United States and foreign coins. Keep all until posted. Send 25 cents for illustrated coin value book with bargain lists. 46 years in business. Coin Exchange, Le Roy 4, New York.

BARGAIN Lists, 10 different Indianhead cents, 50c. Economy Sales, Dean Street, Mansfield, Mass.

THREE Different 2c pieces, \$1. Two different large cents, \$1. Delmaco, Box 1123, Wilmington, Del.

105 DIFFERENT Foreign bills—\$1.00. Free list. Dwight Musser, Dunbar, West Virginia.

FREE! Foreign coin, banknote and coin collectors illustrated catalog to approval service applicants. Send 3c postage. Tatum Coinco, Springfield 30, Mass.

INDIAN Cent with bargain list 10c. Hutchinson, 3463 "T" Street, Philadelphia 14, Penna.

WANTED—1894-S dime pay \$500.00. Certain 1913 nickel \$1,000.00. 1901-S quarter \$20.00 to \$150.00. Hundreds of others. Know their true value. Complete illustrated catalogue 25c. Worthycoin Corporation, D-325, Boston 8, Mass.

GET Profit and pleasure in collecting old coins. Send 10c for 56-page illustrated coin catalog. You'll be delighted with it. Send for it now. B. Max Mehl, 370 Mehl Building, Fort Worth, Texas. Largest rare coin establishment in U. S. Established 54 years.

CONFEDERATE And Southern bank notes, 3 different \$2.00, 50 mixed Indian pennies, \$2.00. Ben's Coin Shop, 31 N. Clark, Chicago 2.

JAPANESE Invasion notes 1c to \$1000.00 set \$1.00, 100pp. illustrated catalogue, 25c. Shultz, Salt Lake City 10, Utah.

WORLD'S Greatest magazine for coin collector's and wooden nickel 10c. Lawrence Brothers, Anamosa, Iowa.

COIN Collector's Magazine. Over 1000 pages per year. Sample copy 30c; \$3.00 per year. Hewitt, 7320-J Milwaukee, Chicago 31.

ANTIQUES, RELICS, INDIAN GOODS, CURIOS

SPRING Relic-Americana catalog 25c. Superior axe-axe, arrowhead and birdpoint \$5.85. Tilton Relics, Topeka 31, Kansas.

WOODEN Indians, size 5 1/2 feet, \$325. Peter Meindl, Raymond, N. H.

6 GEM Points \$2.00, 4 fine arrowheads \$1.00. Good grooved tomahawk \$2.00. List free. Lear's, Glenwood, Arkansas.

QWITTschuerbelleracken: Crowded for space. Selling several hundred historical firearms, 30,000 prehistoric Indian relics, collectors cartridges, coins, confederate money, Revolutionary, Civil, Indian wars flintlocks, muskets, swords, blunderbusses, pepperboxes, snaphaunces, matchlocks, revolvers, frontiers, gun parts. Stagecoach Winchester, Kentucky rifles, powderhorns, bio-horns, steer; deer; buffalo horns. Arrowheads, spearheads, tomahawks. Violin wood, bow-wood, gold dollars, agates, minerals, fossils. Send 35c for profusely illustrated catalog. Helke, (Arrowhead), Wenona, Illinois.

4 PERFECT Arrowheads \$1.00. Flint knife 35c. Perfect pipe \$3.50. Fleisher 35c. Tomahawk \$1.00. Flint fish hook \$1.00. List 10c. H. Daniel, Lamar, Ark.

ANTIQUE Firearms illustrated list 25c. Westbrook, 738 Royal Street, New Orleans, La.

4 SELECTED Arrowheads \$1.00. List 5c. H. Talburt, Calico Rock, Ark.

PRECIOUS STONES, MINERALS

GEMSTONES, Mineral specimens. Every variety. Lowest prices. Free booklet. Plummer's, 4720 Point Loma Ave., San Diego 7, Calif.

ROCKS, Ores, minerals precisely analyzed \$5. Absolute spectrographic detection of 45 elements including uranium. Free information. Keldon Research, Box 1555P, Los Angeles 54, Calif.

RHINESTONES. Jewelry settings, camos, sequins, beads. Send 10c for illustrated catalog. J & M Novelties, Dept. CC-3, Griffith, Ind.

TEN New Mexico minerals \$1.50, six fluorescents \$1.00, fool's gold 25c. Free literature. Minerals, Winston, New Mexico.

GEMCUTTING. Silvercraft authority. Illustrated magazine tells how. Cut rocks, make jewelry. 150 ads illustrating equipment, offering gems for collectors, cutters. Postal brings literature. Lapidary Journal, Drawer B, Palm Desert, Calif.

FUN With rocks! Rockhound's own monthly magazine featuring mapped trips, gem cutting, silverwork, minerals. 9,000 already enjoy it, so will you. Only \$3.00 year. Gems and Minerals, Box 716P, Palm-dale, Calif.

COLLECTORS! \$2.00 Brings twelve beautiful genuine specimens from gem-land Brazil. \$3.00 brings perfectly cut ten carat Braziltopaz. Airmail bills or check. Jean Bach, 413 Praia Icarai, Niteroi, Brazil.

INDUSTRIAL Mineral prospecting pays big when you hit! Free instructions. Stratex Instruments, 1861E Hillhurst, Los Angeles 27.

FIND Tungsten, mercury, uranium with Mineralight. Free brochure. Write Dept. PM8 Ultra-Violet Products, South Pasadena, California.

SAPPHIRE, Topaz, tourmaline, garnet, peridot, 5 uncut gem specimens, \$1.00. O'Brien's, 1116M Wilcox, Hollywood 38, Calif.

HOBBIES AND COLLECTIONS

UNUSED Match books, 200 different \$2.00. Write for price on collectors albums. Ottawa Sales, Iron River, Michigan.

EXCITING Hobby; collect authentic military patches, insignias, campaign ribbons, navy rates, etc. 37 assorted \$1.00. Free gift. Pritt, Dept. M-3, 12 West 27th, New York City.

WANTED Cigarette picture cards. Write Charles Bray, East Bangor, Penna.

HOBBYISTS, Viewcard collectors, world-wide membership lists, one issue 25c, three issues 50c, year \$1.50. Postcard Exchange, Box 4473-A, Dallas, Texas.

UNUSED Matchbook covers, 100 different \$1.00. 36 page catalog 25c. Match-cover album \$3.00. Charles Edelman, 1311C East 84, Cleveland 3, Ohio.

NAZI, Soviet, medals, campaign ribbons. Big packet. Lists, \$1.00. Medcrafts, 1923 34th St. S.W., Calgary 2, Canada.

INVENTING Can be an interesting and profitable hobby. Write for complete particulars. Institute of American Inventors, Dept. 40-E 631-E St. N.W. Washington 4, D. C.

CAMERAS, PHOTO SUPPLIES

NEW Argus C-3 \$51.75. Other terrific savings. Free catalog. Camera Shoppe, Box 601-M3, Mount Vernon, New York.

PHOTOGRAPHERS. Big profits with your camera. Foolproof plan. Customers everywhere. \$1.00. Guaranteed. Lee, 4011-C, Tulsa 9, Oklahoma.

BASS Says: Quality cameras since 1910. When in Chicago visit the camera cross roads of the world, or write us for your favorite equipment, new or used. Satisfaction guaranteed. Bass Camera Co., Dept. AG, 179 W. Madison St., Chicago 2, Ill.

FREE With order—Central's new complete photographic catalog, ready now! Contains complete listings of still and movie cameras and a remarkable selection of photographic accessories, many unduplicated elsewhere. We are known throughout the country as "Photographic Headquarters Since 1899." Send 50c for your copy, you receive full credit on your first order. Central Camera Co., Dept. 9C, 230 S. Wabash Ave., Chicago 4, Ill.

BUY Wholesale nationally advertised cameras, photo supplies, thousands other products at big discount. Free "wholesale plan." American Buyers', 629PP Linden, Buffalo 18, N. Y.

ARGUS C-3, Case, flash, spotless, \$51.90. Argus C-4, case, never used, \$77.00. Free catalogue. 1001 bargains. Dealer's Mart, 54 Beverly Rd., New Rochelle, N. Y.

SUNLITE II Pocket-Pak strobe unit, w/batt., perfect for all shutters, original cartons, \$71.62. Free bargain catalogue. Dealer's Mart, 54 Beverly Rd., New Rochelle, N. Y.

PHOTOGRAPHY For pleasure or profit. Learn at home. Practical basic training. Long established school. Free booklet. American School of Photography, 835 Diversey Parkway, Dept. 3432, Chicago 14, Illinois.

3-D CAMERA, viewer, slidemounts, complete outfit \$20. Keys Stereo, 3823 East 7th, Long Beach 4, Calif.

OIL Coloring photographs—A fascinating hobby or profitable sideline for those with artistic talent. Learn at home. Easy simplified method. Free booklet. National Photo Coloring School, 835 Diversey Parkway, Dept. 3442, Chicago 14.

WHOLESALE Photographic supplies. Cameras, films, projectors, enlargers. Write for free catalog. Capitol Photo Supplies, 2428 Guadalupe, Austin, Texas.

PHOTO FINISHING

35MM Specialists. Fine grain developing. 20 exposures 55c, 36 exposures \$1.40. Free mailers and prices on others. Tops Photo Service, Lyons, New York.

YOUR Photo on stamps. Sheet 100, perforated, gummed \$1.00. Send any photo (returned unharmed!). Miniatures, Williamsbridge, New York City 67.

12 JUMBOS From any size roll developed 25c with this ad only. S. Skrudland, Lake Geneva, Wis.

SPECIAL—3 Jumbos 25c; 12, 45c with this ad. Western, PM-34, Box 298, San Francisco 1, Calif.

GUARANTEED Quality. Fast service. Eight jumbos in beautiful super pak plastic ring binder albums only 35c. Send for free mailers and particulars of our complete photo finishing service. Grand Fotos, G.P.O. Box 1410, New York 1, N. Y.

YOUR Photo on stamps, real photographs in stamp form. Reproduced from any size photo, snapshot or negative. Free samples. American Novelty Creations Co., Dept. 1-M, P.O. Box 4624, San Francisco 3, Calif.

TWO Prints each good negative, 8 exposures, 35c; 12 exposures, 50c; reprints, 4c. Mayfair Photo Service, Box 617-K, Toledo 1, Ohio.

TOP Quality. Fast service. 8 jumbos 35c in beautiful super pak album. 16 contacts 40c. Reprints—Jumbos 4c; contacts 3c. Satisfaction guaranteed. Write for free mailers and circulars. Fast-X-Photo, Box A, Jersey City, N. J.

TWO Beautiful prints from each picture on 8 exposure roll 35c. Many years of satisfied customers. Quick service. Lens Photos, Dept. J-4, Janesville, Wis.

WILD Animal and bird films in beautiful color or b. and w. 2" x 2" slides and 8mm or 16mm movies. Write for free literature. Wild Life Films, 5151 AB Strohm Ave., North Hollywood, Calif.

CUSTOM Jumbo album prints! 8 exposure 35c; 12, 50c. Special! 35mm 36 exp. \$1.00. Free mailer. Flash Foto, Box 36M, Brooklyn 4, N. Y.

6 OR 8 Picture roll 35c. 12 or 16 picture roll 55c. Each roll developed and printed in handy album pack. Send coin with roll. No c.o.d.'s. Mailing containers sent free. Deluxe Film Service, Box 1268-A, Shreveport, Louisiana.

ENLARGEMENTS, 8x10 Oil colored \$2.00. Miniatures. Free price lists. George Brewer, 5864-D Hollywood Blvd., Hollywood 28, California.

ENLARGEMENTS! Eight 5 x 7's or five 8 x 10's, \$1.00. Wliart Enlargers, Box 997, Little Rock, Ark.

BEAUTIFUL Enlargement in album from each good picture on roll. 8 exposure, 40c; 12 exposure, 50c; 16 exposure, 65c. Cut Rate Photos, Dept. B-4, Janesville, Wis.

MOTION PICTURES AND SOUND EQUIPMENT

8MM., 16MM. National parks in Kodachrome. Send dime. Ideal, 4644 Geary, San Francisco 18, California.

SOUND Films, war, aircraft, Pacific, medical, refrigeration, etc. \$3.00 up. Lists. Abbe Films, 503 5th Ave., New York 17.

8MM., 16MM. Projectors, accessories, film. Ideal Service, 4644-PM Geary, San Francisco 18, California.

CLEARANCE Sale of 16mm. sound films. Want a real buy in 16mm. sound films? Take advantage of the I.C.S. 1954 clearance sale of 16mm. sound features, comedies, cartoons, educational films, religious subjects—new, used. Send for our giant list "A" today stating machine you own (make and model). Institutional Cinema Service, Inc., 1560-PM Broadway, New York 19, N. Y.

WOW! We've got everything: collector's items; new releases. Free catalog: Sample slide 25c. Vanity Productions, Dept. 10, 95 Seneca Street, Seattle 1, Washington.

8MM. Movie subjects. New 150' films, \$2.98. Dime brings 32-page, 1954 catalog. 50' 8mm. Prevue film and catalog, 59c. Blackhawk Films, 1236 Eastin Bldg., Davenport, Iowa.

PERSONALIZED Titles improve your movies. Free brochure. Sierra Western, 2748-B2 East Broadway, Long Beach 3, Calif.

16MM. Movie subjects. New 300' 16mm. sound releases, \$11.95. Bargain prices on hundreds used 16mm. sound, silent prints. Dime brings 32-page, 1954 catalog. Blackhawk Films, 1237 Eastin Bldg., Davenport, Iowa.

"ENTIRE Life Story of Christ." 8mm., 16mm., sound and silent, purchase or rent, state projector. Hemenway Film, 319 Church St., Boston 16, Mass.

8 & 16MM. Professional national parks movies in Kodachrome, list 10c. Ideal, 4644 W. Geary, San Francisco 18, California.

16MM. Sound projectors—Excellent used units, all makes, \$119.95 up; some \$99.95. Dime brings 32-page catalog equipment, films. Blackhawk Films, 1236 Eastin Bldg., Davenport, Iowa.

3,000 8-16MM. Silent-sound films. International, 2120 Strauss, Brooklyn 12.

EARN Up to \$15.00 daily with your movie projector! Details free! Metcalf, 10806 Glenroy, Chicago 43.

8-16MM. Silent-sound films. Complete rental library. All latest subjects. Free catalogue, sample film 10c. Garden Film, 317 West 50th, New York 19.

MOVIE Camera film: 8mm. roll \$1.50, 16mm. 100' \$3.00. Free processing. Better Films, 742 New Lots, Brooklyn, N. Y.

TAPE Recorders, tapes, accessories. Unusual values. Dressner, 624-M East 20th Street, New York City 9.

GUARANTEED Fresh 8mm. roll, magazine; 16mm. roll, magazine movie films. Color, b&w. Free catalog. ESO-R, 47th Holly, Kansas City 2, Missouri.

MUSIC AND MUSICAL INSTRUMENTS

HARMONICA, Swing band, only \$1.00. Prince, 29 South Cicero, Chicago 44.

CONCERTINAS: New, used, all sizes. Wenzel Fischer, New Ulm, Minn.

OUTSTANDING Proposition for poem writers. Wescourt, 216 West Jackson, Chicago.

SWISS Music movements assorted tunes \$1.70. Helax, 218 West 72nd Street, New York City.

ACCORDIONS, Wholesale to every one. Save 30% or more. All national known makes. Free catalogue. Del Principe, 29 South Cicero, Chicago 44.

NEW Songwriters can now sell their songs! My new, easy method reveals professional secrets of profitable songwriting. Free details. Meadowlark Music School, 274 Sumner Road, Colorado Springs, Colo.

YOU Can play the piano by ear—in one week. By the quickest easiest short cut system in the world. Gives all tricks and pointers for playing correct bass with left hand, the main secret in playing by ear. Write R. S. Appleton, Box 135, Leominster, Mass.

VEST-Pocket chord chart, 180 notated chords, symbols, \$1.00. Ted Smith, 14 Salvadore Circle, Danvers, Mass.

STUDENTS Of violin or viola. Quickly improve your tone quality. Your further study will be pleasant, your interest keener. Bowing exercise \$1.00. Thirty day refund period. M. L. Stayner, 1172 First Avenue, Salt Lake City 3, Utah.

MUSIC Arranged. Songs printed. Frank Wildt, Music Publisher, Lancaster, Penna.

SONGPOEMS Wanted. Mail to: Tin Pan Alley, Inc., 1650 Broadway, New York 19, N. Y.

SONGWRITERS—Join Amateur Songwriters Club of America. Free details. Asca, Box 433-C, Hamilton, Texas.

POEMS Wanted for musical setting. Send poems. Free examination. Crown Music Company, 1476 Broadway, New York City 36.

POEMS Wanted for musical setting. Send poems. Free examination. Five Star Music Masters, 630 Beacon Bldg., Boston, Massachusetts.

FREE Record of your song. Your words, my melody. Free information. Johnny Mack's Melody Mart, 1094 West 29th Street, Dept. A, Los Angeles 37.

ACCORDIONS And other musical instruments wholesale. Music Center, Plymouth, Ind.

SONGWRITERS! Let me help you. Stamp for booklet. Mark Rubens, 146-D West 79 St., New York 24, N. Y.

SONGWRITERS! Protect your ideas! Hold all songs, poems! Write for safe correct procedure first! Song Service, Dept. P, 333 W. 56th St., New York 19, N. Y.

POPULAR Songs. How to write and sell them. Write for free booklet Successful Songwriting. Gateway Songs, Box 2470, Hollywood 28, Calif.

SONGWRITERS! Send poems, songs. Music Service, 243 West 72nd St., PM, New York 23.

POEMS Wanted to be set to music. Free examination. Send poems. McNeil, Master of Music, 510-PM S. Alexandria, Los Angeles, California.

WRITE Songs. Big money and reputation. Write for information. J. Gordon Pub. Co., 4700 South California Avenue, Chicago.

POEMS Wanted for musical setting. Send poem for immediate consideration and free rhyming dictionary. Richard Brothers, 24 Woods Building, Chicago 1.

RADIO AND TELEVISION

FREE 268 Page 1954 television-radio-electronics catalog! World's largest stocks, lowest prices. Complete supplies for builders, experimenters, amateurs, servicemen. Latest TV, Hi-Fi, radios, phonos, recorders, P.A. equipment. Thousands of parts, tubes, test instruments, books, diagrams. Top quality money-saving values. Get your copy now! Allied Radio Corp., 100 N. Western Ave., Dept. 34-C-4, Chicago 80, Ill.

GUARANTEED Television, radio tubes. Lowest prices. 6AU6, 6CB6, 50c; 12AU7, 6AG5, 6BC5, 6SN7GT, 68c; 6AQ5, 6AL5, 6BA6 48c. Free price list. Contains bonus offer. Crown Television, Box 194, Hicksville, N. Y.

BUILD Crystal radios. Sensational Melomite crystal and detector with instructions and plans, 50c postpaid. Satisfaction guaranteed. Allen, 427-PM5, Clinton, Missouri.

STOP Radio television noise. Patented filter eliminates interferences household appliances, motors. \$1.00 postpaid. Lang, 8709 114th, Richmond Hill, N. Y.

SAVE 80% Television repair costs. Simple as changing light bulbs. Send television make and model with \$1.00. Box 1295, Greenville, S. C.

NEW 3200 Volt power transformers. Government cost \$40, our price \$12 f.o.b. Shipping weight 55 pounds. Modern Enterprises, Cynthia, Kentucky.

CLEARCO Crystal radio kit \$1.50; preassembled \$1.75. Free catalogue. Clearco Crystal Co., Box 1857, Milwaukee, Wis.

MAKE Your own crystal radio from odds and ends around the house. Only 25c for plans with sensitive galena crystal. Lee, Box 6908, Kansas City, Mo.

AUDIOPHILE Bulletin, monthly confidential hi-fi equipment reports. \$2.00 year. Department G, 1379 East 15th, Brooklyn 30, N. Y.

DIAGRAMS For repairing your radio \$1.00, television \$2.00. Give make and model. Diagram Service, 673-PM, Hartford, Conn.

TV Home repair book saves you money. \$1.00 postpaid. Benty, 1834 Belmont Ave., Chicago, Ill.

BUILD 15 Radios—Only \$19.95 complete. Free radio tester, tools, soldering iron. No experience required. Money-back guarantee. Order direct or send for descriptive literature. Free valuable radio and TV repair guide on request. Progressive Edu-Kits Inc., 497 Union Ave., Dept. PM15, Brooklyn 11, N. Y.

SIMPLIFIED Radio repairing instructions, \$1.00. Slate's Radio Service, Corsicana, Texas.

P.C.C. Commercial operator license quickly. Grantham, 6064 Hollywood Blvd., Hollywood 28, California.

BUILDER'S Pictorial construction handbook, 25c. Alena, Box 24, Astoria 6, N. Y.

CUT-O-Sound silences irritating commercials from your viewing chair. Simply attached, only \$2.45. Easy to assemble kit, with directions \$1.50; guaranteed. Brandon Associates, Drawer 1191, Altoona, Penna.

TELEVISION Instructions \$2.00 set. Electronic Communications, Box 567, Springfield, Missouri.

CRYSTAL Radio needs no antenna, ground. Receives while carrying. Ideal on bicycles. Plans 50c. David, Box 6008, Kansas City, Mo.

AMAZING, Everything in one. Troubleshoots every television and radio. Write for free information. Tele Diagnosis, 155 W. 72, New York.

BUILD Your own top quality TV set. We supply complete equipment, tools, instructions as part of America's finest home-study TV course. Be a high-paid TV technician. Install, repair, service all makes of sets. Many excellent jobs now open. Or start your own business. Get full facts free. Write: Commercial Trades Institute, Dept. CT2-3, 1400 Greenleaf Ave., Chicago 26, Ill.

BUILD Your own electronic organ, or miniature electronic brain. Free details. Jim Kirk, 1552 Church Street, San Francisco 14, Calif.

FREE. Get on our radio and electronics mailing list. A.R.I., Box 1438, Denver, Colorado.

CRYSTAL Radio experimenters. Write Leslie Hulet, R4, Lakewood, New Jersey.

LIMITED Quantity surplus double headphones. High quality, slightly used. \$7.95 value. Special now \$2.95 postpaid. Guaranteed. Allen, Dept. PMH, Clinton, Mo.

COLOR Television! Enjoy multi-color filter screen now. Easily attached. Send \$2 for your screen size. Satisfaction guaranteed. Dealers opportunity. Zingo Products, Johnstown 7, New York.

BUSINESS OPPORTUNITIES

EARN Money typing, sewing! Details free. Edwards, 3915-PM, 12th, Des Moines 13, Iowa.

START Home mailorder business. Details. Gimbirt, 1454 West Washington, Petersburg, Virginia.

\$200 WEEKLY Reported! No selling. Free booklet. T. J. Surface, Roanoke 4, Virginia.

STRIKE It rich in your own business, full, spare time! Authentic new guide, gives concrete instructions; explains "Ways to Make Money, have Happiness, Success!" Start with little, snowball to plenty, independence! This thrilling guide helps find your lifetime opportunity! Further details free! Wonderful Products, Box 2113-H, Santa Fe, N. M.

FOR The best mailorder deal in America, write Modern Enterprises, Cynthia 1, Kentucky.

BUY At discount—Appliances, watches, silver, gifts. Catalog 50c (refundable). Hannibal Buying Service, Madisonville, Tenn.

INEXPERIENCED Make money! First day! Repairing sewing machines. Nothing like it! Costs \$5.00, makes \$500.00. Write, Purdy's Guaranteed Instructions, 1416 1/2 North Rusk, Weatherford, Texas.

LIST Your name in "big mails." Get opportunities, catalogs, samples. One issue 10c, three issues 25c. Walter Rix, P.O. Box 6521, Cleveland 1, Ohio.

SELL Popular Mechanics and all other magazine subscriptions. Free catalog, supplies. Subscription Service Company, Dept. A, P.O. Box 2070, Birmingham, Ala.

EARN \$2.00 Hour! I do, making sandals. Young's, 1308-PM, South First, Arcadia, California.

MAKE Flexible molds. Cast figurines, plaques. Free sample. Tooker, 630-R Chestnut, Hamilton, Ohio.

TIN-Cans. Turn it into cash. Nine methods. Instructions 50c. Charles Company, 12-DBR, Norwood, Ohio.

SAWDUST. Turn it into cash. Twenty methods. Instructions 50c. Charles Company, 12-DBP, Norwood, Ohio.

MAKE Tough, durable plastic of waste—Easily. Makes attractive, resilient floors, walls, built-ins etc. Build good home for half. Bays Laboratory, Oklahoma City 9.

BUILD Medium 3 bedroom home—\$590. Itemized details free. Buildit, Box 322, Arkansas City, Kas.

NEED Capital? Free details. How and where you can get any amount. Colburn, 429-P South Wetherly, Beverly Hills, Calif.

\$900 A Year sparetime sharpening saws at home. No selling. Hardware stores get saws on commission basis. Free booklet tells how. Frank Foley Company, Columbia Heights, Minnesota.

MILLION Articles wholesale. Supply source directory 25c. Idealer, Park Ridge, Illinois.

PACKAGED Food mailorder business. Home operated. Everything supplied. Successful proven plan. Free details. Frazar Foods, Desert Springs 13, California.

HOW And where to obtain capital. Particulars free. Star Service, Wapakoneta, Ohio.

MAIL Order beginners. Start operating immediately. Real merchandise. Everything furnished. Get \$10.00 orders. 100% profit. Don't wait. Get started. Information free. Dumont, Room 612, 216 West Jackson, Chicago 6.

EXPORT Business easy made! Substantial income from home. No merchandise buying. Full setup service, includes everything. Hermes Exports, 152 West 42, New York 18.

EARN \$5 Hourly contracting floor sanding; evenings—Weekends or full time. Machinery sold, nothing down, balance monthly payments. Rader, Box 2456, Kansas City 14, Missouri.

MAKE Perfumes, other products at home. Write Carey, 1914-PM3 Chouteau, St. Louis 3, Missouri.

LEARN Exterminating. Formulas, secrets, what to charge. Big profits, free details. Knox, 1208 Walnut, Philadelphia 7, Penna.

HAVE Home business mailing literature. Easy, pleasant, profitable. Everything furnished. Write: Sherron, Box 343P, Bloomfield, New Jersey.

NEED Money? Want independence? Your own boss. Start home mail order business on shoestring. Write: Cox, Saugus 10, Mass.

YEAR Round air conditioning taught. Install, service units, save hundreds on own home. Don Gardner, Box 4287, Philadelphia 44, Penna.

BUILD Luggage and cases at home. We sell your products. No special equipment needed. Free details. Cascraft, 803-P4 Sunset Blvd., Los Angeles.

MAKE Perfumes, other products, home. Sell mailorder. Catalogue free. International, 6347 Parnell-PM-3, Chicago 21, Ill.

NEWEST Spare, full-time home business, \$5 to \$10 hour possible. Paint with suede—The finish with touch and eye appeal. Beautiful auto dashboards, signs, radios, toys, figurines, lamps—1001 others. Complete, step-by-step instructions sent for no-risk examination. Free details. Coast, 1004-JB So. Los Angeles St., Los Angeles 15.

PAINT—Sell figurines, plaques. Free folder. Plasterines, 105P Parkway, Tiffin, Ohio.

ADVERTISING Book matches—Cash in on big demand; sell union label matches. Cuts for all businesses and political parties. Free powerhouse selling kit, low prices, protection guaranteed on repeat orders. Cash commissions. Superior Match Co., Dept. MX-354, 7530 Greenwood, Chicago.

\$26,500 SALES in two weeks! Amazing radio-mail order method. Free details. Broadcast Service, 1412-K Great Northern Building, Chicago 4, Illinois.

MAKE Money at home. Write, Falcon House, Winnebago 2, Ill.

IMPORT-Export; Opportunity, profitable, world-wide, mail-order business from home, without capital; or travel abroad. Established world trader ships instructions for no-risk examination. Experience unnecessary. Free details. Mellinger 703, Los Angeles 24.

START Home mailorder business. Details. Gedgard, Box 738-M, New York 1, N. Y.

HOME Business sharpening lawnmowers sparetime brings \$100.00 monthly. Get business through hardware. No experience necessary. Send for free instruction book and business plan. Vernon M. Foley Company, Columbia Heights, Minnesota.

LIQUID Rubber, make flexible molds. Free sample. Chaney, 1130 E. 16th St., Jacksonville 6, Fla.

RAISE Orchids—At home. Big profits. Fascinating. Year 'round any climate. No greenhouse. Instructions, including blooming-size orchid plant, sent for no-risk examination. Free details. Flowerland, 4822-DW, Wilshire, Los Angeles 5.

START in mailorder without capital for merchandise and advertising. Information free. Morris Colson, Park Hotel, Quincy, Illinois.

GET Details on profitable mail order business. Write J. Machlica, P.O. Box 7, New York 57, N. Y.

START Your own business on credit. Your own boss. 1638 of our dealers sold \$5,000 to \$27,500 in 1953. We supply stocks, equipment on credit. 200 home necessities. Sales experience unnecessary. Pleasant profitable business backed by world-wide industry. Write Rawleigh's, Dept. C-U-PPM, Freeport, Ill.

WHAT'S Your field of interest? Whatever it is, specialized magazines will help you get ahead. Examine current copies of those covering your field through our easy-to-get-acquainted service. Choose from 4,387 covering all fields—Business, trades, agricultural, professions, insurance, real estate, music, educational, hobbies, sports, etc. Current list free. Commercial Engraving Publishing Company, 340 North Ritter, Indianapolis 19, Indiana.

SEWING Machine—Repair, sales, servicemen needed. Previous experience unnecessary. Operate home setup. Spare, full time. New zigzag machines, motors, parts, etc., supplied. Write today. Taylor Service Co., Hamilton PM-3, Ohio.

LIVE in fabulous Florida, the land of eternal sunshine! Hunt, swim, boat, fish, golf twelve months out of every year. Florida is growing so fast it offers some of the best opportunities to go into business available anywhere in the U. S. Be your own boss, opportunity is knocking. Many small businesses available, sundry stores, taverns, luncheonettes, auto repair shops, radio and T.V. stores and shops, etc. Many earning \$100-\$150 week can be handled with only \$1,000-\$1,500 cash. Don't wait, investigate now. Send \$1.00 to cover handling and postage, for our latest catalog of over 100 selected business opportunities, recommended by Florida's most active business brokerage organization. Hundreds of satisfied clients. Florida Business Brokers, 235 W. Plagler St., Miami 36, Fla. Member Chamber of Commerce.

OWN Your mail-order paper products business. Envelopes, tags, bags, boxes, wholesale. No investment. Omaha Envelope Service, Dept. 14, 4721 California, Omaha 3, Nebraska.

PROFITABLE And fascinating hobby. Grow miniature trees. Send only \$2.00 for 100 rare seeds, (7 varieties) and complete instructions. Bonsai Gardens, Box 7659, Paynesville, Minnesota.

PROVEN Best stucco and masonry paint, joints, cracks, spackling, for formulas and full information write, A. E. Larson, 3419 So. 9th East, Salt Lake City 6, Utah.

MAIL Letters featuring real merchandise. Get \$10 orders in every mail. 100% profit. Everything furnished. Write, Dwight C. Buxick, Boulder Creek, Calif.

RAISE Canaries, huge profits. We instruct. Doc Larkin, Broughton at Jefferson, Savannah 4, Ga.

BIG Profits weaving rugs. Send 10c for our catalog, sample card, and low prices on carpet warps, rug fillers, looms, parts, inexpensive beam counter. If you have a loom, give make and width please. Or. Rug Company, Dept. 3477, Lima, Ohio.

MAKE Big money at home! Invisible re-weaving pays \$10 profit an hour spare time. Make tears, cuts, holes disappear from fabrics. Constant demand from laundries, cleaners, homes assures steady earnings. Details free. Fabricon, Dept. AE, 8342 S. Prairie, Chicago 19, Ill.

PERFUMERS; Cut costs, 500 fragrances, supplies. Box 3267, San Diego 3, Calif.

NEW Ideas! Foreign magazines in English. Export-import, handicrafts, hobbies, and others. Copies available. Free list. Caron, 45 Fairview, North Plainfield, N. J.

WHY Job worry? Start electroplating, metal finishing business. Free information, trade secrets. Plater F. Hyde, 377 West 120th Street, Los Angeles 51, California.

BUY Wholesale. 20-50% off. Siegel, Box 181PM, New York 2.

HOW To set up and run a mirror shop! Resilvering mirrors. Making chipped glass nameplates. Electroplating salts and rectifiers. John Sprinkle V60, Marion, Ind.

WANTED! Home producers, by manufacturers in our clearing house service. Become a subcontractor, casting plastic products for these companies. Thousands of easy-to-make items required for consumer and industrial use. Cash in at home, without previous experience. Plastic Service Associates, Dept. 3-PM, East Boston 28, Mass.

DO-It-Yourself — Dealer distributors wanted. Manufacturer of all-aluminum combination screens, storm windows, doors, shower doors, etc., wants to establish franchised exclusive retail-wholesale outlets. All materials and products of proven highest quality, priced below competition. Distributors can offer new fields of appeal to the home craftsman. Mouldings, bars, strips, channels, and special designed forms available to fabricate, make and repair 1001 items at a fraction of normal reproduction costs. Nominal investment will set you up in business to make tremendous profits. Modern Rolling Corp., 541 West Lake St., Chicago.

ENGRAVE Plastic titleplates, make profits to \$5 hour! Sensational new engraving machine "DupliScaler." Details, sample 25c. Desco Distrib., 6334-B Sepulveda, Van Nuys, Calif.

OWN, Operate, route—"Wishing wells." Place these new \$8.50 skill games on counters in cafes, luncheonettes, clubs, etc., collect coins weekly. Write, Legalsharo, Box 929, Long Beach 1, California.

FREE! "301 Profitable Small Businesses!" Amazing shoestring plans! Work home! Start sparetime! Deumant Surveys, Kenmore 23-PM, N. Y.

BUY Wholesale. Hundreds nationally advertised products. Watches, housewares, jewelry, appliances, etc. Save. Make money. Free details. National Buying Service, Radio City Station, Dept. M, Box 324, New York City 19, N. Y.

LOOK Over this method in mailorder. Income steady. Literature free. Shore Enterprises, Box 213-C, Neptune, N. J.

MAIL Letters from your home—Get \$5-\$10 orders in every mail. Keep half. A. Dadson, 4815 Bellinole, Houston, Texas.

LEARN About Florida's opportunities for you. Businessmen—Industrialists: Florida abounds with opportunities of many kinds for large and small businesses and industries. Highly favorable tax climate. Free, complete information available. Write, stating specific requirements, and you'll be put in touch with communities offering what you need. Write today as the first step toward locating in wonderful Florida. Address: State of Florida, 4314E Caldwell Building, Tallahassee, Florida.

ESTABLISH Profitable automatic shoe shine route. Proven. Write Jiffy Shine, 1630 S. 2nd St., Philadelphia, Penna.

MAKING Money is not difficult. We have solved problems for the big fellows for years, now we hope to give the "little guy" a break. Drop a card to Crusading Merchandisers, 7832 Lockwood Street, Oakland 21, California.

A Big-paying business for a man in his 50's. One of our men makes \$11,000 in a year, other top men in their 50's earn up to \$5,000 to \$8,000 right from the start. We pay earnings in advance. Require no investment. Write confidential letter to Vice President, Dept. PM, Box 676, Dayton 1, Ohio.

BE Your own boss. Experience unnecessary. Get the book "169 Ways to Earn Extra Money." Send \$2 to Field, Dept. PM-5, Col. Cir., New York 19, N. Y.

WHY Be broke? Sell by mail to new mothers. Big profits. Everything furnished. Write, Allen, Box 4-A, Houma, Louisiana.

HAVE Home mail business—No outside work. New course tells how. Descriptive folder free. Pullmer, 92-M, Greenwood, Pocatello, Idaho.

MAKE—Sell finest perfumes—Terrific profits. Everything furnished. Cash in on \$100,000.000 business. Driver, 337 So. Beverweck, Parsippany, N. J.

NEW Kind mail order—Start on shoestring. No investment for advertising-merchandise. Eastern, Box 142-N, Boston 24, Mass.

START A buying service, buy wholesale thousands nationally advertised products. Make big profits selling at sizable discounts. Postcard brings details. American Buyers, 627-P Linden, Buffalo, N. Y.

EASTER Lycopodium reflective styrofoam crosses. Fascinating bouquet and wreath course. Enclose 25c for course. Lycopodium Foundation, St. Paul 13, Minn.

\$1 ESTABLISHES Your mail order or retail business. Ide, 23 Robbin Hill, Scarsdale, N. Y.

YOUR Own business. Start now. Established sources, channels, contacts. Details. Woodward, 697A, Cambridge, New York.

BOOKKEEPERS—Earn up to \$520 month serving small firms part or full time. Proved plan; simplified system. Particulars free. Tax Saver System, Dept. B, Fort Worth 2, Texas.

PROFITABLE Enterprise. Work home. Free literature. Thomas Walker, 3042 Madeline Street, Oakland 2, California.

OPERATE Profitable mailorder letter shop. Write, Continental Publishers, 1332 So. 61st, Milwaukee 14, Wisconsin.

MEXICO! Curious wholesale! Excellent gift shop items! Illustrated pricelist 3c stamp. Filmer, 910 Marion, Pharr 10, Texas.

TO \$40.00 Weekly. Sparetime, home operated mailorder business. Successful beginner's plan. Everything supplied. Lynn, 10420-M National, Los Angeles 34, Calif.

SPARE Time business. No investment. Details free. Howell, 1320 St. Andrew, New Orleans 13, La.

OWN A garden golf business. Experience unnecessary. Brockway, Seaside, Oregon.

COPUBLISH Mail Sale Advertiser, leading mail order paper. Details, latest copy, dime. Vanroy Shirk, Lebanon, Penna.

EARN Money at home! Homemaker Magazine tells how. Sample, 25c. Sizemore, Box 7, 4917 Kostner, Chicago 30.

EARN Big money by mail. Depression-proof income. Circular 15 cents. Complete starting deal \$3.00 postpaid. Reho, Box 21A, Whitsett, Penna.

IMPORT! Export! Profitable details free. Warner's, Box 6, Ft. Scott, Kansas.

UNCLE Sam tells how to finance your business. 15c. A-B Enterprises, Dept. P2, 9814 McMillan Ave., Silver Spring, Maryland.

DOLLARS in personalized baby record books. Sell by mail. Eleven thousand new prospects daily. Use same literature we do. No-Co-Ro, Oakland 8, California.

MAKE Rubber stamps, repair dolls; learn silk screen printing; invisible reweaving. Catalogue (60 ideas) free. Universal, Box 1076-A, Peoria, Ill.

SCHEMER Magazine, Canfield 1, Ohio, monthly mailorder ideas, plans. Year \$1.00. Sample 20c.

EARTHWORM Breeding! Bait! Soil! Easy! Profitable! Get unusual story. "An Earthworm Turned His Life." Send dime. Earthmaster System, Dept. 14B, El Monte, Calif.

ELECTROPLATE Auto parts, novelties, mirrors, baby shoes, etc. Easy, inexpensive home processes. Free booklet. Tyco Metals, Box 13231-MM, Houston 19, Texas.

SENSATIONAL Money making opportunity. Biggest amazing you've ever seen. Agency, West Liberty, Iowa.

\$45 PROFIT From one bag of cement. McComb & Son, Hometown 1, Indiana.

TREMENDOUS Profit—Ornaments for dresses, coats, hats, easily made. Sell thousands for Easter. Start now! Sample kit 25c. Miles Crafts, 3220P Fish Avenue, New York 69, New York.

NATURAL Molding rubber, extra thick. Free sample. Flock, tinsel, candle wax. W. Wooley, 115-A Donald, Peoria, Ill.

FIBERGLAS—Wonder material for boats, auto bodies, etc. New field opening. Earn while you learn. General practice kit and instruction manual \$5.00. United States Fiberglass-Resin Company, 723 East Washington, Los Angeles 21, Calif.

MAKE Money by mail order. Free catalogue shows how. Details free. Opportunities Unlimited, Dept. 6, Box 1576, Boston, Mass.

EXCLUSIVE Chemist-developed formulas for modern manufacturing success. Literature free. Millar, Chemist, Tampa, Florida.

PLASTERCRAFT Molds, liquid rubber, plasters, flocks, candle supplies. Catalog and manual free. Blue Rapids Supply, Blue Rapids, Kansas.

PLUNGING into small business? We did! Free outline pitfalls to watch. Taylors, Box 206-M, Three Lakes, Wisconsin.

EARN Money! Amazing plans! Easily mastered. Details. Bruns, 216-B West Jackson, Chicago 6, Illinois.

NEED Capital? I'll tell you how and where to get it. Write, Dougherty, Box 83-J, Van Nuys, Calif.

LATEX For molds. Free instructions casting statuary, novelties. Major Chemical, 23 Allerton St., Boston 19, Mass.

A Business of your own financed entirely by mail. Can be started during spare time. McCann, 1612 Johnson, Amarillo, Texas.

MOLD Making liquid rubber; quarter pint sample with instructions, \$1.00 postpaid. Plastercraft Supply Company, 3051 St. Clair Ave., Cleveland 14, Ohio.

FREE Vending machines; if used to sell our profitable nuts. Continental, Box 1361-A, Milwaukee 1, Wisconsin.

BIG Money. Amazing new home business. Pearl finish baby shoes. Free plan. Pearl Art, 7216 Bear, Bell 1, Calif.

GROW Mushrooms. Cellar, shed, and outdoors. Spare, full time, year round. We pay \$3.50 lb. We paid Babbitt \$4,165.00 in few weeks. Free book. Washington Mushroom Ind., Dept. 172, 2954 Admiral Way, Seattle, Washington.

COLOR Concrete with chemicals. Marble-glaze cement benches, pottery, garden ornaments. Home—shop. 10c brings sample, pictures. Hollywood Cementcraft, 8527-R Wonderland, Hollywood 46, Calif.

HOMEWORKERS Wanted: Mailing publications. Sample, details and big instructive manual only 25c. Dispenza, 2020 Harbor Ave., Ashtabula, Ohio.

MAKE Money at home as renewal headquarters for all magazines. Liberal commissions. No experience—No capital needed. Supplies furnished. Write for free catalog. McGregor Magazine Agency, Dept. 500 B, Mount Morris, Ill.

POPCORN And potato chip equipment. Leco, Box 933-A, Springfield, Ohio.

START Sparetime home mailorder business. Pays big profits. Amazing instructive book. 25c. Moneyback guarantee. Tomlin Service, 850 Ocean, Portland 5, Maine.

BUY It wholesale! Manufacturers, distributors offer 850,000 items. Literature free. Olsen, 1231-A East Third St., Duluth 5, Minn.

BOOKKEEPERS. Increase earnings operating sensational bookkeeping service. Kern, 4942 Vineland, North Hollywood, Calif.

\$46 FROM Square foot plywood; Sigsaw necessary. Write: Woodarts, Bridgewater, Mass.

MAILORDER—Operate profitable home business using free advertising method reaching millions. Revealing information free. H. F. Seidel, 7070 Hollywood Blvd., Hollywood 28, California.

MEN, Women! Make money at home or build your own mailorder business spare time. Free booklet reveals secrets. Write: Spadco Surveys, 413 Portland, Rochester 5, New York.

BUY Wholesale thousands items. Lists free. Cottage Industries, Omaha 12, Nebr.

MAKE Money selling by mail; instructive booklet 25c. Manhattan House, P.O. Box 51-M, Saint Albans 12, N. Y.

\$25 WEEKLY Working two hours daily at home. Lycke, Box 2471-A, Cleveland 12, Ohio.

START Your own profitable home mail-order business! We supply everything! Write today! Studio Products, Box 564-A, Glendale 5, Calif.

BREED Rare tropical fish at home. Earn big money! Learn secrets! Help fill huge demand. Amazing opportunity! Free plan. Tropicals, 1008-F Los Angeles St., Los Angeles 15.

INCOME From local information. No selling. Write Neherco, La Verne, Calif.

RESILVERING Mirrors, formula 50c; two-way lookout mirrors. (No one sees you), 50c; coppered mirrors, 50c. All \$1.00. Nelko-Mir, Box 3462-J, Chicago 54.

START Home manufacturing business. Make cleaners, soaps, polishes, cosmetics. Free literature. Kemix, Park Ridge, Ill.

MAKE Money spare or full time, casting metal toys and novelties. Big wholesale and chain store demand for autos, soldiers, ashtrays, banks, etc., keeps manufacturers busy. Production moulds furnished for up to 100 and more castings per hour. No experience or special place necessary. Write for information and illustrations of patterns needed. Metal Cast Products Co., Dept. A, 1694 Boston Road, New York 60, N. Y.

LIVING Miniature ("Ming") trees only 10 to 20 inches tall. Grow at home. Big profits! Spare time opportunity. Fascinating! Amazing! Write for free seed and plan. National Nursery, Dept. FC, Inglewood 4, California.

NEW Exceptionally profitable plans, ideas for home operated mail business. Rush name. Miller, 1772-P Carlyen Road, East Cleveland 12, Ohio.

RECAST Old batteries into new. Latest achievements. Battery Laboratories, Minneapolis.

GOOD Paying business silvering mirrors, plating autoparts, reflectors, bicycles, bathroom fixtures, etc., by safe method. No tanks or shop required. Outfit furnished. Free booklet. Gunmetal Co., Ave. H, Decatur, Illinois.

OPERATE Profitable mail order business. Write Walter Service, 4159-A East 112th, Cleveland 5, Ohio.

MINK Raising information free. Complete. Lake Superior Mink Farm, Superior, EE1, Wisconsin.

COLORGLAZED Concrete pottery made without molds. Patented method. Cemetery products, novelties, tiles. Basement leak-sealing. Money-making projects. Booklet, details free. Men only. National Potteries Company, Grand Rapids, Minnesota.

FREE Book "505 Odd, Successful Businesses." Work home. Expect something odd! Pacific, Oceanide, Calif.

137 PLANS For starting home business. Details: Elite Co., 220 Grand St., New York 12.

FIX Typewriters. Free booklet describes our modern, inexpensive home-study course. Factory methods taught. Write Typewriter, Building 1, Tarentum, Penna.

MONEY In new greaseless doughnuts. Start in kitchen. No smoke. Sell stores. Free recipes. M. Ray Company, 3605 South 15th Ave., Minneapolis 7, Minn.

VENDING Machines—No selling. Operate a route of coin machines and earn amazing profits. 32-page catalog free. Parkway Machine Corporation, Dept. 72, 715 Ensor St., Baltimore 2, Md.

HAVE Home mail business—Get \$10 orders in every mail. Keep \$8.00. Everything furnished. Hutchinson, 401-A Adams, Dorchester 22, Mass.

BOOKKEEPERS. Keep books, small firms spare time. Manual latest technique by C.P.A., \$3.00. Modern Business, Box 406, Youngstown 1, Ohio.

BRONZED Baby shoe supplies, instructions, mountings. Metal bookends. \$1.50 pair. Free catalog. National Bronze Supply, Box 56, Los Angeles 32, Calif.

QUICK Money! Repairing car batteries. At home! Easy, too! Batteryman, Grand Junction, Colorado.

MONEYMAKING OPPORTUNITIES

MINIATURE Trees. Why pay \$2.00, \$5.00 for growing secrets? Free details. Bassett, Dept. R, 5033 N. Winthrop, Chicago 40.

BUY Wholesale. Thousands nationally advertised items. Save, make money! Free details. Durex Co., Box 872-R, Chicago 90, Ill.

285 WAYS To make money at home. Information free. Virilio, Box 597-2, North Hollywood, California.

DON'T Be Mr. Average Man. Operate your own business. Very desirable, non-perishable, no chemicals or liquids, highly profitable. Write for details. Protecto Products Company, Box #543, Oak Park, Illinois.

FLEXIBLE Rubber moulds for plaster and Marble figurines. Sample and large illustrated catalog 25c. refunded on first order. K-C Novelties, Dept. 4, Easthampton, Mass.

GROW Mushrooms. Cellar, shed, and outdoors. Spare, full time, year round. We pay \$3.50 lb. We paid Babbitt \$4,165.00 in few weeks. Free book. Washington Mushroom Ind., Dept. 173, 2954 Admiral Way, Seattle, Washington.

CHINCHILLAS: Profitable. Raise in spare room, cellar, Ross Chinchilla Ranch, 749 Rincon, El Sobrante 11, California.

SPARETIME Profits taking subscriptions, all magazines. Wholesale catalog free. Cassell Agency, Westfield 2, New Jersey.

EARN \$50.00 Daily making mats, shoes and mud guards from old tires. S and S Patents Inc., 1307 North Clark St., Chicago 10, Ill.

SELL Titania gems; \$9.75 carat wholesale. More brilliant than diamonds. Free catalogue. Diamonite, 1404-M Mitchell, Oakland 1, California.

50,000 ARTICLES Wholesale. Source directory, dime. Nelko, Box 3462-DR, Chicago 54.

SCHOOL Seniors—Sell classmates America's most beautiful graduation name cards. Largest selection. Highest commission. Outsell all others. Free sample kit. Printer, Dept. M, 1509 Maple Street, Scranton 5, Penna.

READ Progressive Mailtrade, the magazine that tells how to make money by mail. Dime brings sample and special offer. Progressive Mailtrade, Box 357, Sheboygan, Wisconsin.

FREE Book "506 Odd, Successful Businesses". Work home. Expect something odd! Pacific, Oceanside, Calif.

137 PLANS To make money, local mail-order. Details: Elite Co., 220 Grand St., New York 13.

PUBLISH Your own magazine. Handsome 52 page format, well edited, illustrated. Cost low as \$1.00 month. Brings you prestige, profits. 25c brings sample, details. National, Ord, Nebr.

GENERAL Contest Bulletin. Issued monthly. Sample, 10c. 1609 1/2 East 5th, Duluth, Minn.

MAKE To \$4.50 hour doing common pen lettering. National Artists, 801 1/2-A North Marsalis, Dallas 3, Texas.

WINNING Prize contests is fabulous, confidential, home opportunity! Send stamp! National Contest Bulletin, Box 2685-P, Miami 16, Florida.

BOX Tops, wrappers, labels, coupons worth money! Details 10c. Sale-Mail Co., 237 East Broadway, New York City 2.

100 MONEY-Making plans, formulas, and ideas. Amazing new book, just off press. Only one quarter. Address Leashan, 3319 West 11th Street, Cleveland 11, Ohio.

\$10,800 PROFITS! Your own mailorder business! No risk! Success plan free! Treasury, 709 Webster, New Rochelle, PM-21, N. Y.

COST Of things going up faster than your income? You can make more full or part time as a Rawleigh dealer. Write for full particulars. Rawleigh's, Dept. C-RR-PPM, Freeport, Ill.

"HOW To Make Money with Simple Cartoons"—A book everyone who likes to draw should have. It is free; no obligation. Simply address Cartoonists' Exchange, Dept. 93CM, Pleasant Hill, Ohio.

START A profitable subscription business in spare time! We need men and women (young or old) as representatives for all leading national magazines. Liberal commissions paid for new and renewal subscriptions. Start earning money in this pleasant work at once! Clip this ad and send with your name and address to: International Circulation Distributors, Dept. PM, Hearst Magazines, 250 W. 55th St., New York 19, N. Y.

OPERATE Cafe, diner, without penny invested. Will help you locate. Free details. Restaurant Arts, 53-M, Fremont, Ohio.

SHINE Cars without polish. New invention. Lightning seller. Cars gleam like mirror. Samples sent on trial. Kristof 101, Akron, Ohio.

EARN Over \$100 a week from your home, part-time or full-time, renewing small auto part for wholesale trade. Exclusive, non-competitive. No machinery or skill required. No sales calls to make. Complete data and sample 35c. Merriam Sales and Service Co., Dept. PM3, 3500 Merriam Lane, Merriam, Kansas.

CYPRESS Knee lamp kits \$3.95, postage 50c. Cy Products, Dept. 1-A, Lafayette, La.

OPERATE Profitable mail order business. Write N. Bode, 223 So. Jefferson, Canonsburg, Penna.

BECOME Patent firm representative. Spare time, mail order. Experience unnecessary. Work done Washington office, you receive sensational income! Industrial Patent Reports, Box 6296, Washington 15, D. C.

MAKE Money at home—Mailing literature to new mothers. Big profits. Everything furnished. Alan Blaesing, 1116—131th Street, Racine, Wisconsin.

START Silverware renewal service. Franchise. Exclusive. NuSilver, 508-PM3, Aurora, Illinois.

BE Appointed. Outfitted. Notary public. Thousands needed. Men. Women. Box 3025, Dallas 1, Texas.

TYPEWRITER Owners. Make handsome profits. Get details today. Groves Company, 682, Hastings 3, Nebraska.

FREE Information. Start your own business for \$1. Ide, 23 Robbin Hill Rd., Scarsdale, N. Y.

CASH-In. Get into mail order business. 68 page book reveals business secrets, effective advertising, what to sell, beginners advice. Numerous tested and original money-making plans. Over 40,000 words. We'll include other helpful literature free. Rush 25c to: Par Products, 2185 Bolton St., New York 62, N. Y.

MANUFACTURER—Wants reliable men-women for profitable mail order work. Home. Sparetime. Liebig, Beaver Dam 4, Wisconsin.

ADDED Income selling by mail. Roblin Sales, 1001 Curtiss, Downers Grove, Ill.

ANOTHER \$50 Raise! Simple! \$1.00 booklet tells how! Sparks, Box 4871, Anadarko, Oklahoma.

FOREIGN Employment construction work. If interested in foreign projects with high pay write Foreign Service Bureau, Dept. PM, Metuchen, New Jersey.

EARN Money evenings, copying and duplicating comic cartoons for advertisers. Adservice, Argyle 1, Wisconsin.

SELL Books by mail. Literature free. Royal, Box 368-A, Cleveland 27, Ohio.

FREE! "301 Profitable Small Businesses!" Amazing shoeing plans! Work home! Start sparetime Deumant Surveys, Kenmore 23-PM, N. Y.

A GOLD Mine of information—Old Showman's Book of Secrets, \$1 postpaid. Supply limited. "Popcorn" Miller, 3525 South Cedar, Lansing 17, Michigan.

MAKE 300% Selling encyclopedias! Original investment only \$9.95. Send quarter for brochure, refundable. Pacific Research, Box 907, Phoenix, Arizona.

ADDED Income! That's why you're reading this ad. We invite you to write Milmac, 724 East 260, Euclid 23, Ohio.

PUZZLED About mail order? Get the inside "dope." Write: Levine, 137-A Riverside Drive, New York 24, New York.

START A buying service, buy wholesale thousands nationally advertised products. Make big profits selling at sizable discounts. Postcard brings details. American Buyers, 630-P Linden, Buffalo, N. Y.

400 RADIO Stations active. Free radio advertising. Pay commission only on orders received. Free information. Mishek, 1M, Waseca, Minn.

NEWEST Spare, full-time home business. \$5 to \$10 hour possible. Paint with suede—the finish with touch and eye-appeal. Beautify auto dashboards, signs, radios, toys, figurines, lamps—1001 others. Complete, step-by-step instructions sent for no-risk examination. Free details. Coast, 1604-RW So. Los Angeles St., Los Angeles 15.

MONEY Found. Be our agent in your community. Top quality watches, diamonds, jewelry, at wholesale prices. Amazing profits. Experience unnecessary. Send 25c for catalog. Refunded on first order. Zerach Brothers, 602 Mission Street, Dept. M3, San Francisco 5, California.

BE The Popular Mechanics representative in your neighborhood and earn big profits in your spare time. Write Popular Mechanics Magazine, Room 408M, 200 E. Ontario St., Chicago, Ill.

FORMULAS. PLANS. ETC.

ANY Formula \$5.00. Satisfaction guaranteed. Jack, Consulting Chemist, 5138 Gainor, Philadelphia 31.

PRODUCT Analysis, manufacturing formulas, processes developed. Moderate fees. Plastics, Box 1574, Boston 4, Mass.

MILLER'S Modern manufacturing formulas make fast-selling products that get the business and pay! Fifty years supplying the best. Late literature free! Liscombe Miller, Chemist, Tampa, Florida.

500 MONEY Making formulas, 25c postpaid. Allen, Dept. PMC, Clinton, Missouri.

FORMULAS: All kinds. Latest, best. Literature free. Kemixal, Park Ridge, Ill.

GENUINE Manufacturing formulas. Latest. Literature free. Neiko, 3462-P Merchandise Mart, Chicago 54.

REAL Manufacturing formulas. Lists free. Cummings, Chemist, Gordon Ave., Syracuse 4, N. Y.

ANY Formula \$3.00. Chemical Instruction Sheet—catalog 10c. J. Belfort, 216 W. Jackson, Chicago 6.

FREE Formula catalog. Anything analyzed \$35. Western Chemical, Salem, Ore.

LABORATORY Tested formulas. Catalog free. Pont Chemical Company, Terre Haute 2, Indiana.

PLASTICS

PLASTICS Home-craft course for men and women. Tells and shows how to make hundreds of fast selling plastics products. All plastics and materials for 23 projects included in course. No special tools needed. Course pays for itself. Write for free booklet, Interstate Training Service, Dept. D-3-C Portland 13, Oregon.

NEW Liquid casting plastic. Clear, colors. Preserve flowers, insects, photos permanently. Saw, drill, carve. Send 25c for Castolite Casting Manual and proved success plan showing how to make money at home. Castolite, Dept. C-101, Woodstock, Illinois.

"PLEXIGLAS Craftsman Handbook." Exceptional new plastic manual, material catalog, \$1.00 postpaid. Plastics, Box 1812, Salt Lake City 10, Utah.

MONEYMAKING Liquid casting plastic. Starting kit \$3.00. Send 50c for complete handbook and information. Kennits Corporation, 2755 N. 5, Milwaukee, Wisconsin.

FIBERGLAS, Polyester, Plexiglas, Acetate, Vinylite. Casting, coating plastics. Maurice Lannon's Fiberglass "How" book now ready, \$2.50. Fast service, best prices. Catalog 10c. Airmailed 35c. Gem-O-Lite, Box 6867P, North Hollywood, California.

PLEXIGLAS Sheets—Cut to size. Clear. All thicknesses. Standard outdoor translucent colors. McClarin Plastics, P.O. Box 164H, Hanover, Penna.

PLASTICS, Cements, dyes, findings, carvings. Wholesale prices. 64 page catalog free "Trace and Carve" pattern book for carving and coloring fish, birds, animals, only 35c. Taylor & Art, Inc., 1710 East 12th Street, Oakland 6, California.

LEARN Plastics at home. Complete kit—\$5.98 postpaid. Dime brings sample plastic, three experiments, full details. Plastic Projects, Box 5151, Detroit 35, Mich.

PLASTIC, Sheets, rods, tubes, etc. Free list. Plastic Supply Co., 2901 N. Grand Blvd., St. Louis 7, Mo.

PLEXIGLAS, Lucite. Any size sheets. Square foot (12 x 12) cost, 1/16", \$1.18; 1/8", \$1.55; 3/16", \$1.90; 1/4", \$2.25. Add 15% for postage. Minimum order \$3.00. Almac Plastics, 600 Broadway, New York City.

NEW! "100 Best Woodworking Projects"—144 page Popular Mechanics book with 100 special projects for every member of the family. Furniture, toys, novelties, many more. Send \$2.00 to Popular Mechanics Press, Dept. 105, 200 E. Ontario, Chicago 11, Ill.

CHEMISTRY

CATALOG, Bargain lists, 20c. Laboratory Sales, Box 161-A, Brighton, Mass.

IMPROVED Second printing. "Spectacular Chemical Experiments" manual. Not mimeographs. Concise yet thorough. Contains complete formulas, set-ups, instructions, special data, on thermites, fulminates, acetylides, explosive powders, etc. Only \$1.00 postpaid. Chemi-Technix Laboratories, 583CR Riley, Buffalo 8, N. Y.

DO Your own analysis and chemical separations. Laboratory analytical ion exchange column. Apparatus complete with cation, anion resins, instructions, \$4. Rainway Chemical Company, 800 Delaware, Berkeley, California.

AMAZING New Book of Science. Experiments, formulas and catalogue of laboratory supplies. Only 25c. National Scientific Co., Dept. 16, 2204 W. North Ave., Chicago 47, Illinois.

ILLUSTRATED Catalog: Chemistry, mineralogy, biology 30c. Tracey Laboratories, Evanston, Illinois.

NEW Idea chemical and apparatus outfits for home experimenting. Photo-scales, microscopes, chemicals, biological and laboratory supplies in small quantities. Catalog 25c. Established 1931. John H. Winn, 124A West 23rd Street, New York, N. Y.

CHEMICALS And apparatus for industrial, analytical, and private laboratories. Catalog 25c. Dept. M-50, Biological Supply Co., 1176 Mt. Hope Ave., Rochester 20, N. Y.

AGENTS WANTED

SELL Adjustable, high-lifting, self-closing farm gate hinges. Magic Hinge, Bonilla, South Dakota.

FREE! "How to Make Money with Greeting Cards" booklet. Samples on approval. Organizations! Ask for fund-raising plan. Writewell, PM-43, Boston 15, Mass.

TERRIFIC Wholesale proposition! Cameras, appliances, giftware. Catalogue 50c (refundable). Dart, 3812M Atlantic Avenue, Brooklyn 24, New York.

AGENTS-Salesmen: Sell beautiful hand-colored plastic enlargements and sensational new personalized photo compacts, rings, bracelets, lockets, etc. Experience unnecessary. 40% advance commissions. We deliver, collect. Wonderful sideline—Better full time. Free sample outfit. Novel Portrait Co., 3343 North Ave., Chicago, Ill.

STRANGE Dry window cleaner. Sells like wild. Replaces messy rags, liquids. Simply glide over glass. Samples sent on trial. Kristee 51, Akron, Ohio.

PRINTING. Advertising salesmen—Excellent money-making sideline selling decalcomania name plates, small quantities. Automobile initials, sign letters. Free samples. Balco, XL, Boston 19, Mass.

AGENTS—Show America's leading nationally advertised line. Novelties, gifts, utility items. 100% profits. Prospects everywhere. Steady repeats. Write today for sensational low prices, free literature. Charms & Cain, 407-PM-34 South Dearborn, Chicago, Ill.

BEAUTIFUL Feather pictures. 200% profit! Free sample. Apartado 9036, Mexico 1, D. F.

MAN Wanted—Are you dissatisfied with your work? Would you like a business of your own? If so, write Rawleigh's, Dept. C-GG-PPM, Freeport, Ill.

MEN-Women: 100% profit, taking orders for Sweet Georgia Brown beauty products. Colored people buy on sight. Sample offer. Valmor, 2451-BH Michigan, Chicago 16.

MAKE Money introducing world's cutest children's dresses. Big selection, adorable styles. Low prices. Complete display free. Rush name. Harford, Dept. L-4341, Cincinnati 26, Ohio.

CLEANS Walls without dough. New invention. Lightning seller. Walls gleam with brightness. Samples sent on trial. Kristee 54, Akron, Ohio.

BIG Profits selling ties (\$2.00 values), \$6.50 dozen. Free catalog. Empire Cravats, 611A Broadway, New York 12.

BUY Wholesale. 25,000 items. Catalogue 25c. Matthews, 1472-B6 Broadway, New York City 36.

101 DIFFERENT Ways to make extra money! Sell "lifelike action" greeting cards. Make \$50, \$75, \$100, more. Win famous products as bonus. Write for feature all occasion assortments on approval. Free samples name imprinted stationery, free color catalog, selling guide. New England Art Publishers, North Abington 333-A, Mass.

RUN A spare-time greeting card and gift shop at home. Show friends samples of our new 1954 all-occasion greeting cards and gifts. Take their orders and earn up to 100% profit. No experience necessary. Costs nothing to try. Write today for samples on approval. Regal Greetings, Dept. 157, Ferndale, Michigan.

LIFETIME Vitamin business! Terrific profits! Earn \$50 weekly spare time. National Health Products, 150 Broadway, Dept. MP-2, New York 33.

WINDOW Sign letters. Samples free. West Coast Sign Letter Service, P.O. Box 697, Escalon, Calif.

WHOLESALE Catalog nationally advertised appliances, cameras, watches, etc. Send today for free information. Carroll Distributors, 4421 Snyder Ave., Brooklyn 3, N. Y.

CALIFORNIA Sweet smelling beads. Sensational sellers. Free particulars. Mission, 2328PM West Pico, Los Angeles 6, Calif.

SPARE Time money plus new car as encouragement bonus. Amazing 60 gauge nylons 3 pairs guaranteed 3 months. Write Wilkmit, 1743 Washington, Greenfield, Ohio.

NEW Item, everybody carries. Cost 8c. Sells 25c. Sample 25c. Weigand, Graham, Florida.

FREE Plan. Own a business: exclusive sales. We supply product, private labels, literature; you furnish, execute management and employ salesmen. Terrific profits. Automatic repeats. Write today. VitaMins, 2908PMA Beverly, Los Angeles 57.

AGENTS. Salespeople, distributors. Cash in now with fastest-selling \$1.00 retailer we've ever seen. It's the "Senorita Van-Purse," ladies' billfold with built-in mirror, comb and emery board. Features also picture album, gusset change purse and key chain! Tremendous Christmas potential! Complete line includes many styles inexpensive men's, ladies, billfolds. Commissions to 40%, and everything sold on money-back guarantee! Rush card, letter today for sample on approval and complete sales plan. Modern Sales, 71-30 Fanshew, Yonkers, N. Y. P.S. Attractive over-ride available for crew managers, distributors and store-to-store salesmen. P.P.S. Attention overseas readers. This line is fabulous for export! Airmail, cable your inquiry today! Cable address Modern-cards, Yonkers, N.Y.

AGENTS Sell rich looking 34 by 66 imported Japanese rugs for \$3. Never before such a large rug for so low a price. Multi-color stenciled designs. Hooked, oriental and carpet patterns. All rugs delivered. Sample \$1.25, 4 or more \$1 each. E. Condon, Box 204, Upper Darby, Penna.

AMAZING Bath sponge. Washes back easily. Suds as it washes. Uses soap scraps. Big profit. Whirlwind seller. Write for free sample offer. Magica Products, Wollaston 70, Mass.

PERFUME—Sell nationally advertised imported base Parisian perfume. Send \$2.00 for sample worth \$15.00 and selling plan. Star Merchandise, Belmar, N. J.

BUY Wholesale from nationally advertised manufacturers, distributors. Literature free. Carter Publications, Box 6011-L, Chicago 30.

MEXICAN Feather pictures. High profit! Fast sellers! Adelphi, Box 67-B, Bellefonte 26, N. Y.

NEW Product. Sample, details free. Prevette, 1200 Grover, Johnson City, Tenn.

40% PROFIT. Power mowers. Self-propelled. Sell on terms. Farmco-51, Excelsior Springs, Mo.

BALL Pens \$10.00 gross, retractable pens \$2.50 dozen. Needlebooks with threader \$6.25 gross. Lutzker, 871F East 170th, New York City.

FREE Hosiery! Sensational new way earn to \$3 hour in spare time! Introduce amazing hosiery by giving away free pairs to every man and woman (regardless whether or not final purchase is made) just to prove how good they are! Wonderful luxurious nylon stockings, guaranteed against runs and snags, nationally known, sold coast to coast. New miracle one size two-way stretch men's nylon hose, contains no elastic, yet fits every size foot from 9 to 14! Never sags or droops, clings to foot like second skin. Outlasts several pairs ordinary hose and guaranteed one full year! Money or experience unnecessary. Buy nothing. Deliver nothing. Advance cash plus huge cash bonus to 40%. Your own hose as extra bonus. Special manager plan so you can appoint agents. Nothing like this ever offered before. Samples of stockings and miracle socks with complete money-making outfits free and prepaid. Nothing to pay now or later. Absolutely no obligation. Simply mail postcard with your name and address. Kendex, Babylon 23, N. Y.

A Dress-lingerie shop in your home. No investment. Good commissions. Write for sample book. Modern Manner, 260PA Fifth Avenue, New York.

BEST Source for nylons and men's socks. Rich Supply, 215 W. 98th, New York 23.

BUY Wholesale thousands nationally advertised products at big discount. Free "wholesale plan." American Buyers, 629-P Linden, Buffalo, N. Y.

EXTRA Money every week. I'll send you full-size Blair household products. Show them to friends and neighbors. You can make big extra profits. Write Blair, Dept. 31MC, Lynchburg, Va.

NINETY Percent successful mail order business depends on the article. The Five Star Wonder Tool is demonstrated on television for \$1.98. It sharpens knives, scissors, lawnmowers, etc., cuts glass. Send \$1.00 for two samples; doz. \$5.00. We pay postage. Gross \$48.00, one third cash, bal. c.o.d. Albert Cahill Steel & Iron Wks., Adams Ave., Toms River, N. J.

SELL Wholesale nationally advertised merchandise. Your own business easily developed. Catalog, details—\$1.00 (refundable). Bergen Novelty Sales Co., Dean St., Englewood, New Jersey.

MEXICAN Feather pictures. \$1.25 stamps brings \$2.50 worth samples. Aztec Art, Apartado 762, Mexico City.

BIG Profits. Razor blades, other items. Free sample, lists. Hansen Sales, 4908 Ohio, Chicago 44.

SELL: Watches, jewelry, household, gift items, national named brands. Guaranteed. Illustrated catalog and confidential wholesale price list 25c, refundable. H. Distributors, Paintine 5, Ill.

GOLD Or silver letters, numbers. Windows, doors, trucks. 1" to 6". 500% profits. Free samples. Atlas-T, 544 West 79th, Chicago 20.

UP To \$10 per hour. Full or part time, selling Ortho-Vent Spring-Step cushion shoes. High commissions, cash bonuses and exclusive repeats build you profitable business guaranteeing security. Free sales kit. No experience or investment needed. Write now: Ortho-Vent Shoe Company, Inc., Dept. PM-24, Salem, Va.

RID-O-Waste. A necessity for septic tanks, cesspools and outdoor toilets. Double your money. Details and sample 75c. Rid-O-Waste, Meredith, N. H.

BARGAINS. Job lots, close-outs! Save up to 50% on clothing, hosiery, notions, drugs, toiletries, gifts, jewelry, television, etc. 2000 items. 25c brings wholesale bargain catalog with special get acquainted offer which includes free \$1.00 merchandise certificate. Reliable Jobbers, 311-B North Desplaines, Chicago.

EASY Handwork makes fast-selling useful articles. Sample free. Sunmade Company, Brockton 84, Massachusetts.

EASY Extra income—Sell sensational new scorch resistant silicone ironing board covers. Good Housekeeping approved. Terrific \$1.98 seller! Send for free complete selling kit. Menell Products, Dept. P—P.O. Box 431, Midtown Station, New York 18, N. Y.

APPLIANCES, Cameras, radios, toys, typewriters, watches. Large coded wholesale catalogue! Cam Company, 6866PM—20th Ave., Brooklyn 4, N. Y.

MAKE Up to 150% profit selling finest line everyday greeting cards. New \$1.00 assortments, 21-card boxes, make-it-yourself kits, 100 fast-sellers. Extra gift bonuses! Assortments on approval. Stationery samples free! Creative Cards, 2505 Cermak, Dept. 502-H, Chicago 8.

PRINTING. Salesbooks, envelopes. Free illustrated catalog. Ercco, Dept. PM, Bronx 72, N. Y.

BE A money maker. Use your home as magazine headquarters. Liberal commissions. No experience—No capital needed. Everything furnished. Write for free catalog. McGregor Magazine Agency, Dept. 500 A, Mount Morris, Ill.

SAVE 50-75% On household appliances. Free particulars. Wholesale catalog. Nuebbings-P, Sicklerville, N. J.

SCHOOL Seniors—Have fun and spending money! Be popular with your classmates. Send postal for details. Craftcards, Box 235-L, Pittsburgh 19, Penna.

MAKE Extra money. Sell front door name plates to friends, neighbors. Retail \$1.98; you make \$1.00! Free selling kit. Modern Engraving Co., P.O. Box 194, Boston 14, Mass.

YOUR Own business—Used suits \$1.50, overcoats 65c, mackinaws 35c, shoes 12½c, ladies coats 30c, dresses 15c. Enormous profits. Catalog free. Moro, 538-AA Roosevelt, Chicago 7.

AGENTS: Stamping names on key protectors. Sample 25c. Stamping outfits, checks, social security and name plates. Hart Mfg. Co., 303 Degraw St., Brooklyn, N. Y.

AGENTS—300% Profit selling genuine gold window letters; stores and offices. Free samples. Metallic Sign Letter Co., 431-D North Clark, Chicago.

\$1.00 PROFIT Selling \$2.95 photo enlargement deal. Allen Studio, Riegler Bldg., Little Rock, Ark.

200 ONE-Evening Projects that you can start and finish in one evening! Popular Mechanics editors have assembled 200 projects to be made with only simple hand tools, in a few hours time. Each project costs only 1c. Order your copy today, \$2.00. Popular Mechanics Press, Dept. EP-2, 200 E. Ontario, Chicago 11, Ill.

SALESMEN—DISTRIBUTORS

SELL Miracle orlon embroidered work uniforms. Looks, feels like wool; wears 3 times longer and washes like cotton. Huge 3-foot wide "Panoramic" line makes sales easy. Amazing profits. Outfit free. Topps, Dept. 533, Rochester, Indiana.

BIG Money. Lifetime repeats. Guaranteed. Wonder Glaze, Bay Port T. Mich.

OXFORD. Most compact tie rack. Made in 3 sizes. Details free. James Products, 1625 So. 50th Ave., Cicero 50, Ill.

ADVERTISING Book matches—Cash in on big demand; sell union label matches. Cuts for all businesses and political parties. Free powerhouse selling kit, low prices, protection guaranteed on repeat orders. Cash commissions. Superior Match Co., Dept. M-354, 7530 Greenwood, Chicago.

BIG Money-making opportunity. Exclusive line work uniforms. Jackets, pants, shirts, coveralls. Advertising embroidered. Every business prospect. Outfit free. Master Div., 152 Water, Ligonier, Ind.

CALENDARS. Advertising novelties, matches. All styles, including religious, varnished, 12 sheet, girls. Hundreds of advertising novelties, book matches, etc. Fleming Calendar Co., Sales Division, 6539 Cottage Grove, Chicago 37, Ill.

AMAZING Discovery. Master Glaze, puts brilliant glass-like surface on cars. Free sample, information. Big commissions. Master Glaze, Dept. 735, 7720 Harwood, Milwaukee, Wis.

A Postcard can put you in a fine business! Complete line of air cushion shoes. Big steady commissions. No experience or investment needed. Send postcard for free outfit. Mason Shoe Mfg. Co., Dept. MC-2, Chippewa Falls, Wisconsin.

\$10,000 PROFIT Selling printing, matches, specialties! Arrow dealer tells how he did it in giant free sales outfit. You can do it too—Without experience. Write Arrow Press, 515-D Fourth Ave. So., Minneapolis, Minn.

ANYONE Can sell famous Hoover uniforms for beauty shops, waitresses, nurses, doctors, others. All popular miracle fabrics—Nylon, dacron, orlon. Exclusive styles, top quality. Big cash income now, real future. Equipment free. Hoover, Dept. C-100, New York 11, N. Y.

AD Matches! Sell amazing designs—20, 30, 40 and 240-light book matches. Bigger spot cash commissions; every business a prospect. Low prices for high quality. Repeats. Start without experience; men, women; full, part time. Buy nothing! Sales kit furnished. Match Corp., Dept. PM-31, Chicago 22, Illinois.

DOORS, Folding leatherette, Compact space savers. Enormous potential. Retail, wholesale. Information, fabric samples, 25c. Regal Door, 312 E. Main, Kent, Ohio.

GET New shirt outfit free; make \$90.00 weekly on 5 average orders a day. Fashion quality made-to-measure dress and sport shirts at \$3.95 up sell fast to all men. No experience needed. Full or part time. Write: Packard Shirt Co., Dept. 620, Terre Haute, Ind.

IS \$210 A week worth a postcard to you? Then rush card with name and address for special free trial plan that sells amazing new automatic refrigerator defroster like hot cakes! Write to Mr. Lewis, D-Frost-O-Matic Corp., Dept. M-102, 173 W. Madison, Chicago 2, Illinois.

SALESMEN—\$50.00 In a day definitely assured, selling brand new item going to every type of food and beverage store, factories, laboratories, hospitals, etc. Samples furnished. Utility Durawear, 53 West Jackson Blvd., Dept. PM-3, Chicago, Illinois.

NEW Chemical discovery. Pro Auto Wax, easy way to car beauty. Free sample, information. Amazing profits. Burford Auto Finishes, 1660—20th Street, Santa Monica, Calif.

ADD New line: Rubberized nylon shopping bags. Big returns. Assured re-orders. Fremont Bags, Brighton 35, Mass.

BUY Wholesale thousands nationally advertised products at big discount. Free "wholesale plan." American Buyers, 630-D Linden, Buffalo, N. Y.

SELL Perfume wholesale. Billows, 110-05 37 Ave., Corona 68, N. Y.

NEW Jobs open in selling. Send name, address for five free issues of Opportunity Magazine's money-making guide. Listing hundreds of companies who'll pay you well, full or part-time. No experience needed. Opportunity, 28 E. Jackson, Dept. 17, Chicago 14, Ill.

MAKE Money with fast-selling Bostonian shirts. Spare time, full time. Sales kit, actual sample fabrics, free. Bostonian, 89 Bickford, Dept. D-10, Boston 30, Mass.

MEN Wanted to sell our established line of nationally known men's hygienic products to physicians and druggists. Extremely long profits. Many ready customers waiting for our salesmen. Free price list upon request. Send \$2.00 for salesman's sample kit including actual samples and prices of merchandise to be sold. Federal Premium Supply, 4307-J Lawrence Ave., Chicago 30, Illinois.

EDUCATIONAL AND INSTRUCTION

OPERATE A collection agency business. Very profitable. Easily learned. Write Cole & Associates, Syracuse 2, N. Y.

LEARN Priceless secrets of technical metaphysics. Easy to learn. Only school of its kind. Write: Premier College of Technical Metaphysics, 2532 McKenzie St., Vancouver, B. C., Canada.

IT'S Fun learning a language by Linguaphone. At home, quickly, easily learn to speak French, Spanish, German, Russian, Japanese—29 languages by Linguaphone World's Standard Conversational Method. It's like living in another country. Save time, work, money. Send for free book. Linguaphone Institute, 8303 RCA Building, New York 20.

COMPLETE Your high school at home in spare time with 57-year-old school. Texts furnished. No classes. Diploma. Information booklet free. American School, Dept. X345, Drexel at 58th, Chicago 37, Illinois.

INVESTIGATE Accidents—Earn \$750 to \$1000 month. Thousands of insurance companies, airlines, and steamship lines urgently need claim investigators. We train you at home spare time. Placement counsel and help. Free book, now! Universal Schools, Dept. 103, Box 8202, Dallas 5, Texas.

WANT A diesel job? New opportunities to increase income. Higher pay. More money. We can help you qualify. Tools, Shop method home training. Write today! Diesel, Tractor, Heavy Equipment Division, Interstate Training Service, Dept. B3-C, Portland 13, Oregon.

OIL Coloring photographs—A fascinating hobby or profitable sideline for those with artistic talent. Learn at home. Easy simplified method. Free booklet. National Photo Coloring School, 835 Diversey Parkway, Dept. 3432, Chicago 14.

HIGH School—No classes. Study at home. Spare time. Diploma awarded. Write for free catalog HF-41, Wayne School, 2527 N. Sheffield, Chicago 14, Ill.

LEARN Auctioneering. Our method quicker. Nelson Auction School, Renville, Minnesota.

BLUEPRINT Reading—Train at home. Learn to read blueprints with confidence in 10 easy lessons. Write today Belton School, Dept. M, 1059 N. Lawndale Ave., Chicago 51, Ill.

LEARN Character analysis from handwriting. Hobby, profession. Details free. Howell, P.O. Box 352, Santa Ana, Calif.

CORRECT Your thinking and change your life! Write Christian Way of Life School, Box 7B, Main Office, Louisville 1, Kentucky, U.S.

BOOKKEEPERS—Operate profitable "no-ledger" bookkeeping and tax service. Write, Frye, Box 432, Chester 1, South Carolina.

ABC Shorthand \$2.00, returnable. Zinman, 215-P West 91, New York 24, N. Y.

U.S. Government and trade jobs. Inexpensive, complete home preparation. Sample tests. Free catalog. Federal Institute, 304F Chestnut Street, West Hempstead, N. Y.

SIGN Painting. Learn easy. Instructions \$2. Information free. John Blackwell, Inverness, Florida.

LEARN Real estate business. Brokers earnings often exceed \$10,000 yearly. Easy home-study course covers all subjects. Special emphasis on how to show and sell property. Lowest cost, easy terms. Write for free literature. Seavy Realty Institute, 1750 Colorado Blvd., Los Angeles 41, California, Dept. M.

DO You know how to obtain a job? Employment instructions, type places to apply, conduct at interview, sample application (ad answers) letters, etc. Mail \$1.00. Royal Wilson, Box 1924, Jacksonville, Fla.

CORRESPONDENCE Courses, books, rented, sold, bought. Catalog free. Magnolia Press, Box 1273-F, Burbank, Calif.

WELDING Training pays at Hobart Welding School, Box M-341, Troy, Ohio. VA contract. Best equipment. Catalog free.

UPHOLSTERING—Train at home for prosperous business. Tools, supplies sent. Illustrated training shows you—previous experience unnecessary. Establish full or part time business. Free booklet explains plan. Write Commercial Trades Institute, 1450 Greenleaf, Dept. U2A-3, Chicago 28.

PIANO Tuning pays. Learn this profitable profession at home. Our Tonometer and mechanical aids make learning easy. No knowledge music necessary. Diploma granted. Largest and oldest school—36th year. G.I. approved. Write for booklet. Niles Bryant School, 78 Bryant Bldg., Washington 16, D. C.

STRUCTURAL Drafting. Materials furnished. Free booklet. Roth Tech, Box 2283, Youngstown 4, Ohio.

WAKE Up your mind. Be what you desire. Free "know how" lecture and exciting home-study details may be had by writing Applied Christian Psychology, Inc., Box 1924-E, Louisville 1, Ky.

WANT U. S. gov't. job? 350,000 openings yearly! Start high as \$318 month. Men-women, 18-55. Qualify now! Experience often unnecessary. Get free 36-page book showing jobs, salaries, sample tests, opportunities. Write: Franklin Institute, Dept. L-24, Rochester, N. Y.

BE A real estate broker. Study at home. Write for free book today. G.I. approved. Weaver School of Real Estate, 304 Law Bldg., Kansas City, Missouri.

HIGH School diploma at home. Licensed teachers. Approved materials. Southern States Academy, Box 144-MX, Station E, Atlanta, Georgia.

IDEAL Mail order home study course. Particulars free. A. Spencer, Mokena, Ill.

FINGERPRINTING Course, \$12.00, details. Alabama School of Fingerprinting, 414 South 10th Street, Bessemer, Alabama.

STUDY By correspondence for doctor's degree in psychology, metaphysics and divinity. College of Divine Metaphysics, Dept. P-M, 2811 North Illinois St., Indianapolis 8, Indiana.

A College B.A. and M.A. degree by home study. State chartered. Fremont College, 915 Grand View St., Los Angeles 6, Calif.

INCREDIBLE! Become mental superman overnight! Free booklet! Bijou, Box 1727-ME, Hollywood 28, California.

GROW Mushrooms. Cellar, shed, and outdoors. Spare, full time, year round. We pay \$3.50 lb. We paid Babbitt \$4,165.00 in few weeks. Free book. Washington Mushroom Ind., Dept. 174, 2954 Admiral Way, Seattle, Washington.

SECRET Investigation. Experience unnecessary. Investigators particulars free. George Wagner, M125 West 86th, New York 24.

LEARN Drafting—Write for free booklet, "Drafting Opportunities in Industry." Cesco Industrial Training Services, 1704-A Frederick, Fort Worth 7, Texas.

MIDLAND Linotype School. Charles City, Iowa. Civilian and Veteran Courses. Free placement. Established 1909.

EARN While you learn. Auto and diesel mechanics master this top paying trade. Many graduates earn \$100 a week and up. Information for Korean veterans. For free information write Dept. No. 256, Nashville Auto-Diesel College, Nashville 3, Tenn.

BOOKKEEPERS! Increase your earnings! Operate your own simplified "Dollar-A-Week" bookkeeping and tax service. Full or spare time. Details free. No obligation. Ellis, Box 200, Cedar Grove, North Carolina.

MEDICAL Laboratory technicians in great demand. We train you in your own home. Catalogue free. Imperial Technical Institute, Box 973-J, Austin, Texas.

INVESTIGATOR Training. Phillips Secret Service System, 1917-B North Kenneth, Chicago 39.

USED Correspondence courses and books sold and rented. Money back guarantee. Catalog free. (Courses bought.) Lee Mountain, Pisgah, Alabama.

GOVERNMENT Position! Home training for examination. \$9.95. Refunded if don't pass. Write, Ozmest Instructions, 34-CS, St. Louis, Mo.

SIMPLIFIED Analytics teach algebra instantly; \$1.00, guaranteed. Ziembek, 6123 Orchard, Dearborn, Mich.

PLAYS, STORIES, MANUSCRIPTS

JOKE Writing. I show you how. Nationally known radio show said work had "exceptional merit." \$2.00. Richard Bruce, 1530 N.E. 10th Ave., Portland 12, Oregon.

NEW Writers can earn \$1.00 to \$200.00, offered daily. Easy, spare time, home-work. Experience unnecessary. Details free. Writer's Institute, Sumner Road, Colorado Springs, Colo.

HOW To write short stories, mysteries, articles. Learn at home for career or extra part-time income. Graham Doar sold one story to Post, CBS radio and NBC-TV. Professional writers show you how. Send today for free lesson. Palmer Institute of Authorship, Desk TM-34, 1680 N. Sycamore, Hollywood 28, Calif.

ORIGINAL Musical comedy play. Unique, hilarious. Reginald Belcher, Cummington, Massachusetts.

I Want new writers—Experience unnecessary. Earn at home, spare time. Details free. Saunders Cummings Institute, P.O. Box 17007, Studio C-11, Los Angeles 17, Calif.

BEGINNING Writers: Get \$1 to \$30 checks daily writing simple children's stories, articles, poetry in your sparetime. Experience unnecessary. Our instructions reveal how. Details free. W. Herman, 5927 Euclid, Cleveland 3, Ohio.

NO Luck finding a book publisher? Write for free booklet PM. Vantage Press, 120 W. 31, New York.

BUSINESS SERVICE

BIG Profits for you. Small merchants, business men, collect past due accounts yourself. Use new 1954 collection manual. Shows procedure, plus collection letters. Results guaranteed, \$1.00 for limited time. The David-Marysue Company, Box 483-P, Grand Island, Nebraska.

SPECIAL SERVICES

REMAILS Southern California and Mexico 25c. Write other services. Purdy, 206 West Robinson, San Diego.

LOS Angeles, Beverly Hills, Hollywood, Calif. Letters remailed 25c. Chapple's, 9793 Anzac, Los Angeles, Calif.

LETTERS Rемаiled from Reno, "biggest little city in the world" 25c, 5 for \$1.00. Local classified ads airmailed \$1.00. Other services. Elmore's, 1455 Wesley Drive, Reno, Nevada.

EXTRA Special services. Remail Service, 4560 North 14th Street, Omaha, Nebr.

INFORMATION. Any matter. Ferguson Research Specialists, 116-14 141 St., South Ozone Park 36, N. Y.

CANADIAN Remails 25c, questions answered \$1. Artic Information Agency, Wabowden, Manitoba.

PROMPT. Reliable information on any subject. Questions on matters of fact answered, \$2.00 each. Gordon Research, Box 1427, Chicago 90.

LETTERS Rемаiled 25c, business investigations \$5.00. York Co., Columbian Tower 3, Memphis, Tenn.

PHOTOSTATS Up to 8 1/2x11 25c each, cash with order. Returned postpaid. Golub, 8335 23rd Ave., Brooklyn 14, N. Y.

VENEZUELA Remail, letters airmailed \$1.00. J. Small, Aeroven, Apt. #165, Ciudad Bolivar, Venezuela.

CARTOONING, COMMERCIAL ART, SHOWCARD & SIGN PAINTING, TATTOOING

COMPLETE 46 Lesson drawing course and 30 lesson cartooning course, beginners kit. All for \$2.49. Money refunded if not satisfied. Postcard brings full details. Woodbridge Sales, 1048 Taylor Ave., Scranton, Penna.

"HOW To Make Money With Simple Cartoons"—A book everyone who likes to draw should have. It is free; no obligation. Simply address Cartoonists' Exchange, Dept. 93C, Pleasant Hill, Ohio.

DRAW For comic books! New, specialized course by two of country's top comic book artists! Unique instruction covers both cartoon and realistic drawing. New! Different! Send \$1.00 for complete first lesson or ask for free information. Scholar Institute, Dept. PM-1, 3100 Cavendish Drive, Los Angeles 64, California.

\$130 FAMOUS Art course sacrificed, printer's over-run, only \$9.95 complete. Enjoy learning Life Art studies, cartooning, advertising, landscape, etc. New latest edition. Limited supply. Satisfaction or money back. Send \$1.00. Balance on arrival. Or enclose \$9.95, receive free \$5.95 Life Art, "Body Beautiful" 100 page book. Budd Sales, 918 St. Paul, Baltimore 2, Maryland.

TATTOOING Course, supply brochures 25c. Zeiss, 728 Lesley, Rockford, Illinois.

CHALK Talks. Laugh producing program, \$1.00. Catalog 10c. Balda The Cartoonist, Oshkosh, Wisconsin.

PAINT Signs and show cards. Biggest complete course with 324 illustrations (18 in colors) \$5 postpaid. Descriptive circular free. E. C. Matthews, 2325 Cass, St. Louis 6, Missouri.

ADVERTISING AGENCIES, LETTER WRITERS, FOR ADVERTISERS

EXPERT Mail order counsel \$2.00. Write. Copy-Craft, Box 62-P, Levittown, N. Y.

BUILD Your sales by recruiting productive agents, distributors, representatives, selling direct or to retail outlets. Secure most concentrated circulation through cheaper Opportunity Classified, 28-M East Jackson, Chicago 4.

FREE! 1954 Advertisers Rate and Data Directory, 52 pages! E. H. Brown Advertising Agency, 20 N. Wacker, Chicago 6.

FREE! 1954 Advertiser's Guide. Rates, ideas, publicity service. BT Nationwide Advertising Service, 2108 Payne, Cleveland, Ohio.

FREE Copy, layout service. Mailorder ad, 1,700,000 nationwide circulation, \$27.30 inch, 24-word classified, 20 big Sunday newspapers, \$30.00. Advertising ratebook free. Chicago Advertising Agency (established 1900), Chicago 4.

MAILING Lists, most any classification. 1000 names \$5.00. 1000 your circulars mailed with ours \$4.00. 5000 your circulars printed and mailed \$12.95. Write Dixie Mailers, King, North Carolina.

ADVERTISE: 24 Words, 100 Canadian newspapers \$5.50. Lists free. Advertising Bureau, 10511-C Springfield, Chicago 43.

ADS Placed in out of town newspapers and magazines. Low rates. Catalogue free. Ideas that pay. Baker Advertising Agency, Successors Ankrum Agency, 189 W. Madison, Chicago 2.

ADVERTISERS! Reach nearly 18,000,000 readers. 25 Sunday national key newspapers, 18 words, \$59.00. "Terrific pullers." 20 popular newspapers, \$11.50. Free booklet. Special—One inch display 2-821,198 circulation, \$51.10. Newmark's Advertising Agency, (Established 1893), 217-7th Ave., New York 11.

RUBBER STAMPS AND OFFICE SUPPLIES

RUBBER Stamps by professional craftsmen. 3 lines \$1.00. Price list. South Coast Press, 2128 Mt. View, San Bernardino, California.

THREE Line rubber stamp, self-inking pad, plastic case, \$1.00. Anderson, Box 855, Mountain Home, Tenn.

2 OR More at lower quantity prices. 4 lines \$1.00. Stamps, cuts, any kind. Catalog 10c refunded. Esco 34 Print, 8 Holt, Dayton 7, Ohio.

3 LINES, \$1.00. Fast service! Catalogue. Johnson Press, Box 6-A, New York City 26.

TYPEWRITERS, DUPLICATORS, OFFICE DEVICES

TYPEWRITERS; Adders; reconditioned; bargains. Catalog. Equipment, 2710 Tracy, Kansas City, Missouri.

QUALITY Duplicators—Rock bottom prices! Write, Paul Craig, North Wilkesboro, North Carolina.

44 PAGE Office equipment catalog, \$1.00 coupon, 25c. Homestead, Otsego 16, N. Y.

RECONDITIONED Typewriters, duplicating, printing devices, \$25.00 up. Supplies, Appliances, DixieGraph, King, N. C.

PRINTING, MULTIGRAPHING, MIMEOGRAPHING, GUMMED LABELS

DISTINCTIVE Printing. Samples, prices. Klifford, 545 North Oakland, Pasadena 4, California.

OFFSET Printing—Letterheads, envelopes, letters, forms, \$3.50 thousand. London, Box 1756, New London, Conn.

QUALITY Cards boost prestige and profit. Free samples. Bowden Printing, 7160 Allentown SE, Washington 22, D.C.

BEAUTIFUL Two color raised print business cards. Dignified, appealing. Send for samples, prices. J. Hampton, 601 1/2 N. Main, Wichita, Kans.

100 ENVELOPES \$1.00; 250, \$2.00. #10's, \$1.25, \$2.40 postpaid. Graphic, Manchester, New Hampshire.

BUSINESS Cards. Printing. Reasonable. Free samples. Lites, 5352-PM Princeton, Chicago 9.

50 SALESBOOKS Or 500 statements or letterheads \$3.00. Victor Press, Box 15-P, Dover, Mass.

100 PRINTED Letterheads or envelopes \$1.00. Two colors \$1.50. Broadbrook, Botsford, Conn.

1000 DISTINCTIVE Raised print business cards, \$3.95 delivered, 29 type styles. Samples free. A. O. Gerwig, Box 835, Columbus 4, Ohio.

BUSINESS Cards. Finest available. Samples. All-Trades, 304 Chestnut Street, West Hempstead, N. Y.

JOB Printing to suit your requirements. Send specifications for estimate, samples. Willcox, Nicholls, Ga.

150 BLOTTER Business cards, \$1.25. McIlvaine, Box 86-M, Brooklyn 30, N. Y.

WHOLESALE Prices. Quality printing. Free catalog, samples. Dealers wanted. Sutton Printing, Box 853-M, Waycross, Georgia.

BUSINESS Cards, 1000—\$2.50. Samples. Fuller's, 41 Brewster, Providence 6, R. I.

ATTRACTIVE Printing, stickers, labels. Inexpensive. Samples. Fame, 291 Ellis, San Francisco 2, Calif.

BETTER Printing—Reasonable prices. Free estimates. Samples. Reporter, Chelsea, Oklahoma.

100 ENVELOPES. Printed 2-colors \$1.25. Box 523, Rochester 2, N. Y.

100 8 1/2x11 LETTERHEADS, 100 6 1/2 Envelopes, \$2.00. 250 each, \$3.75. 500 business cards \$1.95; 1000, \$2.50. Standard copy. Postpaid. Allen, Dept. PMP, Clinton, Missouri.

MIMEOGRAPHING—Letters, price lists, formulas, instructions. Lowest prices. Lem's Letter Shop, 5710 Stanton, Detroit 8.

500 3/4x2 1/4 FOUR Line gummed stickers 50c. Red border \$1.00. Moritz Printery, Saginaw, Mich.

BUSINESS. Personal stationery. Catalogue free. Howprint, 723-M Eunice, Webster Groves 19, Missouri.

PRINTING OUTFITS AND SUPPLIES

JOB Printing, letterheads, envelopes, circulars. Printing, 21 Barclay, Portsmouth, Virginia.

BEAUTIFUL Art printed circulars—5,000, 5 1/2x3 1/4, \$8.95. 6 1/2x11 offset \$23.95. Free samples other printing bargains. Dixieprint, King, N. C.

FREE Booklet "Make Your Own Cuts," Amazing new system. Walp, Box 4308-M, Mobile, Alabama.

QUALITY Rule, leads, slugs. List free. Hamilton, 4341P Meade, Chicago.

MAKE Your own self-molding rubber printing cuts. Plexirubber, Argyle 1, Wis.

PRINTERS: Mini-fonts 45c each! Send for specimens. Edw. L. Eschinger, 2211 N. 2nd Street, Philadelphia 33, Penna.

PRESSES. Type, cabinets, supplies. List for stamp. Lincoln Press Company, 220-C Hartwell, Fall River, Mass.

PRESSES, Supplies, paper. Catalog 10c. Custom, Box 211-P, Springfield, Missouri.

DO Your own printing. Save money. Simple rules. We supply everything. Print for others; good profit. Raised printing like engraving too. Have home shop. Details free. Kelsey Presses, V-11, Meriden, Connecticut.

PRINTING Presses, type, supplies. Lists 3c. Turnbaugh Service, Loysville, Penna.

PATENT ATTORNEYS

CANADA—Ramsay Company Registered, 273 Bank Street, Ottawa, Canada.

"INVENTOR'S Guide" and "Record of Invention" free on request. Frank P. Ledermann, Registered Patent Attorney, 154 Nassau Street, New York City.

ALL Latin America, patents, trademarks, pharmaceutical licenses. Box 830, Lapaz, Bolivia.

PATENTS—Irving L. McCathran, 315 McLachlan Bldg., Washington 1, D. C. Registered Patent Attorney.

REGISTERED Patent attorney offers services. Sanders, 6430 Evans, Chicago 37, Ill.

INVENTORS: When you are satisfied that you have invented something of value write me, without obligation, for information as to what steps you should take to secure a patent. Write Patrick D. Beavers, Registered Patent Att., 935 Columbian Bldg., Washington 1, D. C.

PATENTS. "Proof of Invention" free. E. E. Vrooman, Registered Patent Attorney, 507 McKim Building, Washington 5, D. C.

INVENTORS: Without obligation, write for information explaining the steps you should take to secure a patent. John N. Randolph, Registered Patent Attorney, 203 Columbian Bldg., Washington 1, D. C.

C. A. Snow & Co.—M427, Snow Building, Washington 1, D. C. Registered Patent Attorneys. Write for information.

INVENTORS—For "Invention Record" form, contact Carl Miller, Registered Patent Attorney, Woolworth Building, New York.

INVENTORS: Learn how to protect your invention. Unless the inventor is familiar with patent matters, he should engage a competent registered patent attorney or agent to represent him. We are registered to practice before the U.S. Patent Office and prepared to serve you in handling your patent matters. "Patent Guide for the Inventor" containing detailed information concerning patent protection and procedure with "Record of Invention" form will be forwarded to you upon request—without obligation. Clarence A. O'Brien & Harvey Jacobson, Registered Patent Attorneys, 41B-A District National Building, Washington, D. C.

INVENTORS—If you consider your invention to be something of importance, take steps to protect it with a United States Patent which gives you the right to exclude others from making, using and selling your invention as claimed. "Patent Protection for Inventors" outlines steps to take to secure patent protection. Mailed promptly without obligation. Victor J. Evans & Co., Merlin M. Evans, Registered Patent Attorney, 931-C Meritt Building, Washington 5, D. C.

INVENTORS. If you believe you have an invention, you should find out how to protect it. The firm of McMorow, Berman & Davidson with offices in Washington, D. C., is qualified to take the necessary steps for you. Send for copy of our patent booklet "How to Protect Your Invention." We will also send you an "Invention Record" form. No obligation. They are yours for the asking. McMorow, Berman & Davidson, Registered Patent Attorneys, 1347 Victor Building, Washington 1, D. C.

FOR INVENTORS

INVENTORS—Send for free patent information book and inventor's record. Registered Patent Attorney, Associate Examiner, Patent Office 1922-29; Patent Attorney & Advisor, Navy Department 1930-47. Gustave Miller, 34A Warner Building, Washington 4, D. C.

INVENTORS—If you believe you have an invention, you should find out how to protect it. The firm of McMorow, Berman & Davidson with offices in Washington, D. C., is qualified to take the necessary steps for you. Send for copy of our patent booklet "How to Protect Your Invention." We will also send you an "Invention Record" form. No obligation. They are yours for the asking. McMorow, Berman & Davidson, Registered Patent Attorneys, 1346 Victor Building, Washington 1, D. C.

MY 7th Invention paid \$750,000.00. Others paid well. I learned the hard way what inventors should know, must avoid. My story tells all, can save you thousands, help you make fortune. Only \$1. Refunded if not delighted. Write Inventor, Post-Office Box 5, Station B, Omaha, Nebraska.

PATENT Searches \$5.00. 48-hour service. Free record of invention. Write Raymond L. Smith, Patent Searcher, 622 Sheraton Building, Washington 5, D. C.

SAVE Hundreds by making your own patent applications. Precise, practical, easy directions, including copy of author's actual application that was allowed patent in 7 months. Price \$5.00. Superior Inventions, 240 South Beverly, Beverly Hills, Calif.

COMPLETE Inventor's service. Reasonable rates. Write McCairns, Box 432, Detroit 31, Michigan.

INVENTORS—This firm is registered to practice before the United States Patent Office and is available to assist you in the preparation and prosecution of your patent application. "Patent Protection for Inventors" booklet containing detailed information and steps to take toward patent protection will be sent upon request. No obligation. Victor J. Evans & Co., 932-C Meritt Building, Washington 6, D. C.

PATENT Searches \$5.00. 48-hour airmail service. Record of invention forms free. Write Patent Engineering Service, 711 14th Street, N. W., Washington 5, D. C.

INVENTOR? My new book may save you thousands of dollars, hundreds of disappointments. 30 years experience, all phases. Patent attorneys, brokers, financiers. Condensed in crystal-clear instructions on what to do, what not to do. Case histories, examples, information available nowhere else, learned the hard way. Price \$5.00. Full information free. Claudius Neilson, Consulting Engineer, P.O. Box 4703-A, Detroit 19, Mich.

PATENT Searches \$5.00. Complete reports airmailed within 48 hours. Free invention protection forms. Write Miss Ann Hastings, P.O. Box 178, Washington 4, D. C.

IF You have more ideas than money, write David A. Lee, Box 53, Norfolk 1, Va.

FREE Help for inventors. Literature free. Grayland, 5312PM5 Grace, Chicago 41.

43 THINGS You must do before applying for patents. Fred G. Roth, 657 East 26 St., Brooklyn 10, N. Y.

MONEY From your valuable ideas! The International Inventors Club helps you patent and sell your inventions. Membership only \$15 year. Free information. 6614 Metropolitan Station, Los Angeles 55, Calif.

INVENTORS: Learn how to protect your invention. Unless the inventor is familiar with patent matters, he should engage a competent registered patent attorney or agent to represent him. We are registered to practice before the U.S. Patent Office and prepared to serve you in handling your patent matters. "Patent Guide for the Inventor" containing detailed information concerning patent protection and procedure with "Record of Invention" form will be forwarded to you upon request—without obligation. Clarence A. O'Brien & Harvey Jacobson, Registered Patent Attorneys, 41A-A District National Building, Washington, D. C.

PATENT Searches, \$5.00, including patent copies. Same reliable search as conducted for patent attorneys. Free protection forms. Patent Service Institute, 945-A Pennsylvania Avenue, Washington 4, D. C.

CASH For your idea. 280 manufacturers need inventions, patented or unpatented. List free. Invention Bureau, 208M Clinton, Oak Park, Ill.

INVENTORS—For "Invention Record" form, contact Carl Miller, Registered Patent Attorney, Woolworth Building, New York.

SEARCHES—Put your patent searches in the hands of a registered patent attorney or agent, as he qualifies to give a worthwhile patentability report. Record of invention form upon request and information on patent protection. Patrick D. Beavers, Registered Patent Attorney, 936 Columbian Bldg., Washington 1, D. C.

INVENTORS: Information on patent procedure furnished on request, without obligation. John Randolph, Registered Patent Attorney, 203 Columbian Building, Washington 1, D. C.

I Sell patents. Established 1900. Charles A. Scott, 773PM Garson Avenue, Rochester 9, N. Y.

INVENTORS: If you have an invention for sale, patented or unpatented, write Institute of American Inventors, Dept. 40A, 631-E St. N.W., Washington 4, D. C.

"**INVENTOR'S** Guide" and "Record of Invention" free on request. Frank P. Ledermann, 154 Nassau Street, New York 38, N. Y.

INVENTIONS WANTED

WE Buy or lease inventions and products if covered by patents or applications. Prefer wrenches, automotive devices, or electronic items. Durable Industries, 2128 Pittsfield Building, Chicago, Illinois.

INVENTIONS Needed immediately. Patented; unpatented. Free details. Kessler Sales Company, 53C, Fremont, Ohio.

INVENTIONS Promoted. Patented or unpatented. Established 1911. Write Adam Fisher Company, 5418 Idaho, St. Louis, Mo.

EFFECTIVE Invention marketing. Choice of terms. Inquire James G. Radtke, P. O. Box 854, Rochester, New York.

INVENTIONS Wanted. Patented, pending only. Inventors Patent Exchange, Hartford 1, Conn.

INVENTIONS Wanted. Patented; unpatented. Extensive manufacturers lists. Write Superior, 240 South Beverly, Beverly Hills, Calif.

PROTECTED Inventions wanted. Industrial Engineering Research Institute, 132 Nassau, New York City 38.

INVENTORS Don't sell your invention patented or unpatented until you receive our offer, write Cowgill, Box 298, Marion, Ohio.

INVENTORS: Hundreds of manufacturers have requested our assistance in locating marketable new products. Complete information free. Institute of American Inventors, Dept. 40-D, 631-E St. N.W., Washington 4, D. C.

INVENTIONS Wanted. Patented; unpatented. Tremendous manufacturers lists. Global Marketing Service, 1404 Mitchell, Oakland 1, California.

INVENTIONS Wanted. Patented or patent pending. 23 years experience promoting inventions. National Service Bureau, 3129 Meramec, St. Louis 18, Mo.

PATENTS FOR SALE

ADJUSTABLE—Scale ruling pen. Simple to manufacture, four part construction. Robert D. Shomo, 12968 Purdue, Detroit, Michigan.

U.S. Patent on "Word Forming Device." Canadian patent pending, for sale. Eric Janssen, 59-44 164th Street, Flushing 65, N. Y.

INVENTORS: Test the commercial value of your patented or unpatented inventions, quickly and inexpensively. Write for free information. Institute of American Inventors, Dept. 40-B, 631-E St. N.W., Washington 4, D. C.

MANUFACTURING

WE Design, develop, build, inventions, machinery, appliances. Henry, 2815 Blvd. Jersey City 6, N. J.

MODELS—Small lot manufacturing. Metals, plastics, etc. Milburn, Burlington, Kentucky.

MODELS, MODEL SUPPLIES

LIVE Steam engine, 10½" high, ready-to-run, \$5.95 postpaid. Catalog 35c. Merlo, 50-18 94th Street, Elmhurst 73, N. Y.

1954 **CAR** Models, 1/23 scale, all metal, chrome trim. Send for catalog. Cars & Hobbies, Dept. PM-16, 2333 Haddon, Chicago.

MICROMODELS. List for stamp. Jenid, 558 Loring Station, Minneapolis 3, Minn.

SHIP And yacht model fittings; blueprints. Send 25c for illustrated catalog listing hundreds of items. A. J. Fisher, 1003-1 Etowah Ave., Royal Oak, Mich.

FIBERGLAS Cover or build your model boats, planes, cars, etc. with miracle Fiberglass. Complete hobby kit and instructions \$3.00. United States Fiberglass-Resin Company, 722 East Washington, Los Angeles 21, California.

NEW Completely revised, giant 88-page 1954 "O" gauge catalog for model railroads. Scale and tinplate. Fully illustrated. Hundreds of car kits all types, steam locomotives, diesels, specialty items and parts galore. Catalog cost of 75c refunded with first \$5.00 order. All-Nation Hobby Shop, 182 N. La Salle St., Dept. A, Chicago 1, Ill.

BUILD Historic ships, vehicles. 50c to \$9.50 kits. Illustrated catalog 10c. Ideal Models, 21 West 18th Street, New York 11.

POWER Models. Unusual steam, gasoline and traction engines, fittings, metals. Anniversary catalog 50c. Chas. Cole, Ventura, Calif.

STEAM Locomotives, 1½", 1", ¾", ½", ¼" scales. Castings, rail, steam fittings! Thorough drawings with instructions. Catalog 50c. Little Engines, Wilmington, California.

SHIP And other scale models. Most complete line in New England. Kits, fittings, plans, books, tools, engines, motors. Illustrated catalog 25c. James Bliss & Co., Inc., Dept. SM, 342 Atlantic Ave., Boston 10, Mass.

BALSA Wood. Grade AAA. Free sample, price list. Sig Mfg. Co., Montezuma, Iowa.

HOME CRAFTSMEN

MODERN Bookcases, tables, desks, others. 20 complete plans \$1.00. Easy ABC assembly procedure. Plus Board Measure Nomograph Calculator. Easycraft, Box 162, Cincinnati 1, Ohio.

LEATHERCRAFT. Everything needed by beginners, advanced hobbyists and professional leatherworkers. Largest stock of supplies in U. S. Moderate-priced tooling leathers, top quality calfskins, tools, supplies, kits. Send 10c for big catalog. J. C. Larson Co., 820 S. Tripp, Dept. 3950A, Chicago 24.

PLASTICS Home-craft course for men and women. Tells and shows how to make hundreds of fast selling plastics products. All plastics and materials for 23 projects included in course. No special tools needed. Course pays for itself. Write for free booklet. Interstate Training Service, Dept. D-3-C, Portland 13, Oregon.

PETER Pan, Snow White, Seven Dwarfs, Cinderella, Red Riding Hood, etc. Full size patterns 16" to 24" high. All for \$1.00. Mastercraft 37M, 7041 Olcott, Chicago 31, Ill.

JIGSAW Owners attention! Start earning money at home cutting out wooden novelties and souvenirs. Write H. Cook, Dept. A, 4407 S. Normal Ave., Chicago 9, Illinois.

LEATHERCRAFT Supplies. Pre-cut kits, tools, etc., large stock. Catalog 10c. refunded first order. Whitman Saddle Mfg. Co., 1725 Powers St., C3, Cincinnati 23, Ohio.

LAMP And shade parts. Low cost materials, patterns, kits. Vase, oil lamp converters. Catalog 10c. Crafttime, A1, Newark, Delaware.

LEATHERCRAFT. Tremendous stock of leather, tools, supplies, and kits. In leather business over forty years. Send 10c for big catalog. Sax Bros., 1111 No. 3rd, Dept. PM3, Milwaukee 3, Wisconsin.

16 New Lawn chairs, 23 picnic tables, benches, trellises, etc. All 38 plans with necessary full size patterns, \$1.00. Mastercraft 33M, 7041 Olcott, Chicago 31, Ill.

FREE—Make-it-yourself craft catalog. low-cost kits and supplies. American Handicrafts, Box 1479-M, Fort Worth, Tex.

89 Full Size Jig Saw patterns of beautiful shelves, ornaments, toys, novelties. Plus "How, Where to Sell." Only \$1.00. Mastercraft 34M, 7041 Olcott, Chicago 31, Illinois.

GENEROUS Bundle clear soft wood, assorted sizes. Ideal for carving, hobbies, woodcraft. \$1.99 postpaid. North Woods By-Products Co., Box 3504, St. Paul, Minn.

WOODWORKERS: Ingenious center-finder determines exact center of wood stock to be turned on lathe. \$3.50 postpaid. Literature free. Barr's, Perry Highway, Pittsburgh 37, Penna.

ASSEMBLE Jewelry, gifts. Free catalog. details. Novelcrafts Co., 25C Adrian Ave., New York 63, N. Y.

UNPAINTED Maple leaf wall brackets. \$1.50 set of two. Ideal gifts. Full size plans 25c. F. & S. Specialty, P. O. Box 275, Philadelphia 5, Penna.

GRANDFATHER Clocks, weight driven movements. Willis Bros., 237 South Ellwood Ave., Baltimore 24, Maryland.

LAMP Size cypress knee \$1.00. Cy Products, Dept. 1, Lafayette, La.

GENEROUS Supply assorted leather findings. Ideal for knife holsters, key rings, novelties, etc. \$1.98 postpaid. North Woods Leather Findings Co., Box 3504, St. Paul, Minn.

BUY Wholesale nationally advertised power, hand tools, thousands other products at big discounts. Free "wholesale plan." American Buyers', 628-PP Linden, Buffalo 16, N. Y.

SPRINGS. New assorted 1/16" to 1/4" a.d. Tension, compression, torsion. 300-400, per lb. \$1.00. Box 404, Compton, Calif.

WHITTLERS? Seven wood blanks of Gulf Coast waterbirds for only \$1.00. Villa Capri Enterprises, General Delivery, Aransas Pass, Texas.

NEWEST Spare, full-time home business. \$5 to \$10 hour possible. Paint with suede—the finish with touch and eye-appeal. Beautifully auto dashboards, signs, radios, toys, figurines, lamps—1001 others. Complete, step-by-step instructions sent for no-risk examination. Free details. Coast, 1004-RN So. Los Angeles St., Los Angeles 15.

FREE! Leathercraft catalog free! Write Box 397C, (Only costs you 2c). Tandy Leather, Tulsa, Oklahoma.

FOR Do-it-yourself craftsmen. Tops in useful information about materials, tools and how-to, from work bench to home repairs and improvements. "Home Handbook" pocket size, 80 pages. 25c postpaid. Arkansas Soft Pine Bureau, 222 Boyle Building, Little Rock, Arkansas.

FURNITURE Handles. Solid brass. Free literature. Colony House, Box 1892, Huntington, West Virginia.

METAL—Rounds, flats, sheets. Small order inquiries invited. Tools, Will's Crafts Service, Box 3922, Detroit 27, Michigan.

PINE Root for beautiful driftwood lamp. \$1.00 plus postage, c.o.d. Instructions included. Gover's Sales, Sheridan, Mich.

LEATHERCRAFT. Metal tooling, textile painting, beadcraft, shellcraft, many other crafts. Fun, easy, profitable! Free, big, illustrated catalog. Write today. Kit Kraft, Dept. 253, Hollywood 46, Calif.

VIOLINMAKERS. Amateurs, professionals. Fine tone European wood. Materials, tools, supplies, patterns, instructions. Illustrated catalogue 10c. Refundable. Premier Violin Supplies, 430 South Broadway, Division PVM, Los Angeles 13, Calif.

35 LAWN And garden ornament patterns. Full size, ready cut, colors indicated. Only \$1.00. Lincoln Craft Studio, Columbia, Conn.

JIGSAW Patterns! Large variety especially for boys, \$1.00. Pauls, 2233A North 35th, Milwaukee 8, Wis.

LEATHERCRAFTERS: Illustrated catalog shows everything you need. 10c. Complete stock "Craftool" stamps. Art Leather, 411 Joseph Ave., Rochester 5, N. Y.

REFINISHERS. Small shops; we specialize in industrial type wood finishing materials, small or large units, our catalog contains brush or spray specifications for 23 different "Modern Furniture Finishes." Send 25c for catalog. Gaston Finishes, Box 446M, Bloomington, Indiana.

CRAFT Leathers, supplies, lacing, kits, tools. Send 25c for latest catalog. Jonas Handicraft Co., 30 Frankfort Street, New York 38, N. Y.

KNOCKDOWN Pine picture frames. 3-5"x7" \$1.00. D. Genovese, 9 Liberty St., Stamford, Conn.

KNOCKDOWN Cedar chests. Lumber and veneers. Free price list. Giles & Kendall Company, Huntsville, Ala.

100 FULL Size jig saw patterns up to 20" high, only \$1.00. Pattern Service, Medway 9, Mass.

\$46 FROM Square foot plywood; jigsaw necessary. Write: Woodarts, Bridgewater, Mass.

129 NEW Full size jigsaw patterns. Unusual novelties, gifts, lawn figures up to 22 inches high, action (merry-go-round) windmill, toys, useful gadgets. Artist drawn. \$1. Craftplans, 1321-A South Michigan, Chicago 5.

FREE Information. Money-making full size patterns. Professional designs. Furniture, gift shop items. Write Jigsawers, 117 Worth, New York 13.

LEATHERCRAFT—New stylecraft folder free. New kits illustrated. Pilgrage belts, billfolds, purses, etc. Send 25c new catalog. Refunded first order. Apache Leather Co., 2804 East Washington St., Phoenix, Arizona.

LEATHER, Tools, lacings, supplies. Free catalog. National Handicraft, 199 William St., New York 7.

"TOPS" In everything for leathercraft. Lowest prices. Genuine "Craftool" stamps. Catalog 10c. Crown Leather Company, 22 Spruce Street, New York 38.

KNOCKDOWN Cedar chests and lumber. Free price list. Bedford Lumber Company, Shelbyville, Tennessee.

LEATHERCRAFT. Metal tooling, textile painting, beadcraft, shellcraft. Many other crafts. Send for free, big, illustrated catalog today! Kit Kraft, Hollywood 46, Calif.

MAKE IT YOURSELF

FAMOUS Contour chair from plywood, canvas. Plans \$1. Technipress, Box 7555, University Station, Baton Rouge, La.

MAKE Your own electric fuse plugs. Model \$1.00. W. Stonebraker, 6006 Harney, St. Louis 20, Mo.

\$900.00 BUILDS Home, four rooms, bath. Car port, concrete block construction. Plans, material lists, instructions, \$1.00. U-Build-It Enterprises, Box 230, Springdale, Arkansas.

AWNINGS—All-aluminum. Make your own! Assemble America's most beautiful aluminum door canopies and window awnings. The sides are pre-assembled. Save 50%. Factory to you. Free measuring chart and literature. Herbert's Aluminum Awnings, Dept. 1, 8974 St. Charles Rd., St. Louis 14, Mo.

WATER—Softener, standard 32,000 grain. Save \$150.00. Tank, everything included. \$60.00 Minneapolis. Joribo Products, Box 1373, Minneapolis 19, Minn.

BUILD Copyrighted concrete block duplex \$1300. Living room, kitchenette, bedroom, bath, each side. Full size blueprint, instructions, cost estimate, \$1.00. Illustrated details free. Bailey Builders, 915 Pyramid Building, Little Rock, Ark.

BUILD Inexpensive concrete blockmaker. Motor-hand. Then, make blocks for 3 room house for \$93. Write: C. Lee, Mountain View, Oklahoma.

BASEMENT Window greenhouse plans. Complete for early planting. \$1.00. Jays, 2112 Portland, Minneapolis.

ELECTROPLATE. Baby shoes, hardware. Profitable business. Details free. Easyplater, Box 2938PM, Red Lion, Penna.

MELT Iron with old crankcase oil for castings. Urutz Burner Co., Box 92, Globe, Arizona.

BUILD Automatic electric clothes dryer. Complete plans \$1.00. Nunley Enterprises, 3390 Wiley, San Leandro 9, California.

BUILD \$8,500.00 Home for \$3,500.00. Details ten cents. Tom-Bilt Homes, Box 481-M3, Fitzgerald, Georgia.

BUILD-It-yourself kits for bench saw, bandsaws, belt sander. Hand tools only needed. Catalog free. Gilliom Power Tools, Lambert Field, St. Louis 21, Mo.

OIL Drum heats shop, store, etc. \$10.00 worth waste product runs heater all winter. Plans, instructions, \$3.00. Twain Associates, 448 Hannibal, Mo.

GRANDFATHER Clock easily built. Big savings. See ad on page 277.

NEWEST Spare, full-time home business. \$5 to \$10 hour possible. Paint with suede—the finish with touch and eye-appeal. Beautifully auto dashboards, signs, radios, toys, figurines, lamps—1001 others. Complete, step-by-step instructions sent for no-risk examination. Free details. Coast, 1004-RZ So. Los Angeles St., Los Angeles 15.

WOODTURNERS. Schools. Six beautiful designed turned clock projects plans. \$1.00 postpaid. Clock movements, Clocks, 115-16th So., Great Falls, Montana.

BUILD Beautiful folding coffee table—Full size plans and steel folding mechanism \$2.75. Free photograph. Vavrik Industries, Rossford, Ohio.

RUSTIC Ornamental iron. Make your own railings, hinges, pots, decorative metal pieces. Liquid metal—Brush it on wood, aluminum or metal. Will not rust. Send \$2.45. Atech Supply Co., 3840 Lagrange St., Toledo, Ohio.

MAKE Your own stone-veneer. Economical, easily made, quickly applied. Looks like genuine stone. Formulas, illustrations, patterns \$1.00. Alburg, Box 17, Carrollton, Mich.

BUILD A treasure and metal detector. Lightweight, sensitive, inexpensive. Complete kits, free literature. Dept. 1, Electronic Applications, Box 4975, Washington 8, D. C.

BUILD Your own tractor. Free information. Eltraco, D-J, Camptonville, California.

MAKE Your own power mower (gasoline or electric). Cuts lawn up to 10 ft. growth. Everything furnished in complete kit. No special tools needed. Easy to assemble. Saves dollars. Details free. Kut Up Co., 7528 Oakwood, Rt. 4, Omaha, Neb.

WATCHES, OLD GOLD, JEWELRY

WATCH And clock repairing books for hobbyists. Free information. North American, Dept. 14-C, 2329 N. Milwaukee, Chicago 47, Illinois.

HIGHEST Prices paid for old gold, silver, platinum, diamonds, watches, gold teeth, spectacles. Cash immediately. Goods returned if offer unsatisfactory. United Smelting Works, (The Old Reliable), 6-B East Monroe, Chicago 3.

WATCHMAKERS' Tools, materials, supplies, watches. Catalog. Gales, Box 1000, Chicago 90, Ill.

PIX Watches for pay or pastime. Free sample lesson. Chicago School, Dept. PM-3, 2330 Milwaukee Ave., Chicago 47, Ill.

JEWELRY For hobbyists, imported rhinestones. Free catalog. Sexton, Box 44, Station G, Buffalo 13, N. Y.

FREE Sample pair of earrings shows you how easy it is to make beautiful costume jewelry. Over 5000 styles listed in new catalog, 25c. Barry's, 178 Ardley Court, Newark, N. J.

HIGHEST Cash paid for old gold, broken jewelry, gold teeth, watches, diamonds, silverware, spectacles, platinum. Free information. Satisfaction guaranteed. Rose Smelting Company, 29-A East Madison, Chicago.

CUCKOO Clock repair. Beach's Clinic, 4055 S.E. Taylor, Portland 15, Ore.

WATCHMAKERS' — Jewelers' complete informative catalogue 25c. Bengale Company, Culver City, California.

JEWELRY Making can be a profitable hobby—Send 25c for our latest illustrated catalog. Milady-Pair Co., G.P.O. Box 1328, New York City.

TOBACCO, SMOKERS' SUPPLIES

PIPE Smokers! Cigar smokers! Free illustrated catalog offers fabulous savings on choice imported and domestic pipes, cigars, tobaccos, supplies. Write Wally Frank, Dept. 1, 150 Nassau St., New York 38, N. Y.

PIPES Repaired—Expert craftsmanship, work guaranteed. Briar pipes, vulcanite stems, \$1.75. Free estimates. Fred Diebel, Pipe-Lighter Service, 103 East 11th, Kansas City, Mo.

FOR THE HOME

FOAM Rubber furniture cushions. Factory seconds, 50% discount. Free catalog. Perma-Foam, 140-C Main Street, East Orange, New Jersey.

HEAT Homes efficiently. Prints marked. Bill of material listed. Details free. Garver Company, Vermilion, Ohio.

OF INTEREST TO WOMEN

COMPLETE Quality line artificial florist supplies. Woodfibre, leaves, centers, novelties. Catalog 10c. Profitcrafts, 4516C21 Lorain, Cleveland 2, Ohio.

EARN \$50 Weekly spare-time selling vitamins! National Health Products, 150 Broadway, Dept. W-2, New York 38.

FREE Catalog from your home shopper. Exciting new time and money saving items for successful homemaking. Write Pisher's, 1110 E. 47th Place, Los Angeles 11, Calif.

DOLLS, Dressed, or undressed. Doll hospital. Peggy's Doll House, Jefferson City, Missouri.

NYLONS 14c. Anklets 6c, socks 9c, print 17c, panties 12c, dresses 30c, slips 47c, undershirts 17c, robes \$1.65, spreads \$2.65, jewelry \$1.25, watches \$3.50, electric razors \$2.00, aspirin \$1.00—1,000, brushes 9c, razor blades 1 1/2c, pens 8c, combs 1 1/2c. Complete stock list, picture catalogue, 25c. Send immediately. Sibert's, Chattanooga 4, Tennessee.

WOMEN Who knit—New, unlimited opportunity for big profits at home. Invisibly reknit damaged sweaters, skirts, all knitted garments and fabrics for cleaners, tailors, stores, friends. Make holes, tears, cuts, thin spots disappear. Earn up to \$10 an hour. Learn in days from complete low cost course never before offered. National Reknitters, Dept. 10, 1525 E. 53rd, Chicago 15, Illinois.

WHY Pay retail prices? Send for free catalog showing nationally advertised merchandise at discounts. Marshall Sales Co., 2016 Edmondson, Baltimore 23, Maryland.

DISTINCTIVE Wood gifts. Catalog 10c. Wood Hut, Three Lakes, Wisconsin.

GROW Mushrooms. Cellar, shed, and outdoors. Spare, full time, year round. We pay \$3.50 lb. We paid Babbitt \$4,165.00 in few weeks. Free book. Washington Mushroom Ind., Dept. 176, 2954 Admiral Way, Seattle, Washington.

MAKE Big money at home! Invisible reweaving pays \$10.00 profit an hour spare time. Make tears, cuts, holes disappear from fabrics. Constant demand from laundries, cleaners, homes assures steady earnings. Details free. Fabricon, Dept. C, 8342 S. Prairie, Chicago 19, Ill.

GOOD Money in weaving. Weave rugs at home for neighbors on \$69.50 Union Loom. Thousands doing it. Booklet free. Union Looms, 153 Post St., Boonville, N. Y.

PROFITABLE Home business. Make fast-seller chenille monkey trees, dolls, flowers. Terrific holiday demand. Information free. Velva, Bohemia 16, N. Y.

FOR SALE—MISCELLANEOUS

OLD Wall telephones. Working order, oak cabinets, hand crank for ringing, \$5.00 each. Turtle Lake Telephone Co., Turtle Lake, Wisconsin.

SAVE. Join mail order group. Details free. Color-Glo Products, Monument Beach, Mass.

100 MONEY Making plans \$1.00. Empire Distributors, Box 301, Amesbury, Mass.

FREE "Value Parade Bulletin" on request. 17 jewel waterproof wristwatches only \$16.95 postpaid. Satisfaction guaranteed. House of Jon, P.O. Box 844, Chicago 90, Illinois.

WANTED—MISCELLANEOUS

OLD Mechanical penny banks. Big prices paid. Gordon Grimes, 2000 Marber, Long Beach 15, California.

GRINDER And saw filer. Box 574, Pearl River, N. Y.

SCRAP Mercury (quicksilver) containers supplied—Tantalum, bismuth, tungsten. Metallurgical Products Company, Established 1909, 35th and Moore Sts., Philadelphia 45, Penna.

QUICKSILVER. Platinum, silver, diamonds, indium. Write. Wholesale Terminal, Norwood, Massachusetts.

PERSONAL

LETTERS Remailed Dallas postmark 25c each. Sharon, 3114 Aster, Dallas, Texas.

"**HOW** Can I find out?" You can! Information confidentially developed. Any matter, person, problem. Worldwide. Officially licensed. Established 1922. William Herman, 170 Broadway, New York City.

LETTERS Remailed from Cape Cod, 25c each. B. Adams, Box 333, Harwich Port, Mass.

LETTERS Remailed 25c. Personal receiving-forwarding address available. Write for rates. McLaughlin, 800 Stewart, Columbus 6, Ohio.

WONDERFUL Copenhagen. Letters remailed. Air \$1. Sea 4 for \$1. Beautiful viewcards 6 for \$1. Bendesen, Hesselegade 48, Copenhagen, Denmark.

BORROWING By mail. Loans \$50 to \$600 to employed men and women. Busy, quick. Completely confidential. No endorsers. Repay in convenient monthly payments. Details free in plain envelope. Give occupation. State Finance Co., 323 Securities Bldg., Dept. N-14, Omaha 2, Nebraska.

LAND Of enchantment remains 25c. Classified \$1.00. Petes, 3202 4th N.W., Albuquerque, New Mexico.

LETTERS Remailed 25c. Personal forwarding address. Monthly rates. Shanks, Box 3110, San Francisco 19, California.

NATIONWIDE Confidential remail, name postmark 25c. Wholesale remail directory information 25c. Stonaker, Box 3503C, Jacksonville 6, Fla.

NEW York, Los Angeles, Tijuana remailing 25c. F. Holmes, 152-P E. 27 St., New York 16, N. Y.

LETTERS Remailed 25c. Private receiving-forwarding address available. Hicks Service, Box 1547, Washington 13, D. C.

WASHINGTON, D.C., remails 15c. Send 10c for complete list many interesting services, souvenirs. Reasonable prices. Efficient, prompt service. National Capital Services, Box 76, Washington 4, D. C.

BILLFOLD Secretaries — Name and address on twenty perforated sheets and beautiful two color cover. 10 secretaries \$1 postpaid. Sample 10c refunded. Peters Associates, Troy, Ohio.

NEW York City, Philadelphia remail 25c. Classifieds 50c, foreign newspapers \$1.00. Fahrman, 335 N. Penn., Allentown, Penna.

REMAILS 25c. Classifieds \$1, six scenic cards \$1, private address. Confidential services. Relayco, Box 333, Augusta, Ga.

EMBARRASSED Because you make mistakes in English? Free 32-page booklet tells how to avoid mistakes, speak and write effectively. New method takes only 15 minutes daily. Write Career Institute, Dept. C-1, 25 E. Jackson, Chicago.

LETTERS Remailed 25c. Receiving-forwarding service. Hughes, 3900 21st St., N. E., Washington 18, D. C.

NEW York City—Letters remailed 25c each. Bonomo, 54 Jefferson St., Brooklyn 6, New York.

ATLANTIC City remailing, 10 beautiful postals \$1.00. Letters 25c. 14 S. Georgia, Atlantic City, N. J.

LETTERS Remailed 25c each. Private Pronto Service, P. O. Box 118, Miami Beach, Fla.

SOUTH America letters remailed airmail \$1. Roberts, Apartado 4376, Oficina Este, Caracas, Venezuela.

IMPRESS Your friends. Ten beautiful postcards of Notre Dame University. You address and return. We remail here. Send one dollar to Remail, 1631 Lincoln Way East, South Bend, Ind.

LETTERS Remailed 25c each. 5 scenic cards \$1, remailed free. Homer, 13247 Sayre, San Fernando, California.

MISCELLANEOUS

CARVED Nameplates. Your name deeply carved in California Redwood for cabin, trailer, apartment, mail box or porch. Attractive script lettering. Scroll or plain ends. \$1.00 postpaid. Nameplates, Box 1868, Richmond 1, California.

WHOLESALE. Electrical appliances, Philco, Admiral, Speedqueen, washers, air-conditioners, refrigerators, radio, freezers, electric ranges, television. P.O.B. Tampa, Fla. Send for brochure and price list. Midway Television & Appliance, Mail Order Division, Dept. PM3, 2216 4th St. No., St. Petersburg, Florida.

HOME Study for game warden, fish, park, forestry, wildlife and patrol service. Details free. Write Delmar Institute, A5, Whittier, Calif.

GOLD, Silver, metal detectors. Geiger counters for uranium. Mineralights. Sensational new fully guaranteed models. None finer. Information free. Detecron Corp., 5420 Vineland Ave., North Hollywood, California.

LEATHERCRAFT For pleasure or profit. Make easy-to-assemble purses, belts, gloves, woolskin toys, 100 other items for gifts or to sell. Send 10c today for big catalog. Largest leathercraft stock in U.S. J. C. Larson Co., 830 S. Tripp, Dept. 3751, Chicago 24.

FREE \$3.00 Necklace: 13 pair nylons (rejects) \$2.98. Economy, 28 Trinity, Lynn, Mass.

FREE Catalog of clothing for big men. Waist 46-66, neck 17-22. Burns Martin, Dept. 495, 121 Summer St., Boston 10, Mass.

MARBELCRETE—Stops all dusting and wearing away of cement floors. Permanent treatment. Information free. Becker Paint & Varnish Co., Bay City, Michigan.

300 PROJECTS You can make—In Popular Mechanics 32-page Blueprint catalog. Send 3c stamp for copy. Popular Mechanics Press, Dept. 166, 300 East Ontario St., Chicago 11, Ill.

GORGEOUS Personalized handkerchiefs. Mens, ladies, \$1.00. Initials, names, designs. Button's, 111 E. Santa Clara, San Jose 13, California.

LOCATE Hidden treasure, distinguish minerals from metals with the Model 109 Detector. Weighs 5 pounds, extremely sensitive. Factory assembled \$79.90 or kit form \$39.90. Free literature. Dept. P, Electronic Applications, Box 4975, Washington 8, D. C.

BUY Nationally advertised merchandise at tremendous discounts. A postcard brings free catalog. Fleming's Quality Merchandise, Box 5223M, St. Louis 10, Mo.

FREE List for post card. Soaps, blades, lotions, and other masculine necessities at large savings. Sullivan, Box 5655, Chicago 80, Ill.

FINE Hand carved western leather belts. Any name, any length, \$6.95. Lillard's Leathercraft, Friona, Texas.

FREE! Color coded television adjuster. Powers, 104 West Fifth, Covington, Ky.

MAGNETS—Permanent airtight. Never loses magnetism. Many uses. Excellent for map, bulletin work. No. 3, 12 for \$1; No. 5 stronger (magnetic pot holder magnets) 6 for \$1. Quantity prices. Pritt Co., Dept. MM-3, 12 West 27th, New York City.

AMMONINE Nonflammable spot remover. Money-maker. Sample 25c. Yale-Murphy, Meriden, Conn.

NEWEST Spare, full-time home business. \$5 to \$10 hour possible. Paint with suede—the finish with touch and eye-appeal. Beautifully auto dashboards, signs, radios, toys, figurines, lamps—1001 others. Complete, step-by-step instructions sent for no-risk examination. Free details. Coast, 1004-SC So. Los Angeles St., Los Angeles 15.

\$10,000 IN Building materials for \$100. Secret for \$1. Hegel Associates, P.O. Box 68, Berkeley, Calif.

PENMANSHIP Courses. Improve your writing quickly. Learn shaded writing. Greeting cards—Name cards, elegantly written. Free literature. Tevis, A-23, Chillicothe, Mo.

GERMAN Address lists. Anything manufactured. \$1.00. Burke Associates, Manchester 1, Mass.

BUY Wholesale thousands nationally advertised products at big discount. Free "wholesale plan." American Buyers, 631-D Linden, Buffalo, N. Y.

FAT Men! Big men! Tall men! We fit the hard-to-fit. Free clothing catalog. Cushner's, 2122 W. Pratt, Dept. 112, Baltimore, Maryland.

WAKE Up your mind. Be what you desire. Free "know how" lecture and exciting home-study details may be had by writing Applied Christian Psychology, Inc., Box 1924-M, Louisville 1, Ky.

PANNING Gold—Free lesson; catalogue of mining, mineral books, supplies. Old Prospector, Box 729D1, Lodi, Calif.

FREE 1954 Catalog on government surplus bargains from country's largest surplus organization specializing in outdoor, sporting goods, clothing, camping equipment. Tents, rubber boats, tarpaulins, swim fins, hundreds of other items. Rock-away Sales Co., Dept. PM, Route 48, Rock-away, New Jersey.

"MIRACLE Mind." Acquire mind of genius. Details 10c. Krishnar Institute, 1912 Lincoln-Park-West, Dept. MP-2, Chicago 14.

RECEIVE Magazines, samples, catalogues. Mails from everywhere. Offers, hundreds. Get listed 25c. Rorick, Box 86, Cincinnati 26, Ohio.

URANIUM Big samples. Radioactivity guaranteed. One dollar. No stamps. WRS, Alameda, New Mexico.

GROW Mushrooms. Cellar, shed, and outdoors. Spare, full time, year round. We pay \$3.50 lb. We paid Babbitt \$4,163.00 in few weeks. Free book. Washington Mushroom Ind., Dept. 175, 2954 Admiral Way, Seattle, Washington.

SEPTIC Tank, outdoor toilet cleaner. Forget disposal worries. One Peptank treatment flushed into toilet monthly unclogs pipes, reduces mass and odor. Harmless to plumbing and fields. Trial supply, \$1.25. Year's supply, \$3.50. Postpaid. American Chemical Supply Company, Dept. J, 532 North 18th Street, Richmond 23, Virginia.

INCREDIBLE! Become mental superman overnight! Free booklet! Bijou, Box 1727-ME, Hollywood 28, California.

OUTDOOR Toilets, cesspools, septic tanks cleaned, deodorized with amazing, safe, harmless powder. Easy, economical to use. Saves digging, pumping. 150,000 customers guarantee satisfaction. Details free. Burson Laboratories, Dept. O-36, Chicago 22, Illinois.

300 BIG Malls guaranteed. Samples, plans, offers, propositions, 12 months listing, \$1.00 refundable. Wright Publications, 2270 Hubbard, Memphis 8, Tenn.

CIGARETTES—Roll 200 mild, tasty, guaranteed to please for 75c. Details free. Pete Moberly, Box 857, Owensboro, Ky.

SELECTIVE Metal and mineral detector. Revolutionary design. Distinguishes metals from black magnetic sands. Readily detects metals under salt water. Also Geiger counters. Free literature. Gardiner Electronics Company, 2018 N. Dayton, Phoenix, Arizona.

TREASURE Finders for gold, silver and minerals. Money back guarantee, best available. Also Geiger counters for uranium prospectors. Free information. Write Goldak Company, 1541 West Glenoaks, Glendale 1, Calif.

BE The Popular Mechanics representative in your neighborhood and earn big profits in your spare time. Write Popular Mechanics Magazine, Room 408M, 200 E. Ontario St., Chicago, Ill.

TREASURE—M-Scope Geiger counters, mineral locators. Why buy something inferior when you can buy the best at a lower price? Backed by years of experience. Fully guaranteed by factory. Detects minerals, metals, gold, silver, coins. Payment plan available. Proven superior performance. Free 16 page illustrated booklet. Fisher Research Lab., Inc., Palo Alto, California.

CLOGGED Drains opened by new powerful chemical called Sursolvent. Removes grease, soap, tree roots, etc., without expensive digging and electric rodding machines. Simple to use. Mix with water and pour down sink. Postal brings free details. Electric Sewer Cleaning Co., Allston 34, Mass.

TREASURE Of invaluable information for anyone planning a vacation trip is John P. Arnold's Motor Tourists Guide. Complete with 12 pages of maps, the Guide tells how to pick the right place to go, the most effective way to travel, how to budget the trip, choose the right clothes to take along, motor courts and how to choose the one to stay in, what to do in case of accident, and what equipment to take along. The book, \$1.00, shows highways, scenic roads, recreational and sport areas. Popular Mechanics Press, Dept. M.T., 200 E. Ontario, Chicago 11, Ill. Send in your order today!



FREE 11 HITLER STAMPS

Eleven colorful Hitler stamps—all different, all sought-after—sent FREE to secure names for our mailing list. We'll also include other interesting offers for your inspection—PLUS a FREE copy of our helpful, fascinating "How to Collect Stamps." Supply limited, so rush name, address, and 10c to help cover postage and handling costs. Address: Littleton Stamp Co., Dept. PM-3, Littleton, N.H.

SEE HOW EASY IT IS
Step by Step!

BE AN ARTIST

Enjoy a profitable career or a satisfying hobby. Start commercial art, cartooning, painting, illustrating. Free booklet shows how you can earn while you learn; describes enormous demand for artwork; artists' earnings; home study advantages; outlines course. This is our 40th year—we have helped thousands to draw for pleasure and profit. Course includes 2 art outfits. Life Class Book, book "How to sell your work." Mail coupon today. Career or Hobby Course. No salesman will call.

WASHINGTON SCHOOL OF ART, Studio 123N
Washington 5, D. C.

Send free booklet Career Hobby

Name _____ Age _____

Address _____

City, Zone, State _____

REAL ESTATE BE A BROKER

PAYS BIG! SEND FOR FREE, BIG, ILLUSTRATED CATALOG NOW! Graduates report making substantial incomes. Start and run your own business quickly. Men, women of all ages, learn easily. Course covers Sales, Property Management, Appraising, Loans, Mortgages, and related subjects. **STUDY AT HOME** or in classrooms in leading cities. Diploma awarded. Write TODAY for free book! No obligation. Approved for World War II and Korean Veterans.

WEAVER SCHOOL OF REAL ESTATE (Est. 1936)
Suite 300 Law Bldg. Dept. PMS Kansas City, Mo.

BUY IT GET UP TO 40% OFF

WHOLESALE! FREE

Start a Buying Service at Home, Spare Time. Get Big Name Wholesaler UP TO 40% OFF. (See Wholesaler's Ad.) Big Price, Sales Easy as You Can Give MEGA DISCOUNTS. STILL MAKE FAT COMMISSIONS. Post Card Brings Free Copy.

AMERICAN BUYERS SERVICE

631-R Linden Ave., Buffalo 16, N. Y.

SAY YOU SAW IT IN POPULAR MECHANICS

Super Powerful All Channel TV RECEPTION IN ALL DIRECTIONS

Rocket DIRECTRONIC MOTORLESS TV ANTENNA

- 360° Electronically Switched Beam
- No Motors
- No Roof
- Orientation
- No Electric Power
- No Ghosts
- Flick of Switch Clears Picture Instantly

In the city or in an ultra-fringe area, the Directronic will outperform ordinary antennas. Only the Motorless 360° Directronic TV Antenna offers "around the compass" reception WITHOUT Rotors. Clarity of picture will amaze, it's so bright, so sharply defined. AX-500 "Self-Steering" Array contains Hi-Pac molded insulator of extremely high tensile strength, 15 hi-tensile aluminum alloy elements, 1 set of connecting studs (3), Universal U-Clamps for masts to 1 1/2", Directronic Beam Selector, 75 feet of Tri-X Cable. Do not permit more than complete purchase price. 25% deposit on C.O.D. orders, please. Money-back guarantee.

NATIONAL ELECTRONICS OF CLEVELAND
303 DELCO BLDG. CLEVELAND 3, OHIO

New FALSE PLATE

for OLD
IN 24 HOURS

Low As Only
\$15.95



Wonderful New Scientific Method Transforms OLD, LOOSE, Cracked or Chipped Plates into LUSTROUS BEAUTY-PINK DUPONT PLASTIC PLATES

MONEY BACK GUARANTEE

Why envy beautiful false teeth of others? We will transform your old, loose, cracked or chipped plate into a beautiful new, lightweight DuPont Beauty-Pink Plastic Plate, using your own teeth. All missing and broken teeth matched and replaced. Your cost amazingly low; actually save many dollars. No impression needed under our new scientific False Plate Method. 24-Hour Service.

SEND NO MONEY Enjoy life again, and save money on beautiful, new, natural-looking plastic plates. Rush name, address for full details sent FREE. If your plate is loose, we show you how to make it comfortable, tight-fitting before duplication. West Dental Laboratory, 127 N. Dearborn St., Dept. E-128 Chicago 2, Ill.

Watch Repairing Pays Big Money Learn at home



Watch repairers in great demand. Train step-by-step in 10 easy lessons. We furnish all tools and 15 jewel watch and practice movement. Turn spare time into cash. A licensed school. Low cost. Send for FREE book today.

ILLINOIS SCHOOL OF WATCH REPAIRING
2870 Elston Ave., Dept. P.M. 34, Chicago 18, Ill.

GERMAN export - import - manufacturers

address lists on gummed labels. Mixed list \$1. Over 17,000 classifications. Complete 800 page directory \$7.95 postpaid anywhere. English Index. Special lists any country \$2. Details free. International Directory Service, Box 248, Manchester, Mass.



HE-MAN VOICE!

STRENGTHEN your voice this tested scientific way. Yes—you may now be able to improve the POWER of your speaking and singing voice . . . in the privacy of your own room! Self-training lessons, mostly silent. No music required.

FREE BOOK Write TODAY for Eugene Feuchtinger's great booklet "How to Develop a Successful Voice." It's absolutely FREE! You must state your age. Booklet mailed postpaid in plain wrapper. No salesman will call. Send your name and age RIGHT NOW! Perfect Voice Institute, 210 S. Clinton St., Studio CW-2, Chicago 6, Ill.



HAVE A BIGGER - MORE EFFICIENT HOME WORKSHOP

Popular Mechanics' PLANNING YOUR HOME WORKSHOP shows you how to make use of every inch of space in your workshop; detailed floor plans, wiring layouts and power tool hookups plus actual photographs of famous home workshops you can use as models. Save money by building your own shop furniture. Special Where-to-Buy-It Guide. 450 Illustrations. Cloth Bound. Working Diagrams. Order your copy today from

\$2.50
POPULAR MECHANICS PRESS
200 E. Ontario Street Chicago 11

IT'S A "HIT!"

Order your revolutionary new "HIT" miniature camera today! Greatest value ever offered in a fine imported camera. Low price includes genuine pigskin carrying case, also roll of film. Smaller than a matchbox! Precision made, easy to use. Additional films 30c per roll of six rolls for \$1.50. Enlarge to beautiful 2"x2" prints. Ten exposures per roll. Wonderful gift for young and old.

LOW PRICE OF \$4.95

Shipped C.O.D. plus postage charges. Write today to Hit Sales, P. M. Box No. 524, Maywood, Illinois.

STOP BURNING OIL!



LOSING POWER
WASTING \$\$\$

When your car "eats-up" oil, loses that get-up-and-go power, has poor gas mileage, it's a sure sign that you have worn rings, pistons, and cylinder walls in your engine. This is robbing you of driving pleasure and valuable \$\$\$ to the tune of \$250 every 10,000 miles in oil, gas, and repair bills.

WHAT CAN YOU DO ABOUT IT?

You can either have an expensive overhaul job done or offset this wear with a

RING-RE-NU MOTOR RECONDITIONER KIT

It's the inexpensive, proven answer to a worn engine. This terrific 1-2 combination restores power and zip to your car without expensive repair work, reduces oil burning, slashes gas consumption, brings back that "new car" performance to your car.

HERE'S HOW THIS DOUBLE VALUE KIT PERFORMS!

- 1. PVR COMPOUND**—is a hard hitting engine reconditioner that removes sludge, tars, sticky greases from a tired, worn engine. Pour in carburetor, idle engine. Leaves rings, valves, pistons whistle clean, ready for . . .
- 2. RING-RE-NU**—the amazing compound which when squeezed by tube on your pistons forms a tough, pliable, self-expanding seal on rings and pistons to compensate for wear.

RESULT!—You get power-packed, economical driving pleasure. Good for 10,000 plus miles. Adds years to the life of your car. Guaranteed not to harm the finest engine. Takes only 30 minutes to install.

Read ACTUAL PROOF From One of 100,000 Satisfied Users!

Cadillac Owner, E. L. G., Lawrence, Mass. writes — "My Cadillac was burning 2 qts. of oil every 100 miles. I have now travelled 400 miles since installing the kit. Haven't used one drop of oil. Further my gas consumption has been cut in half. I'm more than pleased with results — best investment I ever made."

NOTE! DON'T BUY HALF A TREATMENT!

Ring-Re-Nu is more than just a seal—it's a complete 1-2 combination, PVR to clean your engine, RING-RE-NU to seal in that "new car" power.

1 tube kit \$4.95 post. treats all cars except large 8 cyl. autos which require special 2 tube kit at \$11.95 post. sold with money back guarantee. (C.O.D.'s accepted. \$1 deposit required, bal. and postage on arrival.) For economical, power-packed, new car performance — rush order to:



Only **\$4.95**

free folder available on request

RICHIE DISTRIBUTING, INC.

11916 MADISON AVENUE • DEPT. M3 • CLEVELAND 7, OHIO

RING-RE-NU . . . GOOD FOR YOUR CAR - GOOD FOR YOUR POCKETBOOK

Prints Postal Cards!

FREE Use on 30 Day Trial!

Send name today for facts and FREE Illustrated Book of unique advertising plans and money-making ideas for your business. Learn how others are boosting sales with post card ads . . . easy with Cardmaster.

Cardmaster Co., 1920 Sunnyside, Dept. 1343, Chicago 40, Ill.



SAVE \$65 ON THIS LUXURIOUS \$100 CONTOUR CHAIR 34.95 FOR



Everything Needed Complete To Put It Together In One Evening

Genuine FOAM RUBBER

Scientifically correct design for restful, healthful, relaxing. Adjusts for perfect sitting or reclining comfort. Proved beneficial to heart, nerves . . . most popular chair in the home. Prestofoam rubber and washable, pliable genuine

Duran upholstery. Would cost \$100 or more in any store. Shipped all ready to put together in less than one evening by anyone who can use a screwdriver. No cutting, no drilling, no skill needed. A woman can do it. Order now! Everything needed for only \$34.95, f.o.b. Baltimore. State color wanted: forest green, asphodel, blue, luscious red, walnut brown. Enclose \$5 deposit, balance C.O.D. Money back guarantee. Return in 10 days if not satisfied. Order now.

Bestcraft, Dept. 62, Mathieson Bldg., Baltimore 2, Md.
Make Money sitting and Assembling Contour Chairs for friends

Solingen Steel HUNTING KNIFE



\$3.95

MAKE THIS TEST!



Place a coin the size of a half dollar on some pieces of thick cardboard. Plunge the point of the Black Forest Knife downward. The knife will completely pierce the thick coin — without ANY damage to the blade!

DIRECT FROM GERMANY

The Black Forest Hunting Knife, made in Solingen, West Germany of superfine *Nackt Rosted* (non-rusting) steel is NOW available in this country! The rugged beauty of this superb knife has already won recognition for design in industrial circles on the Continent—and its utility and value as an aid in hunting & fishing has made it a prime favorite with sportsmen all over Europe! Blade is actually sharp enough to shave with; the genuine leather scabbard is metal-tipped; this knife will stand up against the most rugged treatment! 10 inches in length. Sleek, graceful lines of this new German import make it an ideal collector's item—a hunter's delight—and a dandy room or men's den decoration. Import supply is limited and selection is fast! Send 3.95 in cash, check or m.o. for prompt delivery, C.O.D.s plus fees. Your money back quickly if you're not delighted!

low 3.95 price (postpaid) means you'll have to act fast! Send 3.95 in cash, check or m.o. for prompt delivery, C.O.D.s plus fees. Your money back quickly if you're not delighted!

THORESEN'S, Dept. 6-C-80, 352 Fourth Ave., New York 10, N. Y.
Same price in Canada. Address:
Thoresen's, Dept. 6-C-80, 45 St. James St., West, Montreal 1, P.Q.

THORESEN'S, Dept. 6-C-80
352 Fourth Avenue, New York 10, N. Y.
RUSH Solingen Steel Knife on 5 Day Trial Money Back Guarantee.
 \$3.95 enclosed—Send prepaid. Send C.O.D. plus postage.
Name _____
Address _____
Town _____ Zone _____ State _____
(Canadian orders shipped direct from Canada, duty paid. No extra! Visit us in Montreal or New York.)

Say You Saw It in POPULAR MECHANICS

Paint STRIPES with New "PAINT PEN"!

Makes Straight, Curved or Parallel Lines!

Just fill glass vial with any color paint. Use like a fountain pen to stripe furniture, bikes, autos, model planes, toys, linoleum, wall board. Beautiful, clean, crisp results every time, like professional painters. No experience needed to draw straight, curved, circular or evenly spaced parallel lines. Can't clog or smear. May also be used with glue, tempera, textile paint, or ceramic underglazes. Paints on wood, glass, plastics, metal, fabrics and paper. Lasts a lifetime. Only \$1 postpaid, complete with tip for 1/16 inch stripe. C.O.D.'s plus postage. Money Back Guarantee. Order your Paint Stripping Tool today!

New! "DOUBLE-STRIPE" MODEL Only \$2.95

Newest paint stripping invention. Makes DOUBLE stripes—one wide and one narrow or two wide or two narrow at the same time. Or adapt quickly for wide or narrow single stripe. Makes 5 combinations. FREE—Send postcard for complete information... or order now... \$2.95.



\$1.00

DEALERS

Paint Stripping Tool packed in Display Cartons of 1 dozen. Fast, profitable seller. Write for discounts.

Attention All Home Craftsmen!

New Paint Stripping Tool gives "professional" results every time, yet simple and easy to use as a fountain pen. Adjustable guide keeps lines straight as an arrow. Just as easy to make curves or freehand designs. Adds new beauty, finished look to everything you paint. Send \$1 now.

WENDELL MFG. CO., Dept. 3-C
4234 Lincoln Ave., Chicago 18, Illinois

6 Other Complete Tools
Complete tools for 1/64, 1/32, 3/64, 5/64, 3/32 or 1/8 inch stripes, \$1.50 each. Extra tips 75c ea. COMPLETE KIT with ALL 7 TIPS, \$5.00. (Also 1/4" tip, only \$1.00). All tips interchangeable.

U.S. GOV'T CLOSEOUT

THIS WIRE HAS NOT BEEN OVERSEAS. This high quality two-conductor wire offered in No. 18 and No. 22 gauge is ideal for inter-rooms, lead-ins, telephones, indoor and outdoor speaker extensions, doorbells, signal and burglar alarm systems, shot firing, etc. SAMPLES ON REQUEST.



Wire

U. S. Signal Corps
Communication Wire
TWISTED TWO CONDUCTOR No. 18 STRANDED per 1000 ft. \$7.50
TWISTED TWO CONDUCTOR No. 22 STRANDED

Won't Last Very Long at These Prices

Stock Up Now — Subject to Prior Sale — Order Today
W-110-B — TWO CONDUCTOR #18 STRANDED (four steel and three copper strands) rubber covered plus weatherproof cotton braid and twisted, 5,280 feet per steel reel. Only \$3.80 per thousand feet on 5,280 foot reels or \$18.25 per reel.
W-130 — TWO CONDUCTOR #22 STRANDED and twisted (one copper and six steel strands) in your choice of rubber or plastic insulation, 10,000 feet per steel reel. Only \$3.50 per thousand feet on 10,000 foot steel reel or \$35.00 per reel.
(Note: Steel strands are incorporated for extra tensile strength and are tinned and treated for efficient conductivity.)
Wt. per 100 ft. #18 wire, 23 lbs. Wt. per 1000 ft. #22 wire, 11 lbs. All these way below market prices. Our stock will not last long! Take advantage of this exceptional closeout and STOCK UP NOW!
Prices P.O.B. Chicago. Include approx. postage on orders paid for in advance. C.O.D. orders enclose 25% balance sent C.O.D.

U. A. S. Corp. Dept. PM3, 5637 W. 63rd Pl. Chicago 38, Illinois

LOCKSMITHING & Key Making



PRACTICAL UP-TO-DATE COURSE—ONLY \$4.95

Easy-to-learn modern information for self-instruction. How to work on locks, de-code, make master-keys, repair, install, service, etc. For every handyman, home owner, carpenter, mechanic, service station operator, fix-it shop, hardware dealer, gunsmith, 53 plain illustrated lessons. FULL PRICE ONLY \$4.95. SEND NO MONEY. Just pay postman plus C.O.D. postage. Or send \$4.95 with order, we'll ship postpaid. Satisfaction guaranteed or refund. NELSON-HALL CO., 210 S. Clinton Ct., Dept. CW-2, Chicago 8, Ill.

200 ONE-EVENING PROJECTS

Start and Finish Any One of These Projects in One Evening!

The editors of Popular Mechanics have assembled 200 projects, any one of which you can start and complete in a single evening. In a few hours' time, using only simple hand tools, you can build a coffee table, magazine rack, and table or scores of other useful projects. There are projects for the entire family. Best of all, any one may be built in just a few hours. No special skills are needed. Even if you have never built anything before, you can build the 200 projects in this big new book!

Step-by-Step Instructions, Show-How Photos, Drawings

First you read how to do it in famous Popular Mechanics step-by-step instructions and then actual photos, drawings and diagrams show you how it is done.

Each Project Costs Just 1c

Just imagine! Each project costs you only 1c. Where else today can you get so much for so little? Fill out and mail the coupon now. Full money-back guarantee, of course.



POPULAR MECHANICS PRESS, Dept. EP-1
200 E. Ontario St., Chicago 11, Ill.

Gentlemen:
Remittance for \$2.00 enclosed. Rush postpaid my copy of 200 ONE-EVENING PROJECTS. Unless it is entirely satisfactory I may return it in seven days for a full refund.

NAME _____
ADDRESS _____
CITY _____ ZONE _____ STATE _____
 Send C.O.D. (U.S.A. only). Postage extra.

WHAT UNEXPECTED TREASURES WILL YOU FIND IN THIS BIG BAG OF 1,000 UNSORTED STAMPS?



**FROM MORE THAN 30 COUNTRIES—
NOBODY KNOWS WHAT'S INSIDE!**

GIGANTIC BARGAIN OFFER! To introduce the services of the world's largest stamp firm, we'll send you this big cloth bag jam-packed with more than 1,000 genuine foreign postage stamps. They're from more than 30 countries, in Asia, Europe, Africa, Australia... and they're weighed out in bulk, unpicked, unsorted, mostly still on paper, just as received from foreign missions, banks, etc. Nobody knows what's inside—you will be the first to find out! Anything may turn up. Who knows?—you may find some exceptionally rare and valuable varieties! In any case you're sure to get

a wonderful lot of stamps with which to begin, or to build up, your stamp collection.

FREE! Just send us \$1.00 for this Big Bag of 1,000 Stamps and we'll include FREE a fine Stamp Magnifier (for discovering hidden details which make some stamps very valuable) PLUS our illustrated booklet "How to Collect Stamps". If this isn't the greatest stamp offer you've ever seen, return the stamps and we'll refund your \$1.00. But keep the Magnifier and the Booklet for your trouble. Supply is limited, so send only \$1.00, with your name and address...TODAY!

The World's Largest Stamp Firm

H. E. HARRIS & CO. 375 Transit Bldg.
BOSTON 17, MASS.

LEARN INDUSTRIAL ELECTRICITY AT HOME

Practical training program includes (1) Full simplified course on Industrial Electricity—this is the same text used by a large Midwest University. (2) Experiment laboratory type assignments so that you actually have the opportunity to work on Electrical Equipment right at home. (3) Experiment Kit of meters and other equipment which is yours to keep. Get facts now about this modern practical training program in Industrial Electricity. No previous knowledge necessary. Write for Free Information today.

HAMMOND TRAINING SERVICE, PM-3, Box 787, Hammond, Indiana

RUPTURED?

Something different. Light. Cool. No leg straps. No elastic. No pressure on hips or spine. Inexpensive. Worn by Mechanics, Farmers, Doctors, etc., everywhere. Guaranteed. Write

HAND-LOCK PRODUCTS EST. 1893
DEPT. PW, PRESTON, ONT., CAN.

SPORT AND PROFESSIONAL DIVING EQUIPMENT



"IF IT'S FOR DIVING
DESCO MAKES IT!"

WORLD'S LARGEST MANUFACTURER
OF DIVING EQUIPMENT. LITERATURE ON REQUEST.

DIVING EQUIPMENT & SUPPLY CO. Dept. P. 234 N. Broadway
Milwaukee 2, Wis.

High School at Home

Many Finish in 2 Years

No classes. No time wasted going to and from school. Progress as fast as your time and abilities permit. Standard H. S. texts supplied. Thousands enroll each year in this 57-year-old school. Send for FREE descriptive booklet.

AMERICAN SCHOOL, Dept. H345
Drexel at 58th St., Chicago 37, Ill.

Without obligation, please send FREE descriptive booklet.

Name _____

Address _____



GLIDE TO THE HAUNTS OF THE BIG ONES

• Smoothly and quietly you reach the best spots when your canoe is an easily handled Old Town. Strong yet light, Old Towns are built to give years and years of pleasurable, reliable service. Every canoe is backed by half a century of skilled experience in building water-wise craft.

FREE CATALOG shows all kinds of canoes for paddling, for sailing, for outboards. Also sailboats, outboard boats, dinghies, rowboats.

OLD TOWN CANOES

Old Town Canoe Co., 143 Middle St., Old Town, Maine

PLEASE SEND ME FREE CATALOG

Name _____

Address _____

City _____ State _____

Say You Saw It in POPULAR MECHANICS

WAR SURPLUS BARGAINS

**\$500,000.00 INVENTORY
for QUICK LIQUIDATION**
Surplus items—hundreds of them for home, shop, factory, farm and outdoor use. New items, used items, reconditioned items—all at tremendous savings—all priced for quick sale.

Page After Page of Values
This big catalog shows page after page of amazing money saving values. Write for your copy today. Send 10c to cover postage, handling, etc. Write today! SEND TODAY FOR YOUR COPY

Government Surplus
— Heavy Duty
Adjustable All Purpose

our sale price. Net wt. 40 lbs. Ship. wt. 75 lbs.
Express or freight collect, only \$14.95
Send cash, save C.O.D. charges. Or send \$5.00 with order, balance C.O.D.

TRIPOD

Amazing surplus bargain! Portable, sturdy, metal tripod. Makes possible high concentration of light over large working area. From small, compact unit only 55" high can be extended to height of 12 ft. Hard rubber casters 4" in diam. with ball bearing swivel—when extended 20" from center. Ideal for floodlights, camera tripod, display rack. Excellent for photographers, illuminating night loading of trucks, outdoor swimming pools, boat landings, basketball and tennis courts, etc. Costs government many times

10c

STARK'S 509 So. State St.
Dept. PM-354
CHICAGO 5, ILL.

To Make An
**UPSET
STOMACH**
SETTLE DOWN

Take
Alka-Seltzer
BRAND Reg. U. S. Pat. Off.

and enjoy that
**FEEL
BETTER
FEELING**



ON
DISPLAY AT
ALL DRUG STORES

Acts with *instant alkalinizing action* to settle an acid upset stomach and ease that stuffy, too-full feeling. Fast, but gentle too.

ALSO TAKE
ALKA-SELTZER
FOR
HEADACHE
COLD MISERIES
MUSCULAR ACHES

AUTO SEAT COVERS



Front and Rear
\$16.85 Postpaid
Rear Center Drop
Arm Models
\$2.00 extra

**DIRECT FROM MANUFACTURER
SAVE DOLLARS**
CUSTOM MADE FOR YOUR CAR
Guaranteed Perfect Fit

Saran Plastic at the price you would normally pay for ordinary fiber covers.
BEAUTIFUL PLAIDS Blue • Green • Maroon.
Simulated Leather Caps.
IMPORTANT! Specify Car Make, Model Name or No., Year, 2 door, 4 door, Coupe, etc. Also color you want. Order yours now when you can get them at this amazing low cost. Send check or M. O. and save C.O.D. charges.

ARTRICH 54-01 QUEENS BOULEVARD • WOODSIDE 77, NEW YORK

**Build a Better Garage
for One Half the Cost!**

Get New Popular
Mechanics Book Be-
fore You Build, Buy
or Plan Any Garage

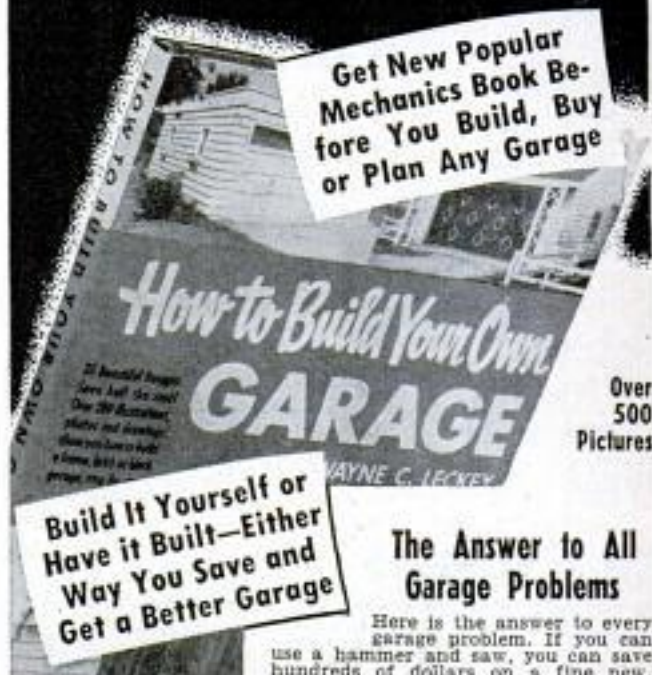

Over
500
Pictures

Build It Yourself or
Have it Built—Either
Way You Save and
Get a Better Garage

**The Answer to All
Garage Problems**

Here is the answer to every garage problem. If you can use a hammer and saw, you can save hundreds of dollars on a fine new, modern garage. Get "How to Build Your Own Garage," Popular Mechanics' simplified How-to-Do-it book for the amateur builder and follow the pictures and instructions. If you prefer to have your garage built by others, get this book first for it can solve any garage problem you may have.

**Car Ports, Garages—
Brick, Block, Frame
—They're All Here!**

Also valuable information on attractive garage doors; how to dress up a garage; space for storage, workshop, recreation, automatic door operators, planning and making your own driveway—plus pictures and instruction for every construction detail if you want to build your garage yourself.

Prepared especially for the inexperienced builder by Wayne C. Leckey, associate crafts editor of Popular Mechanics, with the assistance of many builders, manufacturers and associations in the building, lumber and hardware fields. It TELLS HOW in simplified, step-by-step instructions—SHOWS HOW with hundreds of plans, diagrams and actual photographs.

Money Back Guarantee

Mail the coupon for "How to Build Your Own Garage" today. Use the book for 7 days and return it for full refund if it does not please you. You can't lose under the P. M. guarantee of satisfaction or your money back.

**25 Designs
to Choose From**

Every type—every style—every size. All shown in actual photographs to help you make your own choice. Actual building plans available for many of the garages shown.



Two-car frame garage amateur can build and getting garage under cover with large sheets of plywood. Both illustrations from the book.

Use This Money Back Coupon

**POPULAR MECHANICS PRESS, Dept. GB-2
200 E. Ontario St., Chicago 11, Ill.**

Send at once, "How to Build Your Own Garage" under your 7 day trial, money-back guarantee. Remittance for \$3.50 enclosed. Send postpaid. Send C.O.D. (U.S.A. only). I will pay postman \$3.50 plus charges.

Name _____

Address _____

City _____ Zone _____ State _____

A Honey of a mower



Worcester Rotor Master®

with leaf mulcher attachment at no extra cost!

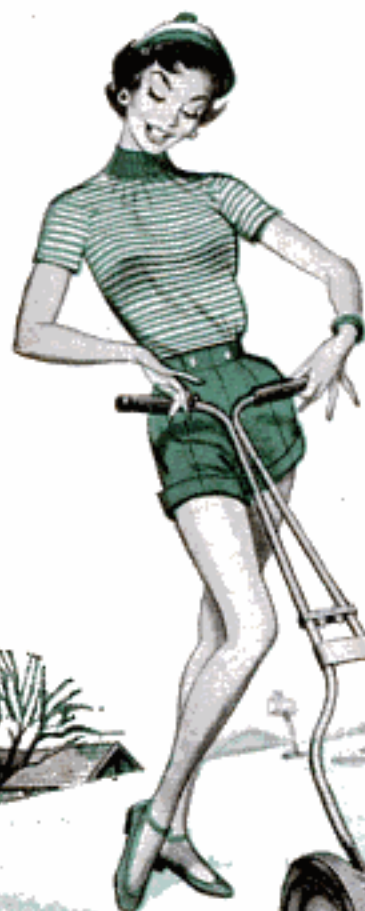

Easy to operate as a vacuum cleaner! New Briggs & Stratton vertical shaft 4-cycle engine is a giant in power yet light in weight. You'll enjoy the new convenience of mowing the toughest, highest grass smoothly and without effort. Wider-than-tread cutting width trims close to fences, trees, walks. Saves hand-trimming labor. Worcester features: "Self-Lube" wheel bearings; durable "Sta-Temp" blade; "Toe-Tip" safety catch on handle, to prevent roll-back on slopes; deep front blade guard; rugged, lightweight, all-steel chassis. At your dealer's, also see the famous reel-type Worcester power mowers, with their

simple cutting - height adjustments, Timken reel bearings, efficient grass guards, enclosed chain drive, adjustable "floating" handle with hill-climber hook, positive fingertip controls. Minimum of upkeep and servicing, because of sound design and sturdy construction.

LEAF MULCHER—Supplied with Models 880 and 830 at no extra cost! Easily attached. Pulverizes leaves to small particles. No leaf raking, carrying or burning.

FREE! Write for Worcester folder on easier lawn care and facts and pictures of full Worcester line of power and hand lawn mowers.



ROTARY ROLL CALL

Worcester ROTOR MASTER®

Model 880 • 20" cut • 4-cycle, 2 hp Briggs & Stratton engine • Model 830 • 18" cut • 4-cycle, 1.6 hp Briggs & Stratton engine.

Worcester DYNA MASTER®

Electric-powered • Model 830E • 18" cut • 1/3 hp • 3450 rpm • UL listed (Plus 2 reel-type power mowers and 4 modern hand mowers.)

Prefer a Reel Type?

Worcester SHEAR MASTER® Model 900 • 21" cut • 1.6 hp Briggs & Stratton 4-cycle engine. Also a model for smaller lawns: the 18-inch 1 hp Worcester POWER MASTER® Model 750.



WORCESTER LAWN MOWER CO. • Div. of Savage Arms Corporation • 84 Broadway, Chicopee Falls, Mass., U.S.A.

MARCH 1954

79

Copyrighted material



A syllogism^{*}.. for all car owners

1 Cylinders wear most at the TOP

2 Chrome plated rings retard wear

3 Therefore TOP rings must be chrome plated to retard cylinder wear

Solid chrome plating on top and bottom rings gives wear protection throughout entire area of ring travel. Only 2-in-1 furnishes alternate HiPressure spring with* every oil ring, for badly worn engines.

No so-called "chrome" piston ring set is complete unless it offers the protection of chrome on the TOP ring as well as on the oil ring! For the top ring operates where *most* wear occurs... where heat is highest, pressure is greatest, and lubrication is poorest!

Because it provides double wear protection... with chrome on *both* the top ring and oil ring... Perfect Circle's 2-in-1 chrome set seals compression and controls oil for over twice as long as old style ring sets! No tedious break-in period, either! So, for thousands of *extra* miles of top engine performance insist upon 2-in-1! Perfect Circle Corporation, Hagerstown, Indiana; The Perfect Circle Co., Ltd., Toronto, Ontario.

Perfect Circle

2 in 1 chrome piston rings

*Deductive reasoning

The standard of comparison



POPULAR MARCH 1954 MECHANICS

WRITTEN SO YOU CAN UNDERSTAND IT
VOL. 101 NO. 3

Mel Koontz

TWISTS TIGERS' TAILS

By Carson Kerr

AS HE HUNG UP the telephone, W. J. "Billy" Richards scratched his head. Turning to Trader Horne, the famous wild-animal trapper, he explained, "Republic wants to shoot a sequence with a leopard leaping at a hunter, only they want it to be stopped in mid-air, as though it had been knocked for a loop by a bullet."

"That's a tough one," observed Horne, who is Richards' partner in the operation of Hollywood's "wild-animal stock company," the World Jungle Compound at Thousand Oaks, Calif. "Still, I wouldn't worry about it. The studios haven't stumped Mel yet."

When they conferred with their chief trainer, Melvin Koontz, he wasn't too optimistic. He pointed out that the leopard, the most unpredictable of all wild animals, is therefore the hardest to handle. However, he'd had some odd requests from moviemakers before and had always managed to meet the requirements, one way or another.

"It would have been simple to have had the cat on a wire, so it could have been yanked back," says Mel now, "but regulations of the Society for the Prevention of Cruelty to Animals don't

Koontz, who trains wild animals for their movie appearances, here coaches a ferocious student—one of Mabel Stark's Royal Bengal tigers. In years of work with the big cats, he's been hurt only once





"Impossible" picture taken at the World Jungle Compound shows natural enemies—elephant, camel, water buffalo, chimpanzee, leopard, black panther, tiger and lion—all obedient to commands of the trainers



permit anything like that. We got what was wanted almost by accident. At best, a leopard merely tolerates a human and, if he happens to take a dislike to you, watch out! The cat couldn't stand one fellow, so I put him on a platform seven feet high, the limit of the cat's leap. Then we turned the leopard loose. When he sighted his enemy, who was jeering and waving a stick at him, he leaped. His front claws caught the edge of the platform, which was just out of the picture. He clung there for a few seconds, then fell on his back. Normally he would have landed on his feet, but the force of the leap threw him off balance. It looked for all the world as if a bullet had caught him as he leaped at the actor on the ground."

Though difficult, this was nowhere near as risky as some of Mel's other activities in doubling for film stars in wild-animal scenes—from the time he pinch-hit for Mae West in *I'm No Angel* (1933) to his performance in place of Victor Mature in the forthcoming *Demetrius and the Gladiators*. He rates the latter assignment as his most hazardous one because he had to appear to kill three different tigers and, therefore, engage in three dissimilar death struggles. While the same tiger, Satan II, was used in each sequence, the wide variation of action increased the danger much more than threefold.

"When Mel previously doubled for Mature in *Samson and Delilah*," Billy Rich-

Big lion, one of Koontz' best animal actors, holds trainer's arm in his jaws and nuzzles him on cheek





Koontz, doubling for another actor, plays role of Daniel in the lions' den for the movie *Slaves of Babylon*

ards recalls, "he did not use a 'safe' cat for the actual combat scenes. The reason for this departure was that Cecil B. de Mille is a stickler for authenticity and he insisted on a continuous shot, showing a very angry lion attacking Samson. When the scene was filmed, the lion leaped with fangs bared and claws unsheathed. For a moment 'C.B.' seemed to think that he was going to get more than he'd bargained for. So did Mel!"

Trainer Koontz is, of necessity, an accomplished actor. In *Slaves of Babylon* he doubled for Maurice Schwartz in the biblical role of Daniel in the lions' den. Surrounded by six big males, he held an attitude of prayer for a full minute. Then without giving the cats a single glance he

Script for another movie, *Samson and Delilah*, required Mel to come face to face with this ugly creature

stepped over the nearest one and walked away.

"Afterward I thought 'What a sap I am to take such chances,'" Koontz comments. "Sure I had some assistants standing by, but they were 30 feet away. Besides, I was wearing a long, black cloak and a rubber mask that made me look exactly like Schwartz. The cats could recognize only my voice, and anything could have happened. They tell me it was most impressive, but I wouldn't know. I never see any movie in which I appear. If I did, I might decide that my work isn't worth the risk involved."

For *Mighty Joe Young*, the sensational film about a giant gorilla of King Kong stature, Mel made possible the scenes where the mechanical anthropoid hurled

Authentic action shot resulted when Koontz, dressed for role, goaded the big cat into leaping at him



Koontz, doubling for Victor Mature in *Demetrius and the Gladiators*, was called on to "kill" three ferocious tigers. Though the same tiger was used in each sequence, the action was entirely different and the job was one of the most dangerous he ever attempted



a live lion across a dance floor, but he almost "goofed" on that one. The cat was dumped from a chute onto a floor built on a 45-degree angle, so that the animal seemed to skid across a level one. In preparing for the first take Mel misjudged the balancing point of the contraption, and both lion and trainer tumbled out. Fortunately the feline's feeling was one of disgust rather than fear or anger. Otherwise, Koontz figures, his career as a cat man could have come to an unexpected end.

What amuses him most in recalling the incident is that the SPCA man on the set seemed more concerned about the cat than the man. Hollywood has rigid regulations ensuring the safety and comfort of animal actors, but no similar provisions for human players.

Having handled the great majority of lions, tigers, leopards and panthers seen on the screen, Koontz has become accustomed to taking chances. Yet, when he reviews some of the risks to which he's been exposed, it makes him wonder. He says he never will understand how he and his protegee, Pat Anthony, got away with a stunt they pulled for a circus movie. The script called for a fight between two trainers with a group of lions looking on. It was something most animal trainers would have refused to attempt, but they doubled for the actors and staged a realistic battle, unmindful of seven cats in the arena with them—any one of which might have joined in the melee at any moment.

Koontz contends that at least 98 percent of the world's wild-animal trainers do it the hard way. With whips, clubs and guns they try to show the animal who is boss. When a cat is crowded with a chair or has

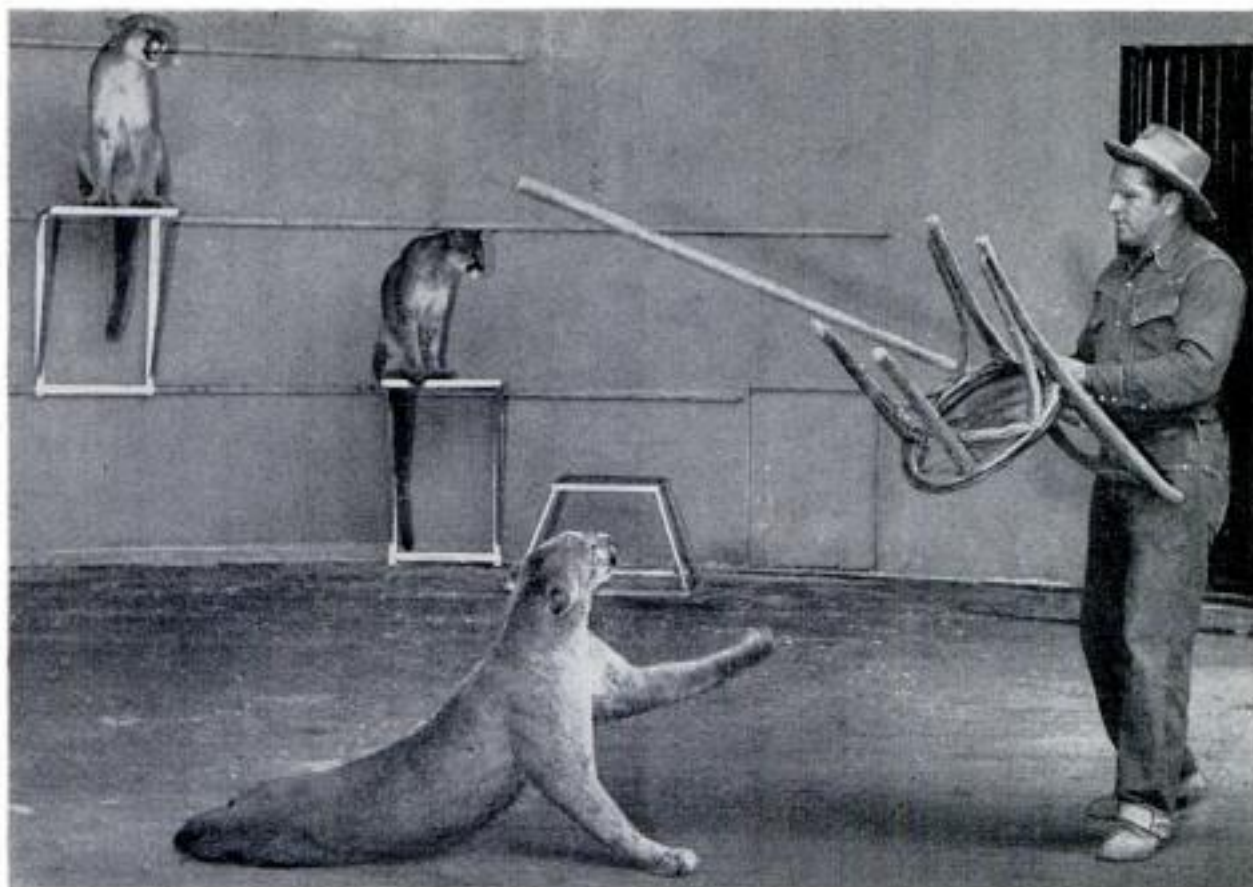

a whip cracked in his face, Koontz feels, its first thought must be, "How can I escape from this character?" Even though he may kill the trainer he's usually just trying to get away from him. Instead of force, Mel uses persuasion, preferring to work with nothing more than a small stick or an old buggy whip and using these more to illustrate his commands than to threaten. He talks his cats into doing what he wants them to do. When a new animal recovers from the shock of such unorthodox treatment, it often becomes friendly.

Koontz is the only Compound trainer who has never been bitten by a chimpanzee. Two chimps that sample other trainers regularly are crazy about him, and sulk if he happens to pass their cages without pausing to play. When he works chimps, he starts by wrestling and kidding them, then demonstrates what he wants them to do and finally says, "Okay, boys, let's go to work!" For him, they perform as willingly as they play.

A trainer who had taught a nervous lioness to take a seat at the front of the Compound area was unable to get her to take the next step and go to a higher platform at the rear. After five days of threatening and scolding, during which the lioness refused to budge, he called on Koontz. Mel went in without even a stick and in five minutes eased her onto a low seat at the back and then got her to take the high one.

(Continued to page 262)

When breaking in new animals, trainer uses stick and chair, but soon discards them to face the cats with his best weapon—his ability to sense their thoughts

Koontz rehearses action scene in the studio jungle setting. Some animals are playful and enjoy his clowning as much as the spectators at the studio





Rear-End Pallet Loader Hoists Bricks on Truck

Pallets loaded with bricks are hoisted onto a truck which mounts a loader on its rear. A power take-off moves the lifting arms, which are lowered so that chain bridles grip under each end of the pallet. The load is swung up onto the bed of the truck. There transfer rollers driven by a second power take-off roll the load ahead. When the truck is loaded it is backed up to the trailer and transfer rollers carry the bricks back to load the trailer. Seven pallets, each carrying 6500 pounds of bricks, can be loaded onto a truck and trailer. Fewer chipped bricks, a

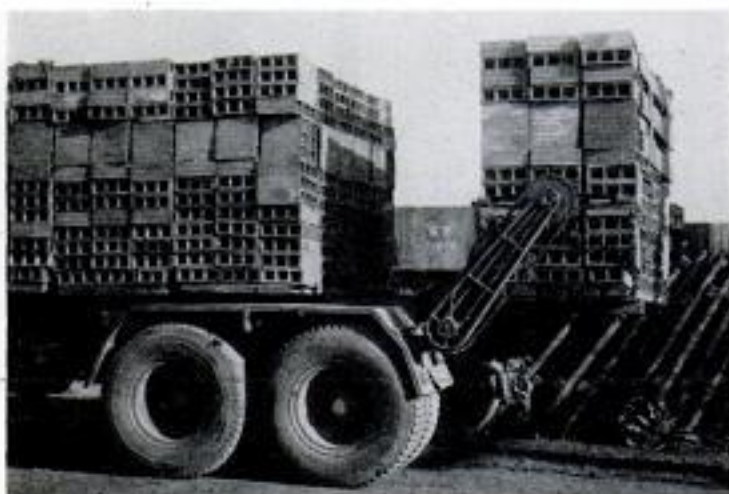

saving in labor and time and "spot" unloading result. The loader was developed by R. H. Berg of San Francisco.

Two Headlights on Power Mower Permit Lawn Cutting After Dark



Now you can mow your lawn at night. One new reel-type power mower has twin headlights that illuminate a broad swath in front of the operator. The lights permit the homeowner to work in the cool of the evening and, according to the manufacturer, help him do a better job because the grass is freshened by dew.

Freezer Aids Surgery

Infected limbs are frozen before amputation with a portable electric freezer used at the Indiana University School of Medicine. A small case that encloses the infected limb is connected to a separate freezing unit. The method is more convenient, less painful and more efficient than the older method, which uses crushed ice.

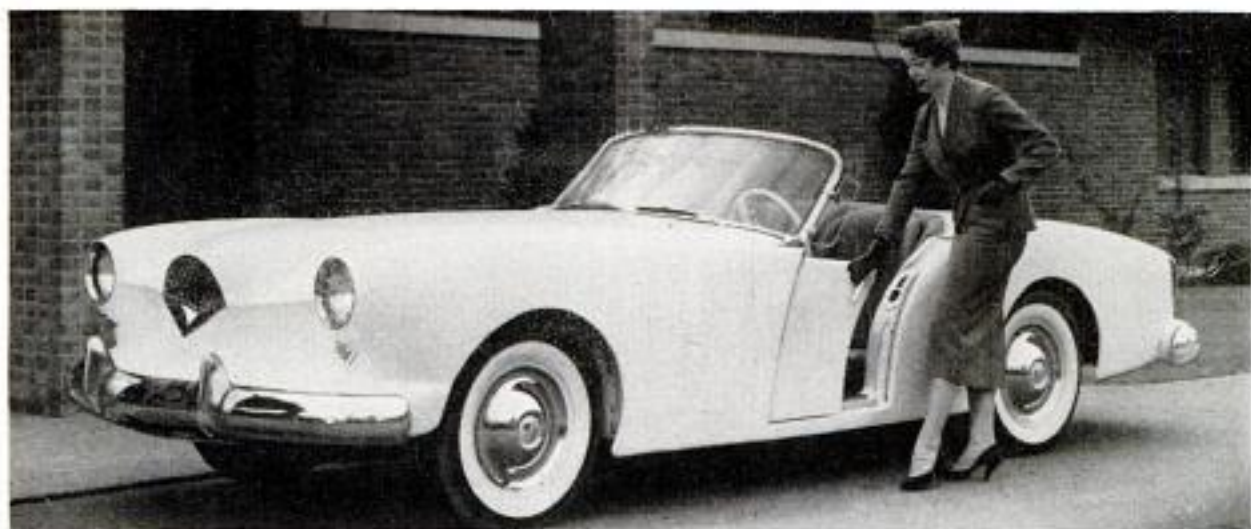

Doors on the sleek Darrin slide forward into the body. The base of the windshield is only 36 inches high



Kaiser Plastic Sportster Goes Into Production

Left, in true sports-car tradition, the Darrin has a stubby gearshift lever mounted on the drive-shaft tunnel. Passenger side of dashboard is padded. Panel contains a tachometer, of course. Below, production of the plastic cars is on a miniature assembly line

LONG, LOW AND SPORTY is the Kaiser Darrin 161—a plastic two-seater that is now in production. Designed by famed Howard Darrin, the all-plastic body weighs only 300 pounds. Almost without ornamentation, the trim sportster is only 36 inches high at the cowl. Doors slide forward to open, facilitating entry and exit when parked in close quarters.

Seats, padded dash and top are embossed vinyl. The front portion of the top can be left open in "landau" style, if desired. A large trunk provides space for luggage and spare tire. The folding top goes down into a separate well.

Powering the 2175-pound plastic car is a six-cylinder 90-horsepower F-head Willys engine.

Now in assembly-line production (but in small quantities because of the hand work required), the Darrin will sell for \$3668. Included are overdrive, windshield washers, white side-wall tires and tinted glass.



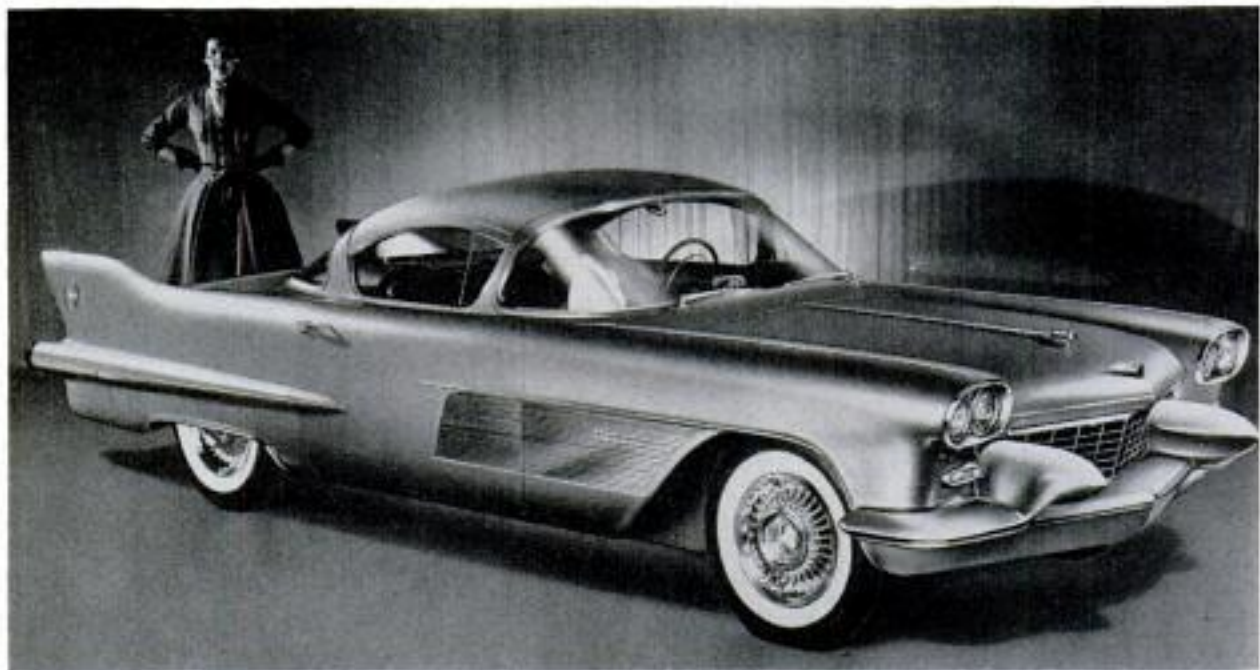

CADILLAC'S car is an aluminum-roofed coupe on which familiar Caddy styling details have been exaggerated

THIS YEAR'S CROP OF DREAM CARS



DETROIT STYLISTS are frustrated—they can't let themselves go on regular models because of price, production and sales limitations. But each year, thanks to plastic bodies (which permit inexpensive single-car fabrication) and a publicity budget, they go all out on an exciting and stimulating crop of "dream cars."

PONTIAC is showing a sports-type car that is called the Bonneville Special after the famed speed track on the Utah Salt Flats

PACKARD displays its Panther, one of few plastic bodies built on a full-size chassis. It has a 275-hp. engine





OLDSMOBILE calls its model the Cutlass. Recessed headlights, high tail fins and a bubble-like top give it a futuristic look. Front-wheel housings are perforated to exhaust engine heat. See page 91 for Buick's Wildcat

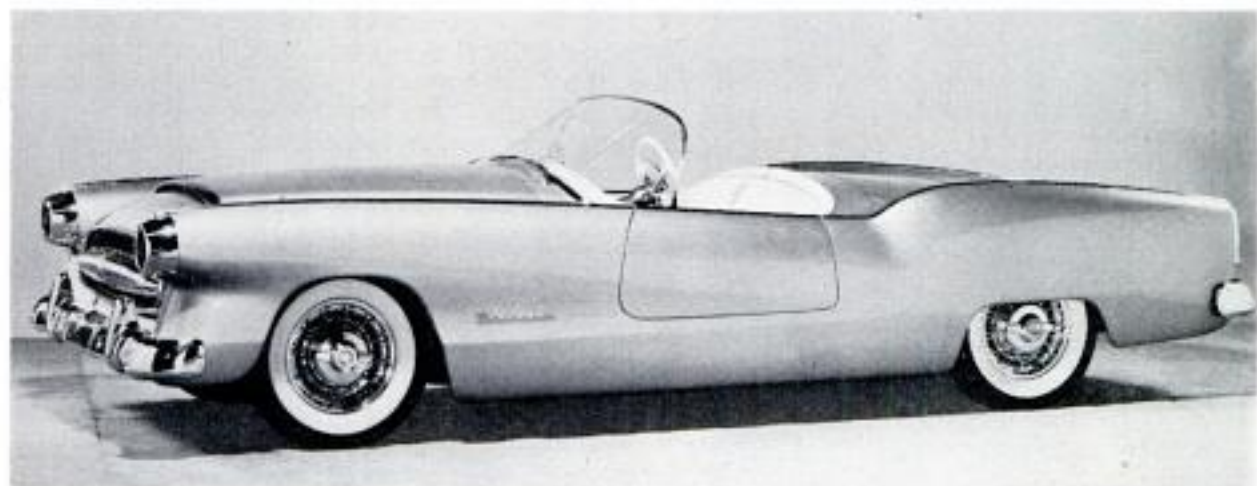

PLYMOUTH put its experimental plastic Belmont on a standard chassis with only minor modifications. **CHEVROLET**, below, is showing an unusual station wagon, the Nomad. Entire rear portion is "wrapped" in glass



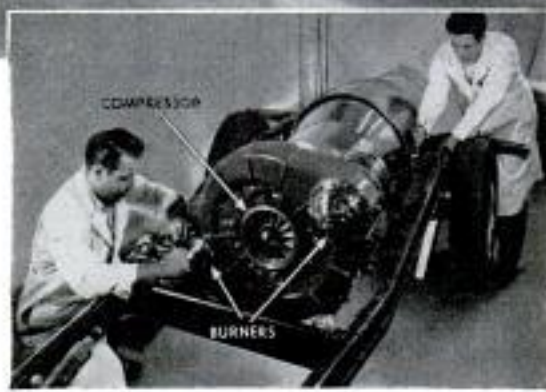
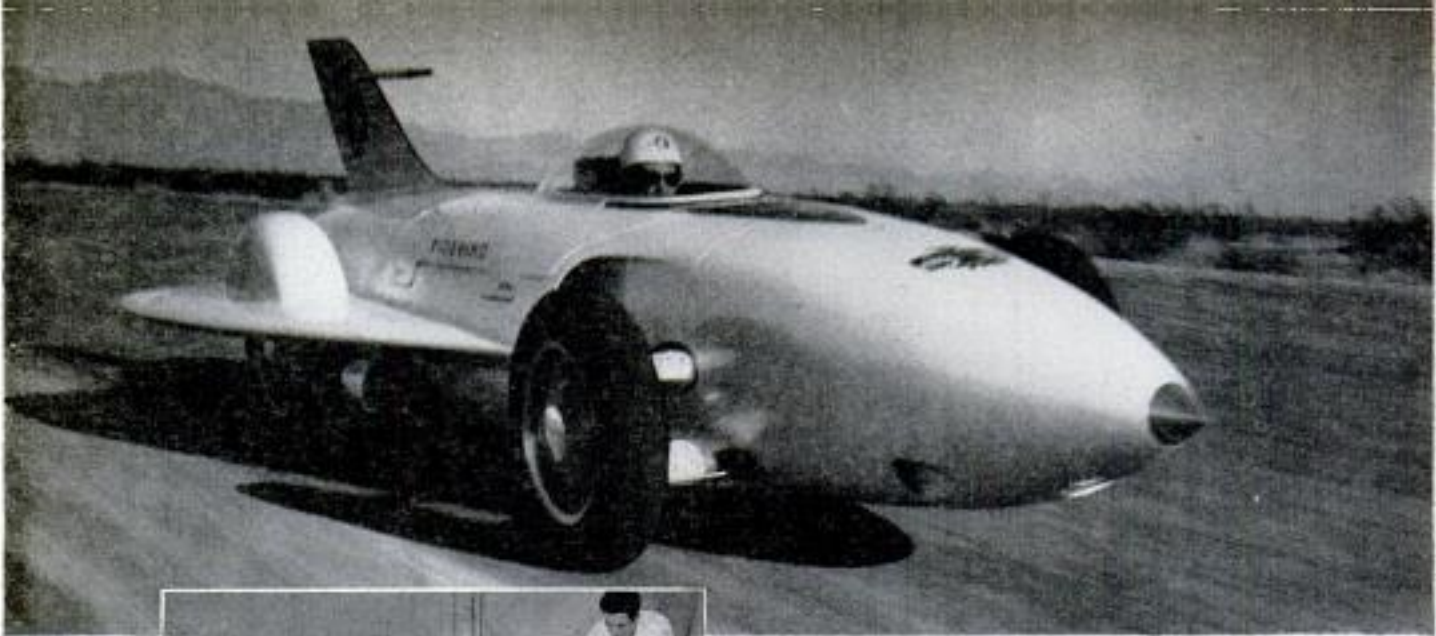

Above, Firebird's chassis. Below, huge exhaust pipe provides no thrust; rear wheels drive car

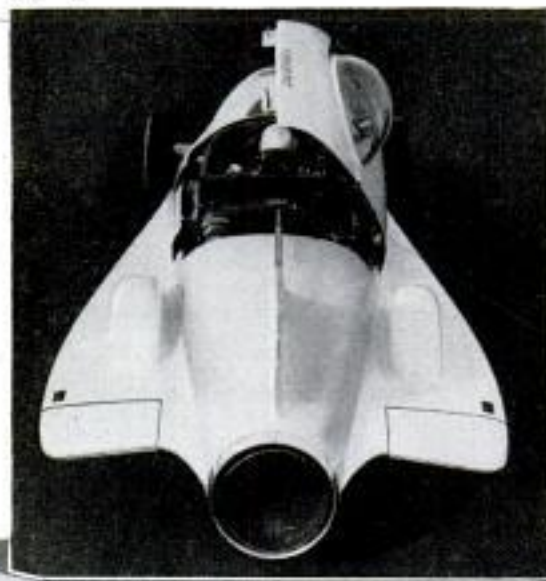

With 370 hp. driving only 2500 pounds, the car should "fly," but as yet its high-speed runs have not been revealed

GAS-TURBINE AUTO

YOU HAVE TO COUNT wheels to decide if the Firebird belongs on land or in air! Shaped like a jet plane, it is described by General Motors as the first gas-turbine automobile built in the United States. You won't see it on the highway today, tomorrow or, perhaps, ever. Strictly experimental, it is driven through the rear wheels, like your car, but instead of a reciprocating gasoline engine, it has a kerosene-burning gas turbine in which expanding gases spin a bladed wheel, much as wind spins a windmill.

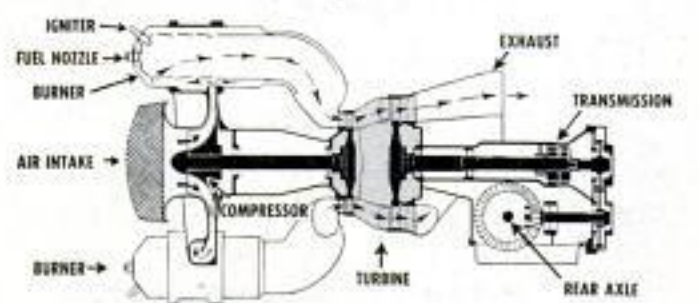

Above, expanding gas from burners spins turbine and the power goes through two-speed transmission to rear wheels. Below, engine is behind driver who sits in a tiny cockpit

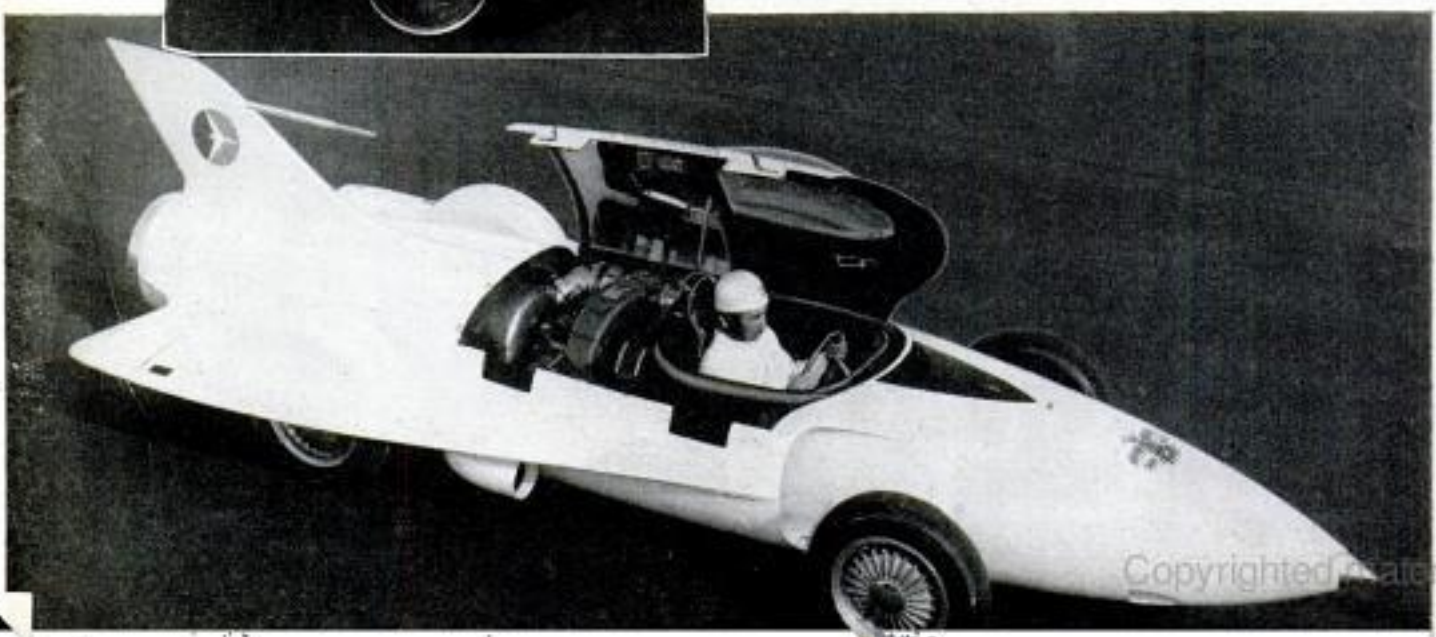

Buick's 1954 "Dream Car" Has Chrome-Lined Fenders

At this time of year, "dream cars" come out like tulips in spring (see bottom of page). Buick's 1954 Wildcat (not for sale) completes a cycle—front fenders are open, showing their undersides as did those on the Model T. However, the 1954 versions are chrome plated. Body is plastic, headlights are on cowl.



Two-Way Telephone Operates on Civilian Ultra-High-Frequency Band



Stewart-Warner Electric Div. photo

Weighing only 28 ounces, a new radio telephone transmitter-receiver operates on the citizens' band at 465 megacycles and has a range of about two miles. Its use requires no technical knowledge and any United States citizen over 18 can easily secure a license for the equipment. Both the microphone and the earphone are of the telephone type and are part of a case which fits the hand so that, in operation, the Portaphone may be used like a telephone handset. Radio signals are sent and received by a folding antenna that plugs into the top.

Sugared Poisons Kill Superflies

Three potent insecticides mixed with table sugar are reducing DDT-resistant fly populations by 90 percent within four hours. Malathion, diazinon and a dialkyl phosphate—all organic phosphate chemicals—are mixed with dry sugar and sprinkled in dairy barns and poultry houses. The method, developed by the Department of Agriculture, safeguards the health of livestock and humans and is low in cost.

Dodge Granada Has All-Plastic, One-Piece Body

Another 1954 "dream car" is Dodge's Granada, a low-slung convertible with an all-plastic, one-piece body, said to be the first in the industry. Previous plastic cars have been assembled from many separate parts. Even the bumpers on the Granada are plastic. It has a conventional Dodge chassis and a Red Ram V8 engine



The OWNERS

What Owners Say About the 235-hp. Engine—

"In case of a tight spot, I have additional power at most any speed." *Salesman, Kaukahee, Ill.*

"I have had to adjust my driving habits to a certain degree." *Welder, Chicago, Ill.*

"Added power is more dangerous. Seems to be no end to the top speed." *Contractor, Portland, Ore.*

"It seems to do everything without effort. There is no ping." *Retired Gunner, Buffalo, N.Y.*

What Owners Say About PowerFlite—

"It is wonderful except for the surge from one gear to another." *Salesman, Bronx, N.Y.*

"Sluggish on the low, low end, but it is fine beyond that." *Distributor, Decatur, Ill.*

"Very good except with a cold engine the car jumps when put in gear." *Salesman, Tunley Park, Ill.*

"Excellent but should have Park position." *Engineer, Valley Stream, N.Y.*



REPORT on the '54 CHRYSLER

The true test of a car begins when the owner takes the wheel. *Popular Mechanics* asked Chrysler owners from coast to coast about their cars. Here is what they say

By Floyd Clymer

BIG CARS AND HANDLING EASE don't usually go together. But Chrysler owners from coast to coast seem to agree that their cars are the exceptions. Well over half of the owners of the largest Chrysler models gave handling ease as the "best-liked feature."

That is a tribute to Chrysler's engineering and to such effort-saving devices as power steering and power braking. Chrysler's power steering is fast. The front wheels respond more quickly than they do on most small cars. That makes the car easy to handle, say the owners.

"So well balanced. Responsive."—Wheaton, Ill., broker.

"A pleasure to handle."—Winter Park, Fla., investor.

"Although my car weighs 4140 lb., it handles and gets around like a much smaller car."—Bennington, Vt., laboratory owner.

"Easy to handle in heavy traffic and in tight places. A dream to park."—Palatine, Ill., salesman.

"The over-all feel is very good."—Alden, Minn., merchant.

These are typical of the responses of owners of the large Chryslers. It is obvious that the cars handle well despite their size.

Of course, there are always exceptions. A Kankakee, Ill., sales manager writes: "The handling of the car is good with one exception. I find with power steering the car line in the center of the road 'throws' the car. On rough roads, steering is not as steady as I thought it would be."

Best-liked feature among Windsor owners (the six-cylinder model) and second best among V8 owners is the comfortable ride.

"Big-car comfort at medium-car economy of operation."—Chicago, Ill., editor.

"I like the ride best. Chrysler builds a

Domed head of Chrysler's hemispheric combustion chamber is shown in this sketch of one cylinder bank

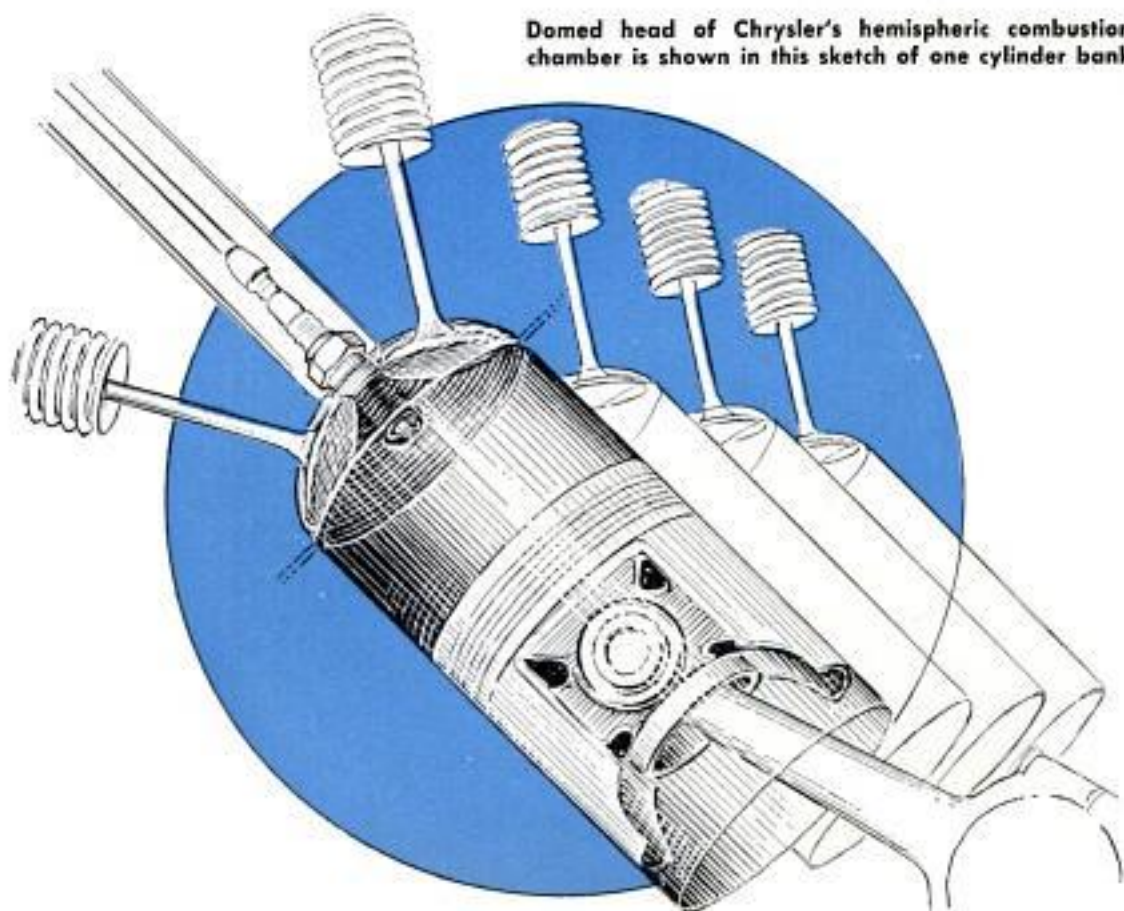

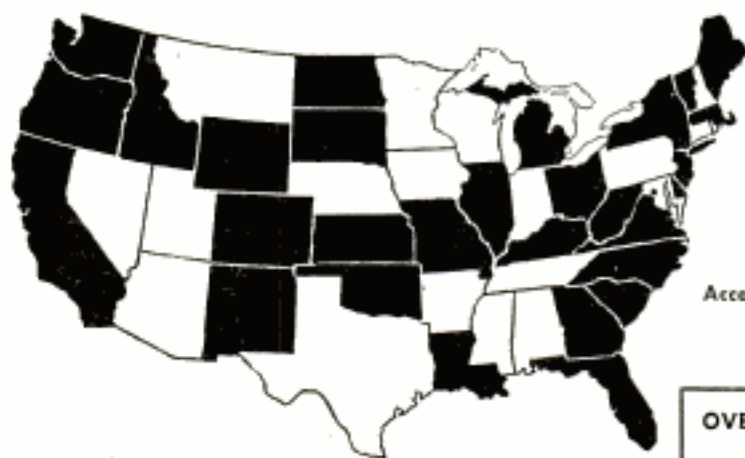

All types of weather and terrain are found in the 29 states from which owners report

Percentages from PM Poll of Chrysler Owners

ALL CHRYSLER OWNERS REPORTING

Previous Chrysler owners.....	67%
Owners of five or more Chryslers previously.....	22%
Owners rating of dealer service	
excellent.....	56%
good.....	25%
average.....	14%
poor.....	5%

Would buy another Chrysler?

yes.....	83%
might.....	15%
no.....	2%

Ratings on particular features

	Like	Acceptable	Dislike
Visibility, forward.....	94%	6%	0%
Riding comfort.....	92%	7%	1%
Visibility, rear.....	91%	9%	0%
Interior styling.....	87%	11%	2%
Exterior styling.....	71%	25%	4%

Chief purchase reasons (in order of frequency)

1. Previous Chrysler ownership
2. V8 engine and 235 horsepower
3. Chrysler reputation
4. Comfortable ride
5. PowerFlite transmission

CHRYSLER OWNERS BY MODELS

	Windsor	New Yorker	New Yorker DeLuxe*
Average miles per gallon			
city.....	14.2	12.1	12.0
country.....	16.7	15.2	15.0
Roadability			
excellent.....	76%	76%	82%
good.....	24%	22%	18%
unsatisfactory..	0%	2%	0%
Handling			
excellent.....	79%	90%	83%
good.....	21%	8%	17%
unsatisfactory..	0%	2%	0%
Structural rigidity			
excellent.....	57%	70%	78%
good.....	38%	28%	15%
unsatisfactory..	5%	2%	7%
Acceleration from zero			
excellent.....	62%	90%	82%
good.....	36%	9%	17%
unsatisfactory..	2%	1%	1%

	Windsor	New Yorker	New Yorker DeLuxe*
Acceleration from 50 m.p.h.			
excellent.....	49%	83%	81%
good.....	48%	15%	18%
unsatisfactory..	3%	2%	1%

OVER-ALL RATING OF THE CHRYSLER

	Windsor	New Yorker	New Yorker DeLuxe*
excellent.....	68%	75%	80%
good.....	31%	24%	18%
average.....	1%	0%	1%
poor.....	0%	1%	1%

BEST-LIKED FEATURES

Windsor owners	
Comfortable ride.....	53%
Handling ease.....	42%
Body styling.....	21%
PowerFlite transmission.....	20%
Performance.....	19%
New Yorker owners	
Handling ease.....	39%
Comfortable ride.....	38%
Powerful engine.....	23%
Performance.....	15%
PowerFlite transmission.....	13%
New Yorker DeLuxe owners*	
Handling ease.....	58%
Comfortable ride.....	37%
Performance.....	25%
235-hp. engine.....	18%
Dependability.....	10%

MOST FREQUENT COMPLAINTS

Windsor owners	
Poor gas economy.....	11%
Poor assembly.....	9%
Rattles and squeaks.....	8%
Rear-view mirror location.....	8%
Flashing-light dash indicators.....	6%
New Yorker owners	
Poor gas economy.....	15%
Sluggish pickup.....	6%
Rattles and squeaks.....	6%
Body styling.....	4%
New Yorker DeLuxe owners*	
Body styling.....	10%
Poor gas economy.....	9%
Rear-view mirror location.....	8%
Rattles and squeaks.....	8%
Owners with no complaints at all	
Windsor owners.....	35%
New Yorker owners.....	40%
New Yorker DeLuxe* owners.....	51%

*Includes owners of Custom Imperial and Crown Imperial models

car that is more comfortable, especially for tall people like myself."—Ridgewood, N. J., clergyman.

"Rides easy. Seats are high enough to be comfortable."—Louisville, Ky., salesman.

"Chryslers can take rough roads better than any car produced."—Ft. Jackson, S. C., soldier.

"Very little jarring on rough roads."—Glen Head, N. Y., businessman.

Handling ease was second among the features best-liked by the owners of six-cylinder Windsors.

But there are complaints too, of course. Owners of the 235-horsepower models (the New Yorker DeLuxe and the two Imperial lines) listed body styling as the most frequent complaint. Ten percent of the owners said they felt Chrysler styling was not what it should be.

"I do not like the body styling. Not up-to-date."—Tinley Park, Ill., salesman.

"Body styling can be improved. And should be."—Buffalo, N. Y., realtor.

"Body styling is behind other cars."—Miami Springs, Fla., secretary.

Most frequent complaint among owners of New Yorker V8 and Windsor 6 models is poor gasoline economy. Many of them blame the low mileage (see percentage chart for averages) on the PowerFlite transmission.

"Too much emphasis on horsepower, speed and gadgets. Too little economy of operation."—Milledgeville, Ga., physician.

"Getting only 15 m.p.g., which is very poor."—Palm Springs, Calif., retired officer.

"Would love to return to the good old 20 miles per gallon. Personally I think the horsepower race is the worst thing that has happened to the auto industry."—Norwood, Ohio, foreman.

"Not up to expectation on gas mileage."—Louisville, Ky., construction worker.

However, there were many owners who couldn't think of a single thing to write under the complaint heading on the questionnaire. Of the New Yorker DeLuxe and Imperial owners, 51 percent failed to list a complaint; 40 percent of the New Yorker owners and 35 percent of the Windsor owners had nothing to complain about in their new cars.

What about 235 Horsepower?

All the V8 models have had a horsepower boost for 1954. The big Chryslers (New Yorker DeLuxe and the two Imperials) now have 235 horsepower, the highest rating in the industry. To find out what owners think about this power plant, *PM* asked them if they considered the added power safer or more dangerous. Ninety-five percent thought it was safer. Some of these had reservations, however, as did the Detroit,

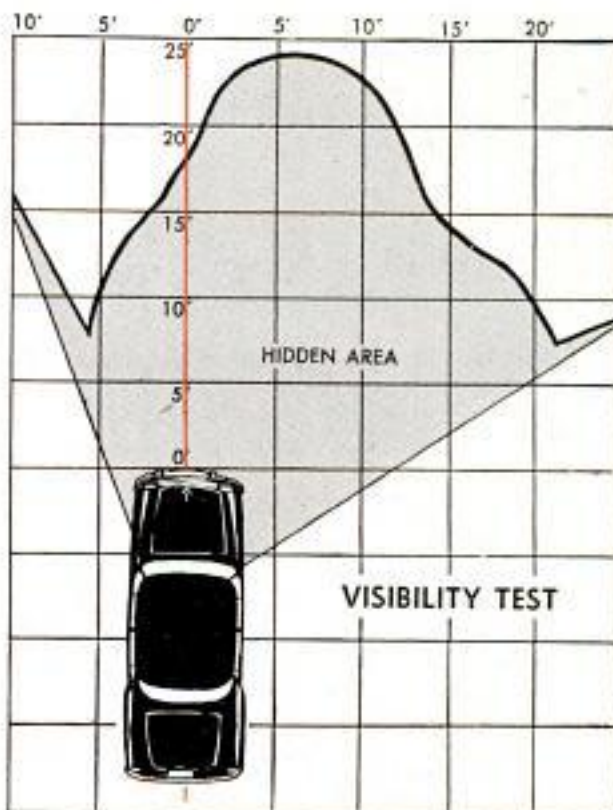

Forward vision of driver from Chrysler is good. The shaded area shows portion of ground he cannot see

Mich., physician who wrote, "The added power is desirable if it is in sane hands."

"I have the power when needed most, such as in passing."—East Rockaway, N. Y., salesman.

"Added horsepower is good insurance."—Arcadia, Calif., machinist.

"Quick acceleration is a lifesaver."—Illinois police chief.

Averaging 89.89 m.p.h. for 2157 miles at Indianapolis, a 1954 Chrysler set a new 24-hour endurance record



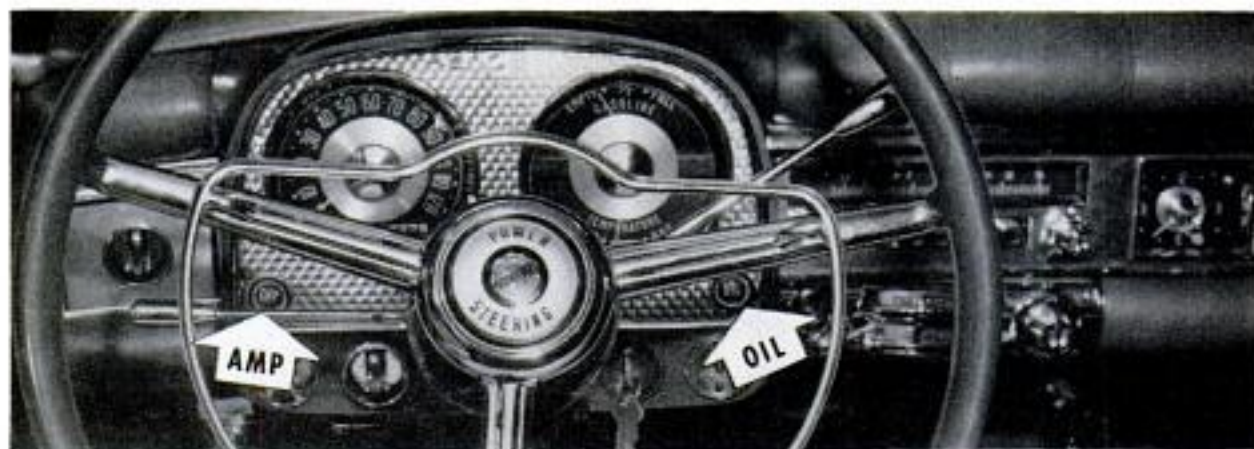

ACCELERATION TEST

1954 CHRYSLER NEW YORKER DELUXE
with PowerFlite Transmission

¼ mile from zero	19.9 sec.	Drive range only
	18.9 sec.	Low and Drive
½ mile from zero	31.2 sec.	Drive range only
	30.6 sec.	Low and Drive
0 to 30 m.p.h.	3.9 sec.	Low only
0 to 60 m.p.h.	14.1 sec.	Drive range only

Top speed by speedometer.....121 m.p.h.
Actual top speed about 7% less

ECONOMY TEST

MILES PER GALLON
Constant-Speed Mileage

At constant 30 m.p.h.	- - -	22.1 m.p.g.
At constant 50 m.p.h.	- - -	19.2 m.p.g.
At constant 60 m.p.h.	- - -	17.7 m.p.g.
At constant 75 m.p.h.	- - -	12.9 m.p.g.

Cross-Country Mileage

*From Los Angeles to Lake Arrowhead and return,
via Mojave Desert (mountain driving) - - - 16.2 m.p.g.

†From Los Angeles to San Diego, then to
Santa Barbara and return (traffic) - - - 16.6 m.p.g.

* Premium gasoline used

† Regular gasoline used



Chrysler now has flashing-light indicators for oil pressure and amperes. Many owners do not like them

What About PowerFlite?

Late last year, Chrysler introduced its new automatic transmission, PowerFlite, which has a torque converter and two planetary sets. It is apparently getting excellent owner reception because every one of the owners reporting in the PM Poll had PowerFlite in his car.

Almost without exception, the owners praised the new transmission.

"Amazing. After driving for 25 years, this is a new experience."—Grosse Pointe, Mich., physician.

"A little noisy in low and reverse, but smooth acceleration without jerk offsets this slight criticism."—San Diego, Calif., salesman.

"Wonderful, except for surge from one gear to another."—Bronx, N. Y., salesman.

"When passing gear is used by flooring throttle, the new V8 really leaps."—Lancaster, Calif., rancher.

"Far ahead of the Fluid-Torque used last year."—Los Angeles, Calif., attorney.

"Should have 'Park' position on shift lever."—Valley Stream, N. Y., engineer.

"Do not like transmission for city driving between 15 and 20 m.p.h."—Montclair, N. J., dentist.

"Transmission has a whining noise, especially in reverse, and vibration at speeds about 50. I would buy another Chrysler, but not with PowerFlite."—Detroit, Mich., machine operator.

"Car creeps. Hum from transmission, especially noticed when in rear seat."—Brookfield, Ill., contractor.

What are some of the other points about which Chrysler owners complain? As in all new-car surveys, there are some who complain of the poor assembly and the resultant water leaks and rattles.

"Rattles in doors and windows. General
(Continued to page 268)

Cowl-ventilator opening is controlled by foot lever under the dashboard. Lever came loose on test car



Front styling of the Kaiser is new. The Manhattan's variable-speed supercharger provides economy and power

Kaiser-Willys for 1954

Kaiser and Willys (products of the same company now) have increased power in 1954. Kaiser has a new front grille, fenders and headlights. The grille is concave and there is a matching smaller grille on the functional hood air scoop. Biggest news is a supercharger, standard on the Manhattan. It goes into operation in response to throttle position, loafing at low speeds to maintain gasoline economy. The Willys Ace has the Kaiser engine of 118 horsepower; the Lark, 90-horsepower F-head Hurricane engine.



Arrow points to belt-driven supercharger

	SHIPPING WEIGHT	WHEELBASE	OVER-ALL LENGTH	OVER-ALL WIDTH	FRONT-SEAT HIPROOM	REAR-SEAT HIPROOM	STEERING RATIO	TURN-CIRCLE DIAMETER	DISPLACEMENT	BRAKE HORSEPOWER AT R.P.M.	BORE AND STROKE	COMPRESSION RATIO	TORQUE RATING AT R.P.M.
KAISER													
DeLuxe	3210	118.5	214	75	63	63	25.0	38	226.2	118 at 3650	3.31 x 4.38	7.3	200 at 1800
Manhattan	3275	118.5	216	75	63	63	25.0	38	226.2	140 at 3900	3.31 x 4.38	7.3	215 at 2400
WILLYS													
Lark	2661	108.0	181	72	61	61	23.7	38	161.0	90 at 4200	3.13 x 3.50	7.6	135 at 1600
Ace	2778	108.0	181	72	61	61	23.7	38	226.2	115 at 3650	3.31 x 4.38	7.3	190 at 1800

Willys Ace has a new grille, larger engine, restyled interior. Automatic transmission is available this year





Early nickel-cadmium batteries failed in extreme cold. Sintered-plate type, frozen in ice, starts car quickly



Production is still slow and involves considerable hand work. Each cell is a transparent plastic case

Here's the Long-Life Battery

FOR TWO YEARS an ordinary-looking sedan has been tooling along the highways and country lanes north of New York City with a "secret" under its hood. Tucked in a space about the size of a breakfast-food box, there is a steel-jacketed battery containing five long, clean cells of clear plastic.

According to the owner, maintenance on his battery to date has amounted to a few drops of water once a year. "It can start my engine at 65 degrees below zero," he claims. "It will take a charge at that temperature, if necessary. But it won't be necessary often. It operates efficiently at 165 degrees above. Excessive running down, no matter how often, won't hurt it—30 minutes on a charger will have it back to total capacity. The automatic charger in the car can bring it up from complete discharge, in fact. And I never have to worry about overcharging it, because it won't take an overcharge. It will deliver power in any position—including upside down, if you enjoy driving that way." On top of all this, the gentleman promises that this particular battery should still be going strong in 1970—and maybe even 1980—long after the car it presently cranks is a dwindling heap of rust.

The car belongs to Dr. L. Grant Hector, director of technical operations for the Sonotone Corporation. The little power source is a new version of the nickel-cadmium-type battery, developed under the supervision of Dr. Hector for his company. And if all goes as planned, Sonotone expects that by the end of 1954 you and I will be able to buy the first automotive nickel-

cadmium battery mass-produced for consumer sale in this country. We'll be able, that is, if we have the price. In return for the 10 to 30 years of service it promises to deliver, the new nickel-cadmium automobile battery's initial cost will run between two and five times the present cost.

"But figured on a basis of cost per year over 20 years of life," says Dr. Hector, "it comes out on the bargain level."

While this is the first such battery ever mass-produced for American car owners, there's nothing new about nickel-cadmium batteries. More than 50 years ago two Swedes, Karl Berg and Waldemar Jungner, discovered that by using positive plates consisting of hollow steel tubes packed with nickel oxide, and negative plates of similar tubes in which cadmium compound was pressed, and an alkaline solution of caustic potash, they had a storage battery with some mighty interesting features. Since it used an alkaline solution instead of acid, they could put it in a rugged steel case. Its plates could not be damaged by overloading or total draining of its stored current. Furthermore, the battery worked year after year, showing no appreciable wear whether used or stored.

Because it was called a "pocket type" battery (due to the steel tubes or "pockets" in the plates), many people thought it was small enough to carry in a pocket. Actually it had to be two or three times the size and weight of a lead-acid battery designed to do the same job. According to some battery experts it didn't do too well in cold weather,

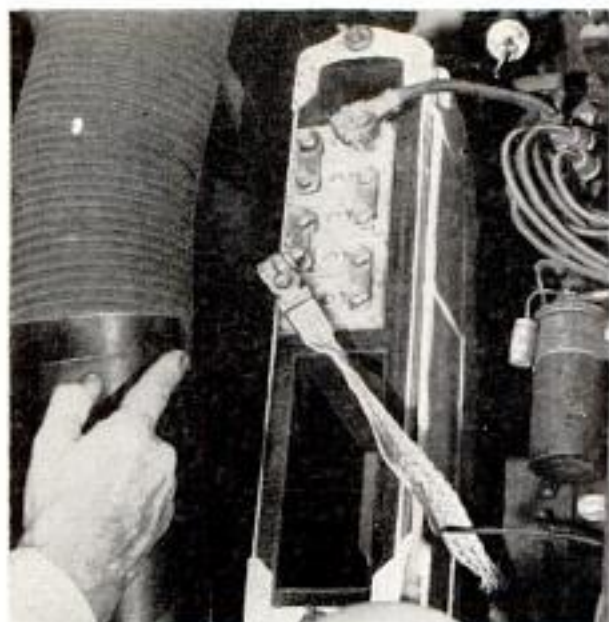

Nickel-cadmium battery is much smaller than lead-acid type, occupying only a fraction of battery rack

either. But for many industrial uses it looked good.

Until recently, most of the world's nickel-cadmium production has been aimed at industry, because of size, weight, price and other limitations of the pocket-type unit. Relatively few have trickled into automotive fields—especially in the United States.

Those that have are adapted to places where size isn't too important. The same set of pocket batteries, for instance, have been turning up a fleet of Northeast Trailways intercity buses for the past seven years. They need water twice a year, instead of twice a day. Clarence Bruce, a Vermont fruit farmer, has one that's been running his tractor for four years. Prior to that, he bought a new battery each year. Now, at the end of the season, he puts his new one on a shelf in the shed, hauls it out again in the spring and off it goes. It cost him three times what he used to pay for each battery previously.

Carl Berg still owns an early pocket type nickel-cadmium battery that has seen duty in automobiles for 20 years. It has been shelved for more than a year, but will still start an engine.

Actually, Sonotone's battery (and a similar one being produced by SAFT in France) is made quite differently from the pocket type. It uses the sintered plates, which were invented by the Germans and first showed up in one of their fighter planes shot down over England early in World War II. Instead of using steel pockets for holding active materials, the grids of the battery are made by sintering nickel powder onto nickel wire mesh resembling the screens on your windows. It comes out a gray, metallic sheet that looks like a piece



Porous, sintered plate is secret of smaller battery. It was developed by Germans before World War II

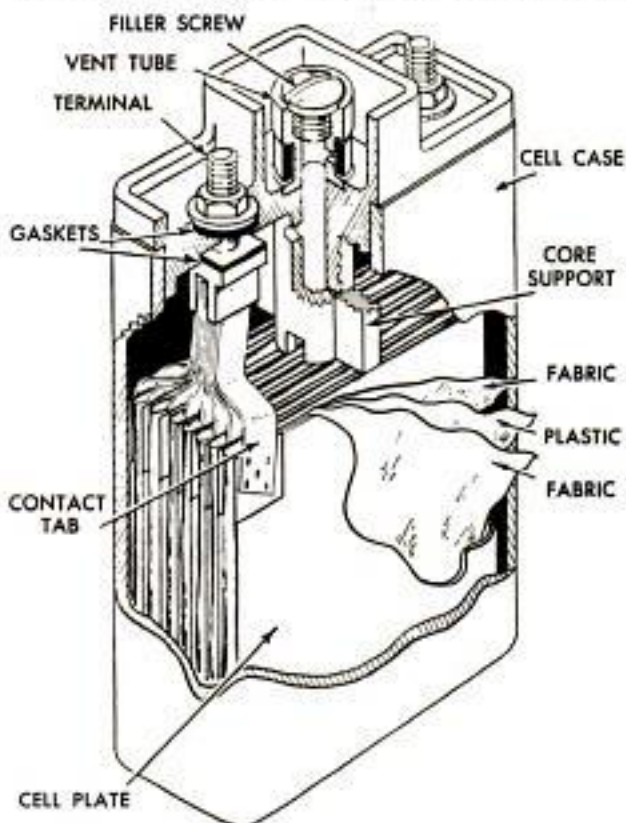

Sectional diagram of cell of nickel-cadmium battery

of emery paper, can be produced in huge quantities and cut to any desired size with snips. Nickel oxide deposited electrolytically in a grid makes a positive plate—cadmium, a negative plate.

"The new grid is as porous as a cinder block," explains Hector. "Hence, chemicals seeping through the holes have a huge area to work on. That's why we can make a much smaller battery do a much bigger job."

(Continued to page 252)

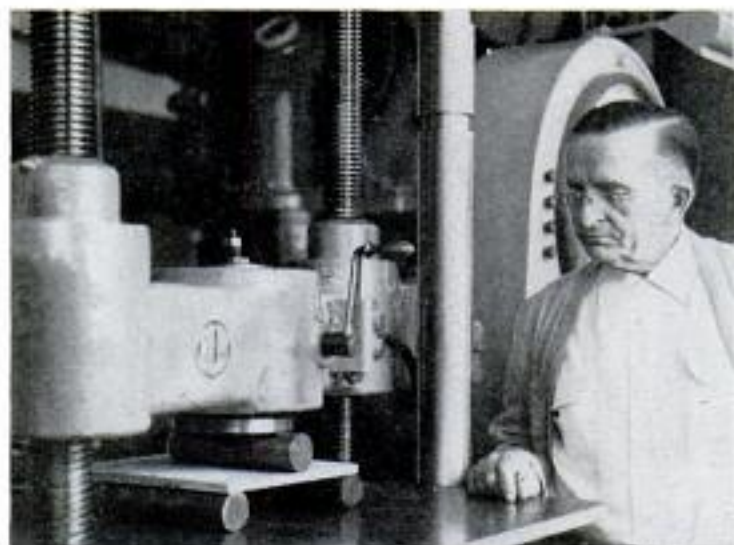

Gilmore watches a strength test of his panel at Oregon State College. Strength proved to be 10 times that of regular plywood

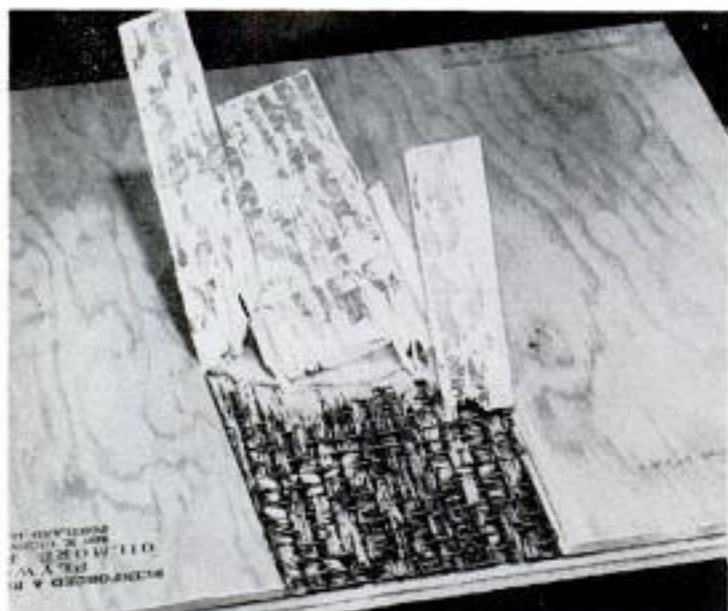

Gilwood after it has been ripped by 6500 pounds pressure in a nine-inch ring-test machine. Wire-mesh reinforcing is exposed in laboratory test. Reinforcing screen has one-fourth-inch mesh

Home craftsmen can work the wood easily with a carbide-tipped power saw turning at 4000 r.p.m. Wire layers don't hurt blade of power saw. Panel has many uses in "do it yourself" field

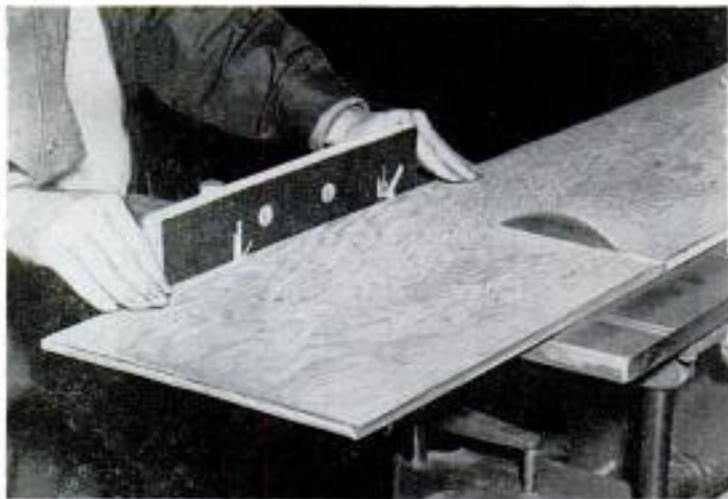

PLYWOOD

With an

IRON SKELETON

WIRE SCREEN bonded between layers of plywood gives tremendous strength to a new wood panel that may soon be on the market. Its backers claim that it will revolutionize the use of plywood in boats and buildings, as well as in packing crates, concrete forms, railroad cars and wherever exceptionally strong, lightweight panels are needed.

The process was invented by Roy E. Gilmore of Portland, Ore., as a result of his efforts to develop a ratproof grain-storage bin. Placing wire screen between the veneer layers of plywood resulted in a panel that was not only ratproof but unexpectedly strong. The development of carbide-tipped power-saw blades in recent years makes it possible to cut the wood-and-metal sandwich without dulling the blades. A home craftsman equipped with such a saw turning at 4000 r.p.m. can easily handle "Gilwood," says Gilmore. Gilwood is his name for the product.

The perfected panel is of standard fir plywood with a soft, black iron-screen core. The screen is like fly screen but of heavier wire and a larger, 1/4-inch mesh. Giving the wire a solid bond to the wood and glue is a sandblasting and coating process. No special machinery is needed to make Gilwood in regular plywood mills.

Tests with 1/4-inch Gilwood at Oregon State College showed its strength to be 10 times that of ordinary 1/4-inch plywood. Variation of strength throughout the panel is 8 percent instead of the usual 35 percent. The wire also stiffens the panels, reducing "give" and flexing. Gilmore states that 1/4-inch Gilwood is as stiff as 5/8-inch regular plywood.

One or two layers of wire mesh will suffice for many uses, but thicker plywoods can have the wire between any or all of five or seven layers, the latter giving exceptional strength for bridge and building trusses. Stainless-steel wire is planned for marine uses.

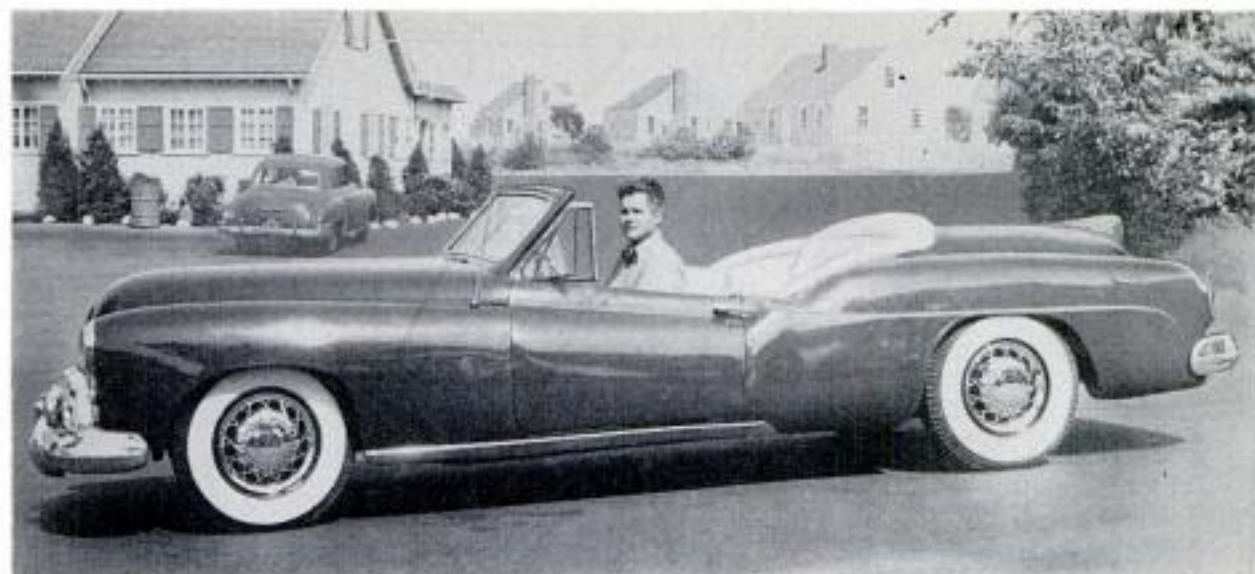

Low-Slung Custom Sport Car Built From 1948 Oldsmobile

With two years of spare time and \$2000, Paul Lauzon of Falmouth, Mass., changed a 1948 Oldsmobile 98 into a sweeping, low-slung sport car. His first step was to cut away the four-door body, beginning at the floor line, after which the floor itself was dropped two inches by channelization. Low clearance was effected by underslinging all coil springs three inches at the front and four inches at the rear. The body is cus-

tom welded, boxed in all the way around, of 16-gauge, cold-rolled sheet steel. The original front fenders were kept, but a 1941 Buick windshield, Buick rear fenders and a Henry J tail fin were used. The steering post was shortened six inches. Seats are foam rubber covered with plastic. Snap-on "wire wheels," white-sidewall tires and 12 coats of paint completed the job. Lauzon owns a professional body shop.

United States Airlines Set Safety and Traffic Volume Records

Scheduled airlines of the United States set a new safety mark of one fatality per 200,000,000 passenger miles in 1953, while flying a record 31,981,000 passengers over

domestic and international routes. The new safety record is compared to 1.8 fatalities per 200,000,000 passenger miles in 1952 and 2.6 fatalities in 1951.

Superheated Welding Rod Melts Stone and Concrete

Stone, concrete, tile and metal melt under the 8000-degree heat generated by a new arc rod which can be used with DC welding machines of 200 amperes or more. The process may be used to drill holes quickly in concrete to expose embedded pipe, to pierce rock for blasting preparations, or cut tile-chimney flues. The new rod creates its own arc, requires no ground and does not have to be struck on metal. A conventional welding machine and the new rods are the only equipment needed.



Normal respiration of the minute long-tailed shrew is 800 breaths a minute and heart-beat rate is 500 to 1300 times a minute, according to zoologists.



"Producers of ideas spread their activities across many fields . . . Kettering might have been satisfied to specialize in cash registers . . . Interested in cars, he licked the problem of a self-starter"

How to Produce New Ideas

By Webb Garrison

ALBERT A. MICHELSON is best known as winner of the Nobel prize in physics. He had many special interests, however. Among them was a passionate desire to solve the many riddles connected with flow of ocean tides.

At the height of his fame, the German-born scientist had a sudden "insight" that gave him a complicated equation for a group of tidal phenomena. It was not produced by trial and error, but flashed into his mind in complete form. When an expert mathematician on his staff arrived at a different result after days of hard work, Michelson refused to permit modification of his formula. Back at his desk, the mathematician found an error in his calculations, corrected it, and labored for hours to duplicate the radical new equation "given" to his chief instantly and effortlessly.

No one knows all that is involved in producing even the simplest idea. Aristotle investigated the subject of originality in the 4th century, B. C. The question has fascinated such diverse thinkers as Immanuel Kant, philosopher; Alfred North Whitehead, mathematician; Carl Jung,

eminent psychologist; and a host of others.

A hunch gave Johannes Kepler the first law of planetary motion; afterward it took him a month to verify it by mathematics. Archimedes did not discover the principle of specific gravity by experiment, but received it as sudden insight while taking a bath. Watt's steam engine made the industrial revolution possible, yet he got the idea on a Sunday afternoon stroll rather than while laboring in a machine shop. When many of the top inventors and scientists of America were questioned by the American Chemical Society a few years ago, 83 percent declared they receive assistance from sudden insight.

Evidence based on analysis of many cases indicates that four major streams contribute to development of significant new ideas. First, there must be eagerness to solve a specific problem. Second, the innovator must have an open mind on a variety of topics. Third, he must make conscious use of relaxation and change. Finally, the prolific inventor must work on numerous projects—must have "many irons in the fire."

Eagerness to lick a problem. On the surface, it seems strange to suggest that emotional fervor can contribute to originality. Yet numerous creative thinkers, especially in the field of mathematics, have mentioned this factor.

Newton received the law of gravitation as a flash of insight. Astronomical observations of 1666 gave results that seemed to disprove it. So he put his formula aside for a time and revived it only when new observations seemed to offer hope of confirmation. Newton was so intensely excited that he was incapable of making the necessary calculations and had to enlist the assistance of a friend. After solving any difficult problem, the great scientist usually felt a wave of emotion so keen he had to abandon work for quite a time.

Jacques Hadamard, noted mathematician at Princeton, flatly declared that strong emotion contributes to mathematical creativity. Henri Poincare, pioneer in study of light and electricity, echoed the sentiment. Bertrand Russell, an original mathematical thinker of modern times, once described insight as "exciting, like quick motoring." Kepler's diary includes numerous references to the strong exultation that accompanied his discoveries.

Charles Goodyear spent a lifetime perfecting treatment of rubber. Bell, Morse and Fulton were willing to push all other affairs aside in favor of their absorbing experiments. Edison could neither eat nor



"Westinghouse was too young to know it couldn't be done, so he invented air brakes for rail cars"

sleep when caught in the throes of creativity.

Almost without exception, the man who produces a new idea has attacked some problem in a spirit of burning enthusiasm. He not only wishes to work on his idea; he is actually incapable of turning it loose. He is so absorbed in his search that every other interest dwindles.

An open mind and keen curiosity. In a literal sense, "there is nothing new under the sun." Every development rests upon previous ones. Devices that we call new are only combinations of two or more old ones. Thus, the ax combines principles of the lever plus the knife. A few mechanical principles, familiar for centuries, were brought together into a radical new combination to perfect the rotary can opener—

which has made several fortunes. Far from starting in a vacuum, Mergenthaler had numerous conventional devices from which to develop the Linotype composing machine. His originality consisted in seeing relationships that had occurred to no one else.

That ability is the heart of invention and originality.

New ideas grow out of old ones by combination and amalgamation. Often the most diverse elements are brought together. Jack Ritty got the idea for the cash register by watching a device that counted revolutions of a ship's propeller. Eli Whitney linked the stripping of cotton seed with the

"Edison could neither eat nor sleep when in the throes of creativity. It was no accident he devised the phonograph in 24 hours"





Drawings adapted from
Hottmann Archives Illustrations

"Absorbing interest in many diverse problems marked the careers of men such as Morse, inventor of telegraph"

claws of a chicken-stealing cat to produce the gin. Newton arrived at the law of gravitation by comparing the abrupt falling of an apple with the perpetual falling of planets toward the sun. Einstein made a leap of thought connecting matter, space and time—to arrive at his theory of relativity. Diesel combined a few standard operations, previously regarded as unrelated, to provide a radical new motive power.

These original thinkers did not restrict their curiosity to a single, narrow field. Nor did they accept prevailing answers as final.

Much creativity is nipped in the bud by simple failure to preserve a seeking attitude. Any expert in a narrow field is likely to try to learn all the facts in his field. His mind may become so fully occupied with the old that there is no room for a new idea.

Veteran railroader that he was, Cornelius Vanderbilt *knew* it was impossible to stop all cars of a train simultaneously. Since hand-braking one car at a time was the only possible method, the old Commodore didn't bother to seek any other system. At 20, railroad passenger George

"Newton was intensely excited . . . After solving any difficult problem, the great scientist usually felt a wave of emotion so keen he had to abandon work for a time"

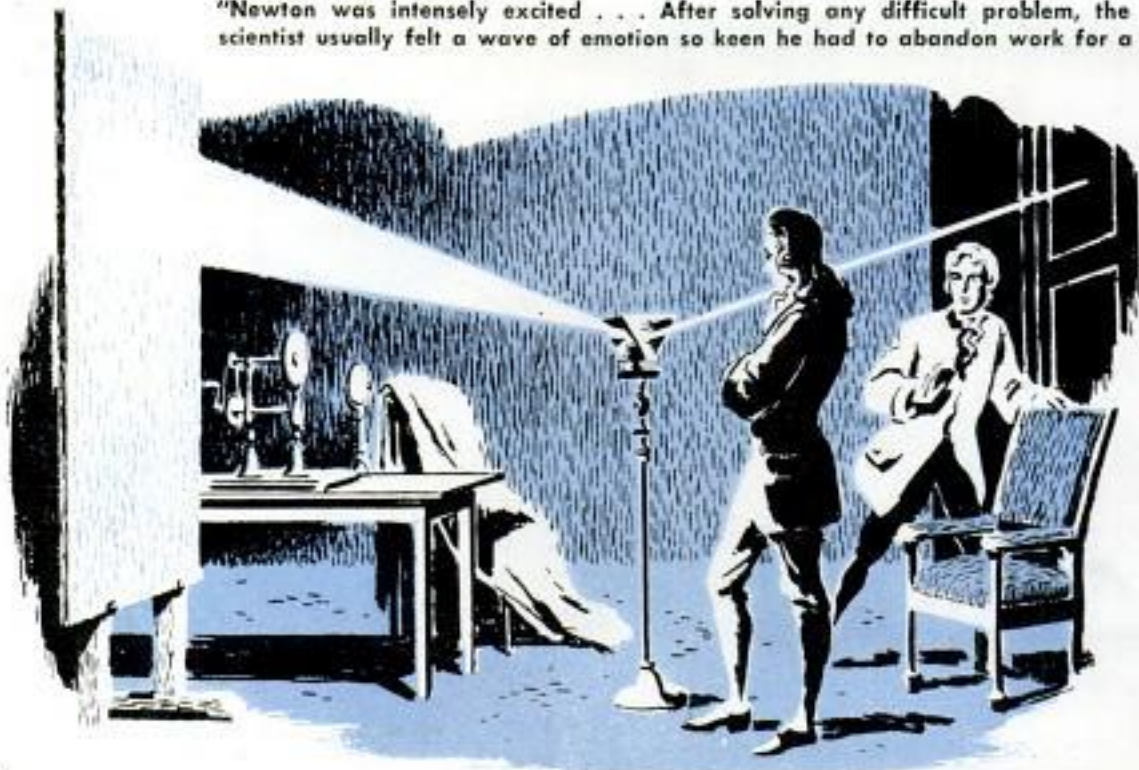

Westinghouse was too young to know it couldn't be done, so he invented an air brake that stopped many cars in a train simultaneously.

It is no accident that many major inventions have come from persons not closely linked with the field in which their originality bore fruit. Day-by-day routines are soon taken for granted. Only the most creative mind ever bothers to investigate the obvious.

In the railroad field alone, rank outsiders have produced many of the most important innovations. Moses Farmer, father of the electric locomotive, was a school teacher. Eli Janney, inventor of the automatic coupler, was a dry-goods clerk. Thomas Hall, originator of the block system, was a cloth manufacturer. And the Pullman sleeping car came from the brain of a cabinetmaker who had turned storekeeper.

To develop new ideas in your own field, set aside definite periods in which to analyze problems as though you were a rank outsider. Suppose you did not already know how to do a particular job; what avenue of approach might be made? If forced to work without standard tools, what devices could you adapt from other fields?

While cultivating an open mind, do not hold a check rein on your curiosity. If you become interested in a problem outside your area of specialization, investigate it. Perhaps that will require a process of learning; if so, all the better! Fertilized by an idea-germ from outside your own field, some piece of old knowledge may bear sturdy fruit.

It is significant that most major producers of ideas have spread their activities across many fields. Richard Gatling, inventor of the machine gun, was not a professional soldier but a country shopkeeper. He devised a steam plow, a rice-sowing machine and a screw propeller. Hiram Maxim, a better businessman than Gatling, made a fortune from his recoil-type gun. But it did not begin to exhaust his interests. Maxim tinkered in many lines and patented hundreds of products ranging from amusement devices to aircraft parts. He even devised a new way to bake beans.

Conversely, the father of fresh-frozen foods

"Goodyear spent lifetime in treatment of rubber"



holds more than 300 patents in the mechanical field. Clarence Birdseye was not content with revolutionizing the food industry. He has perfected devices ranging from a rapid-fire harpoon gun to a widely-used heat lamp.

Charles Kettering might have been satisfied to specialize in improving cash registers. While employed as an engineer for National Cash Register Company, he developed several patents in the field. But when a vice-president of the company was injured trying to crank his automobile,

amateur Kettering became interested in cars. He quickly licked the problem of a self-starter and went ahead to develop a system of ignition and lighting.

Prompted by eager interest in many things, Roger Bacon supplemented the usual studies of a medieval monk by dabbling in alchemy—and produced gunpowder. Georg Cantor studied mathematics from the standpoint of theological curiosity and became a trail blazer in the mathematics of infinity. Elias Howe's interests

"Bell was willing to push all other problems aside in favor of his absorbing experiments"



extended from watch-making to textile manufacture — then he jumped the traces to make a sewing machine for housewives.

Relaxation and change of pace. Enthusiastic, open-minded searching is necessary for originality. Conversely, a period of calm receptivity often pays tremendous dividends—provided it follows a sustained attack upon a problem. The human mind frequently produces originality in periods of relaxation after strong effort.

Many of Newton's mathematical discoveries came to him during sleep. Howe licked most problems of the sewing machine by persistent trial-and-error work, but failed when he attacked the needle. Eventually the right idea came to him in a dream.

John Rust, inventor of the cotton picker, found it easy to get lint on a toothed spindle—but almost impossible to get it off. He was lying in bed, almost asleep, when suddenly the idea of wet-operating a toothless spindle popped into his mind.

Frederick G. Banting was awakened from sleep by a hunch that led to the discovery of insulin. August Kekule, struggling with a problem of organic chemistry, became discouraged and sat down to take a nap. Dozing before an open fire, he began to dream of serpentlike atoms. At first they moved in twisting rows; then each took another's tail in his mouth and a ring was formed. Awakened by the dream, Kekule jotted down his revolutionary closed-chain theory of the benzene molecule's construction. His theory of atomic structure came to him while he was half-asleep on a crowded bus.

There is strong evidence that the mind transforms and modifies much of the raw material fed into it.

Stare at the drawing below. Slowly at first, then more rapidly, the figure will alternate between two and three dimensions. Such shifts of the mind cannot be prevented by any amount of will power. It appears that the mind is ceaselessly at work modifying and transforming the data fed to it by the sense organs.



"Michelson had a sudden 'insight' that gave a complicated equation for tidal phenomena"

Such mental processes seem to continue, at least in part, during periods of relaxation and even sleep. Given an absorbing problem and protected from distractions, the mind tends to find a solution at some level below consciousness.

Many psychologists attribute sudden "illumination" to such a problem-solving process. There are many indications that the mind moves in the direction of order and unity. Given an incomplete or lopsided geometrical figure, the mind tends to alter it in the direction of com-

pleteness and symmetry. Not content with cluttered shelves, the mind seeks to reduce its stock of goods to neat compartments.

As related to the psychology of invention, this means that there is a definite tendency to bring order and form out of any mass of data pertaining to a problem. During hours of intense conscious effort, such movement by the mind is inhibited. Relaxation gives the mind freedom to operate—with the result that a "flash of intuition" may come to a person so vividly and suddenly that it is actually startling.

After reaching a dead end in any problem, deliberate change of pace may yield inspiration. Even a stroll or a nap may be effective. In no instance does relaxation alone produce ideas; it has virtue only as a change of pace following hard work and strong concentration on a problem.

Many irons in the fire. Some problems are solved rapidly—Edison created the phonograph in one day. Other puzzles resist solution for long periods. Whether original ideas come rapidly or slowly, they apparently are produced in direct proportion to the number of problems attacked.

Effective originators do not restrict their interest to a single problem. Rather, they keep many undertakings in progress simultaneously. Here is a problem almost at the point of solution; there is one that has not yet passed beyond the stage of framing a rough question. By working on many ideas at once, valuable by-products from one line of investigation are likely to help the progress of another.

It was no accident that Edison perfected the phonograph within 24 hours of starting to build it. Months earlier, he had failed in

(Continued to page 230)

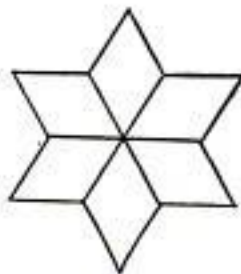

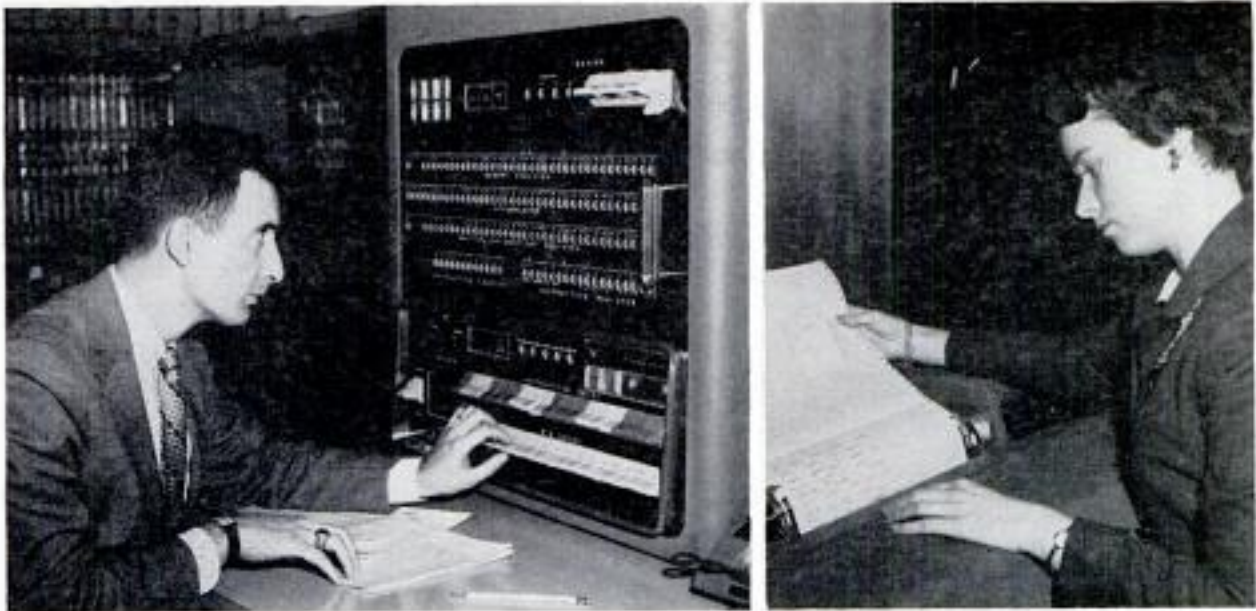

One man supervises machine. English translation unreeals from printer, seconds after Russian is fed in

Electronic "Brain" Translates Russian Sentences Into English

RUSSIAN is translated into English by an electronic "brain" at Georgetown University that normally busies itself with nuclear physics, trajectory-plotting and weather forecasting. A girl who doesn't know a word of Russian punches out the foreign words on a standard IBM machine. The punched IBM cards are then placed in a reading unit. Guided by six basic rules of syntax and grammar, the "brain" searches through its 250-word vocabulary of English equivalents, frames them into a sentence and prints the translation seconds later. Code numbers to various words govern necessary changes like reversing word order, choosing between two meanings and adding connectives. Within five years, it is predicted, such a system will be practical for translation of several languages.



Sentences in Russian are punched on standard IBM cards for feeding into processor for translation

Russian sentence "Obrabotka povyshayet kachyestvo nyeftyi" is punched and printed on card for translation

OBRABOTKA										POVISHAYET										KACHY ESTVO										NYEFTYI									
0	0	0	0	0	0	0	0	0	0	0	0	0	0	0	0	0	0	0	0	0	0	0	0	0	0	0	0	0	0	0	0	0	0	0	0	0	0	0	0
1	1	1	1	1	1	1	1	1	1	1	1	1	1	1	1	1	1	1	1	1	1	1	1	1	1	1	1	1	1	1	1	1	1	1	1	1	1	1	1
2	2	2	2	2	2	2	2	2	2	2	2	2	2	2	2	2	2	2	2	2	2	2	2	2	2	2	2	2	2	2	2	2	2	2	2	2	2	2	2
3	3	3	3	3	3	3	3	3	3	3	3	3	3	3	3	3	3	3	3	3	3	3	3	3	3	3	3	3	3	3	3	3	3	3	3	3	3	3	3
4	4	4	4	4	4	4	4	4	4	4	4	4	4	4	4	4	4	4	4	4	4	4	4	4	4	4	4	4	4	4	4	4	4	4	4	4	4	4	4
5	5	5	5	5	5	5	5	5	5	5	5	5	5	5	5	5	5	5	5	5	5	5	5	5	5	5	5	5	5	5	5	5	5	5	5	5	5	5	5
6	6	6	6	6	6	6	6	6	6	6	6	6	6	6	6	6	6	6	6	6	6	6	6	6	6	6	6	6	6	6	6	6	6	6	6	6	6	6	6
7	7	7	7	7	7	7	7	7	7	7	7	7	7	7	7	7	7	7	7	7	7	7	7	7	7	7	7	7	7	7	7	7	7	7	7	7	7	7	7
8	8	8	8	8	8	8	8	8	8	8	8	8	8	8	8	8	8	8	8	8	8	8	8	8	8	8	8	8	8	8	8	8	8	8	8	8	8	8	8
9	9	9	9	9	9	9	9	9	9	9	9	9	9	9	9	9	9	9	9	9	9	9	9	9	9	9	9	9	9	9	9	9	9	9	9	9	9	9	9

IBM 733727



Watching two different programs on same screen, viewers look through Polaroid windows which divide images

TV Set Shows Two Pictures at Once (It's Done With Mirrors)

DU MONT ENGINEERS are showing off a "double headed" TV set that enables two persons to watch two different television shows on the same screen. The set is actually two receivers in one. One cathode tube in front faces upward. The other is horizontal in the rear of the cabinet with its screen facing the viewer. Between the two tube faces is a slanted mirror which passes light waves from the rear and reflects them from the front. Viewers wear

button-size hearing-aid-type receivers. The mixed images are separated by Polaroid glasses or Polaroid filters placed on stands in front of the screen. One position of the glasses or filters gives the picture on the rear tube. Reversing the position brings in the other picture. With the set, a husband and wife can sit side by side and watch the TV fare they most enjoy. Military men can watch close-ups or long-range pictures of maneuvers.

Diagram illustrates working principle of the unique set. Inset shows switch box that controls channel and volume

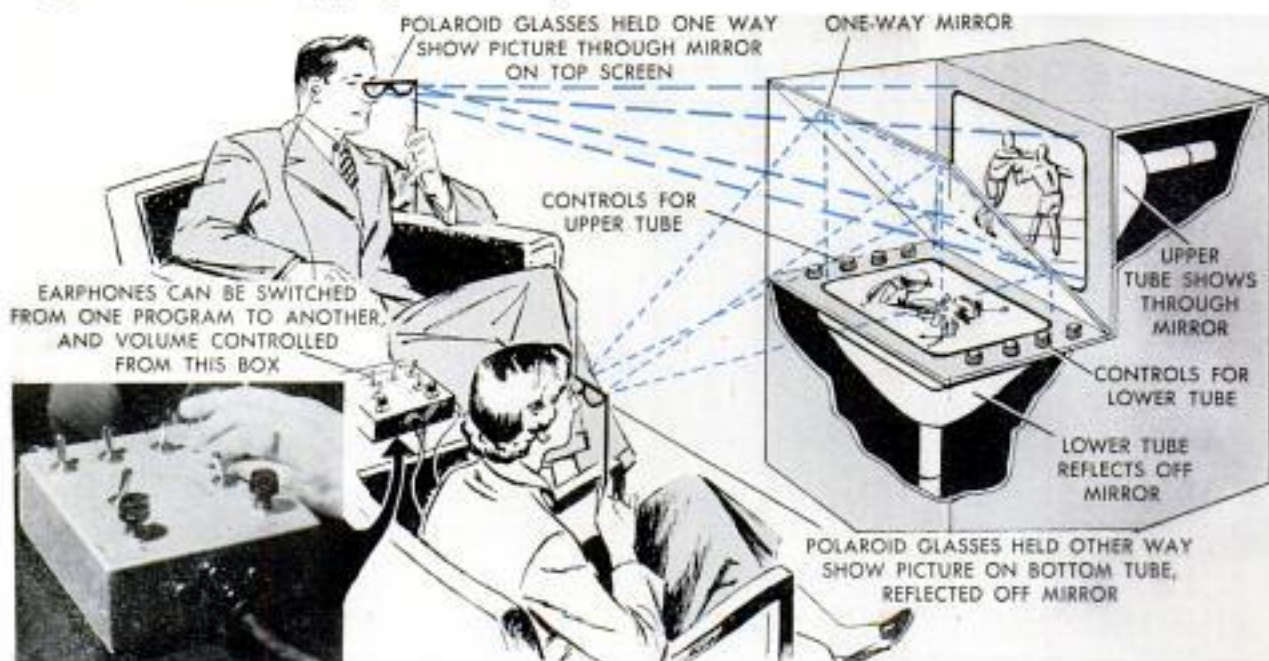

Detroit Listening Post



By Leo Donovan

A MAJOR CAUSE of irritation for motorists soon will disappear. The slow-starting truck that holds up long lines of rush-hour traffic at stop lights soon will surge ahead as fast or faster than the average passenger car when the light changes.

Engineers at GMC Truck & Coach Division of General Motors have developed a 21-speed transmission that enables heavily-loaded commercial vehicles to accelerate from a standing start with alacrity.

Extensive tests have satisfied the engineers that the new transmission (fully automatic) is ready for introduction. You can expect the announcement this spring.

Improvements in the production of automobile windshields in the past nine years have been even more spectacular than the "panoramic view" the salesmen elocute about. Why the glass manufacturers have been so quiet about their accomplishments is a puzzle. Highly complicated machines had to be developed to polish both sides of sharply curved glass simultaneously. Fisher Body engineers, for a long while, were afraid that even if the panoramic windshield could be produced, it would be precarious business trying to fit it into a windshield frame. Now workers use heavy rubber mallets to hammer it into place with scarcely an accidental crack in thousands of fittings. Actually, the panoramic windshield is astonishingly flexible.

The American Motor Car Co. (Hudson-Nash combination) is going ahead with production of the little NKI car that George Mason announced when president of Nash-Kelvinator only. The small cars are being entirely built in England for Nash. They come to this country complete and ready to roll and are, advance notices state, as neat a combination of the advantages of big and small cars as you have seen. The car is very, very small—but very, very good looking.

It started out as the NXI, then became the NKI (for Nash-Kelvinator International), but as of this writing is nameless! Officials are not happy with the three-initial

name (which is familiarly known as Nicky among the Nash family) and are looking for an appropriate new one.

The newest of the Nash family will be announced around the middle of March. It will be available both as a full convertible and a hardtop.

What's the prospect of the gas turbine replacing the familiar piston engine in the next 10 years or so? The GM Firebird (see page 90) prompts such a question. The answer: Practically nil, say most automotive engineers.

It isn't that the technical problems are insurmountable. Even the very-high cost of operating gas turbines at the comparatively low speeds required by today's highways may eventually be reduced. There are other problems.

The gas turbine has plenty of economic opposition, including the big investment in gasoline-producing facilities. The trend toward higher compressions has forced the gasoline companies to invest millions in the production of high-octane gasoline. The turbine burns kerosene and wide-scale use of it would make the petroleum companies shut down much of their equipment.

We'll also have to spend billions in the years to come to bring our highways up to where they will handle the speeds of present-day reciprocating engines. What would it cost to prepare them for the gas turbine?

Buick will introduce a convertible in the new Century line this spring or summer. It will have an even lighter body and the most powerful Buick engine.

Here's an interesting theory advanced by an automobile dealer who believes that many owners pay too large a part of their incomes for cars!

Why not, he asks, sell a form of insurance that will provide the policyholder with everything except the gasoline? Maintenance, replacement of worn parts and future trade-in could be taken care of under the policy.

The amount of the premium would vary according to the type of car the policyholder wants. He could even buy a policy on a used car of a certain value. All repairs would be included in the premium. Thus the policyholder wouldn't have to worry about the cost of extensive repairs on a used car he buys.

The policy could be a "three-year renewable" or a "five-year renewable" or "renewable annually." This would give the policyholder a new car every three years, five years or annually, as he selected when buying the policy. All costs, including license, insurance and perhaps even garage facilities, could be included.

And, if today's trend continues, it might be well to include a place to park it!



Longest trench ever to be explored by archeologists is this 1056-mile pipe-line ditch in the Southwest



Bulldozer pushes away rubble and drifted sand before archeologists take over with a whisk broom
International Harvester Co. photo

PIPE-LINE Archeologists

By Elmer L. Weaver

TWENTY-TON bulldozers seem strange tools in the hands of archeologists whose traditional implements are the trowel and whisk broom. Yet, a half dozen scientists became experts with the big diesel-powered machines and with all types of modern construction equipment as they cleared ancient relics from the path of a "Super Inch" pipe line from Texas to California. This \$175,000,000 line will carry natural gas to the power-hungry industrial areas of California from new oil fields near Midland, Tex., 1056 miles distant.

This pipe-line construction was not only the biggest single project in 1953, it was also the most urgent. The oil producers drilled new wells madly following the discovery of these fields. No pipe line was available to carry away the tremendous volumes of gas that accompanied the oil; so the gas was wasted in huge burning flares. Texas authorities halted production in March, 1953, until this gas could be diverted to a useful purpose and the oilmen lose a fortune every day they wait for such pipe lines to go into operation.





At the archeologists' beck and call were units like this Army truck fitted with compressors and drills

Archeology entered the picture when Dr. Jesse L. Nusbaum, senior archeologist for the National Park Service, pointed out to officials of the El Paso Natural Gas Company that the route of the line went directly through areas littered with relics of prehistoric peoples. These would be destroyed and he requested that competent archeologists excavate and study them before the line was put through. The company cooperated and placed six scientists on its pay roll; it also offered the use of any equipment and men they needed to speed the work and keep ahead of the rushing construction crews. They went even further and supplied funds to publish the reports when the job was finished. The company asked only that archeological work not interfere with construction schedules.

The archeologists went to work immediately following the surveyor crews, who staked out the right-of-way. The entire 1056 miles had to be walked to locate any sites indicated by evidence on the surface. Then these sites were excavated and, finally, the whole distance walked again—this time in the deep trench made to hold the big 30-inch steel pipe. The smooth trench walls revealed sites hidden on the surface by drifted sand and the debris of centuries.

When the actual construction got under way early last August,



Above, after artifacts have been removed from excavation, a map is made of site for files of Laboratory of Anthropology in Santa Fe. Below, model of early apartment house typical of the kind of dwelling unearthed by pipe-line archeologists





While one archeologist assumes position of an early Indian girl grinding corn, a teammate photographs the scene. Below, many pipe-line workers, like the man in ditch, turned amateur archeologists to aid scientists in search for ancient relics

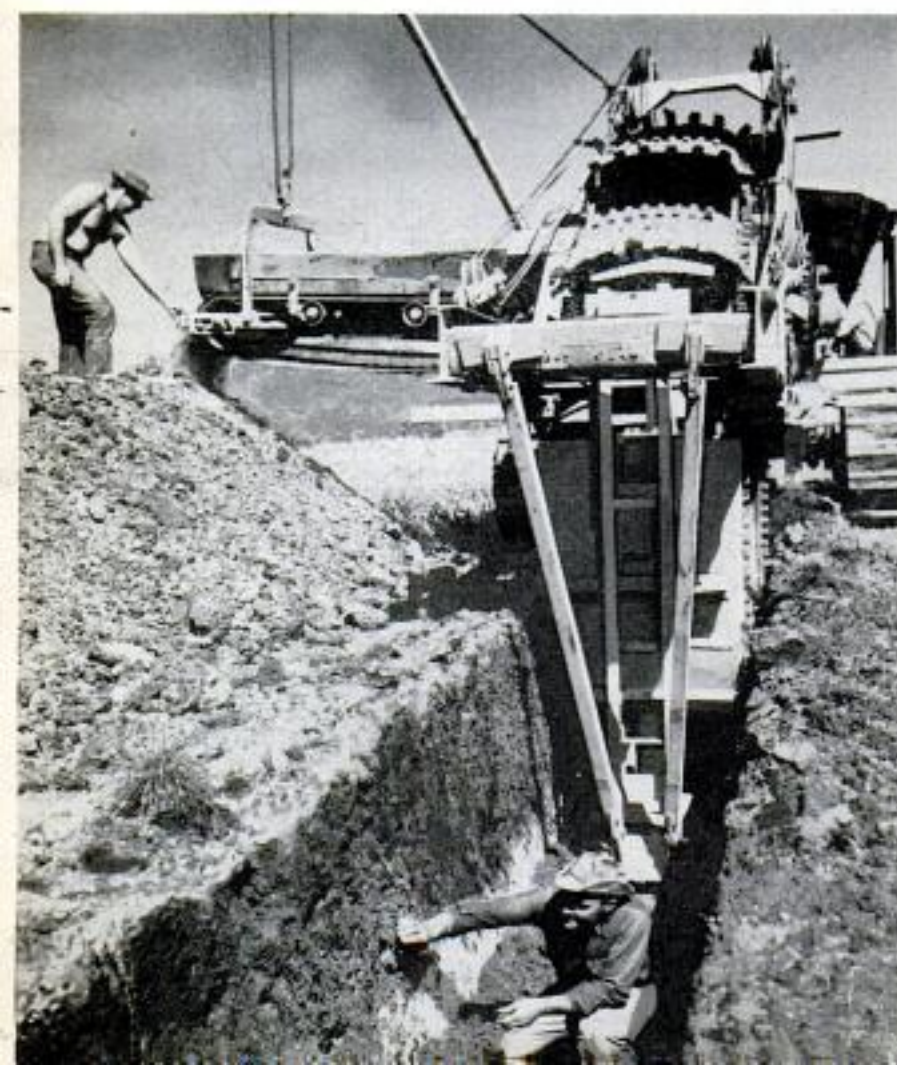

the archeologists frequently had to perform all of the above jobs at the same time. They set up an Army-type command post in Santa Fe, N. M., and by using two-way mobile radio and the long-distance telephone, kept in touch with activities along the pipe line. The reconnaissance work was interrupted many times so they could dash back to rescue a site threatened by the onrushing pipe liners. Using bulldozers saved them days of hand digging by skimming off rubble and sand dunes that had drifted over the sites but, even then, midnight often caught them finishing an excavation by the lights of the Jeeps so the pipe line could proceed on schedule the next morning.

The pipe-line construction men became interested and began to take an active part in the work. When they came upon sites overlooked by the hard-pressed scientists, they would steer their big machines carefully so as not to disturb anything until the scientists arrived. Every large excavation took on the atmosphere of the classroom as pipe liners gathered to watch and the professors explained the finds. They all helped and several left higher paying jobs to join the archeologists for the duration of the project. The search for ancient history changed a routine operation into an adventure.

The archeologists used the pipe-line project to make a cross-section study 60 feet wide, 1056 miles long and containing a sampling trench seven feet deep so they could also see what lay beneath. No private sponsor could ever provide the funds for so vast a survey across the paths of the first Americans. More than 300 ancient sites have been salvaged on the right-of-way for the El Paso Natural Gas Company lines. Each had added its bit of information to the incomplete jigsaw puzzle that is our total knowledge of early man in America. Some day this picture will be complete with every piece in its proper place. The El Paso Natural Gas Company is doing a great cultural service in establishing a precedent that others may follow. The big machinery that has destroyed so many antiquities in the past can help preserve them in the construction projects of the future.

★ ★ ★



Underwater Bike Propels Submarine Swimmer at Rapid Rate

Underwater explorers can scoot about rapidly with a new "underwater bicycle." The device consists of a large metal tube strapped to the swimmer and fitted with a

propeller driven by foot pedals. The pedals are rotated just like a bicycle's. The bike was originally designed for use by Navy frogmen.

Whirling Magnetic Drum Classifies and Remembers Mail Orders

Incoming orders are instantly classified, recorded and totalled by a new electronic and magnetic "brain" which does the work of 39,000 adding machines. It is believed to be the first electric computer specifically designed for business purposes. Dubbed the "Distributon," the instrument was built by Remington Rand for John Plain & Company, a mail order firm which receives up to 15,000 orders a day. Ten girls operate keyboards to send information to the "brain," which instantly records the quantity, the code number of the item, and adds the quantity to the previous total. The information is sorted into 39,000 classifications and "remembered" by a magnetic

drum, which constantly revolves at a rate of 1750 revolutions per minute. The surface of the drum is magnetized in tiny spots to record the information. If an executive wants to know the total orders for a particular item, one of the 10 operators simply punches out the item number and the desired information is available in three-tenths of a second. The machine will give a visual reading on a dial, print or punch the information on tape or punch it on a card. The 10 girls working on the keyboards at top speed can't match the capacity of the machine. Most common errors, such as transposing two digits, are eliminated, as the machine refuses such obvious mistakes.

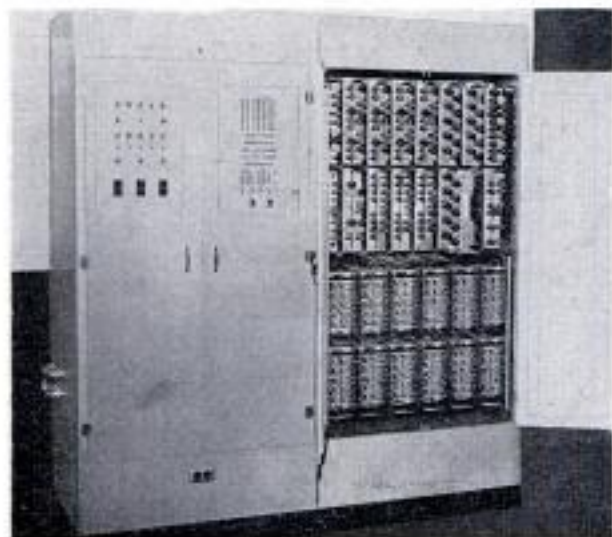

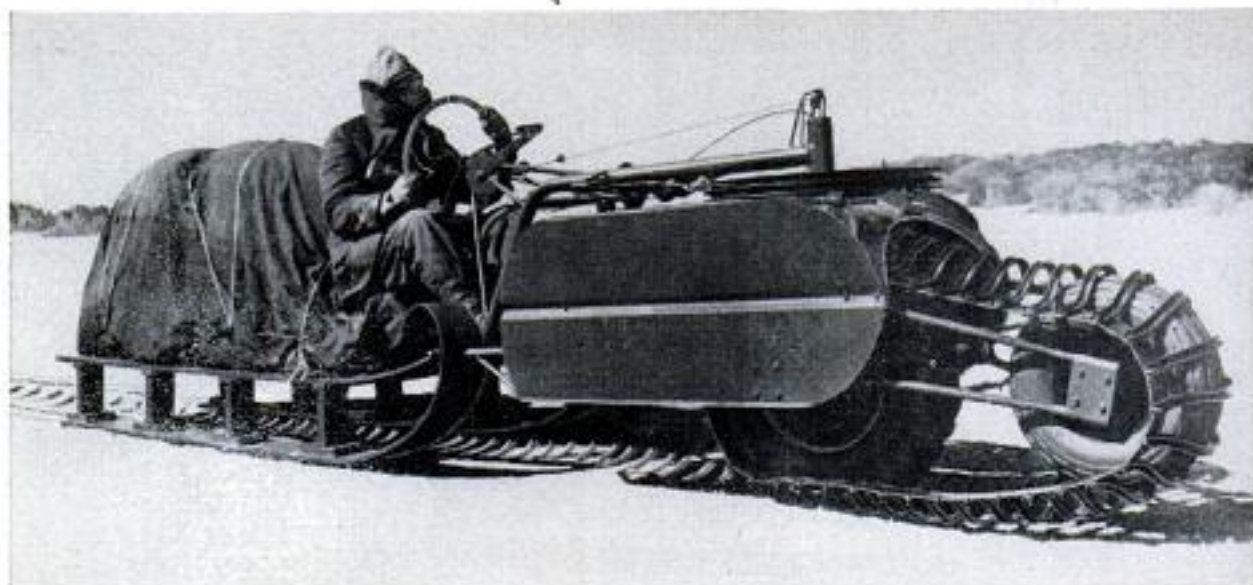

American "Snowmobile" Ends Need for Dogs in Arctic

Eskimos can now dispense with dogs and cruise over the snow in a motorized sled. A "snowmobile" manufactured by a United States firm is driven by a six-horsepower engine that can be detached in three minutes and carried inside to keep it warm

for starting. All parts are built to operate at 65 degrees below zero. Two wheels in front are connected by an endless tread for good traction in snow or ice. The sled is designed to carry 1000 to 2000 pounds in rough terrain.

Six-Second Loader For Spraying Planes

Featuring a beam-hung hopper, a machine developed by a New Zealand aviation firm shoots a ton of fertilizer into a spraying airplane in just six seconds. It reduces the time between touch-down and take-off with a full load to as little as two minutes. Two planes, working in relays over New Zealand's mountainous areas, can spread 200 tons of fertilizer in three days.



Aircraft Plant Installs Wheeled First-Aid Stations

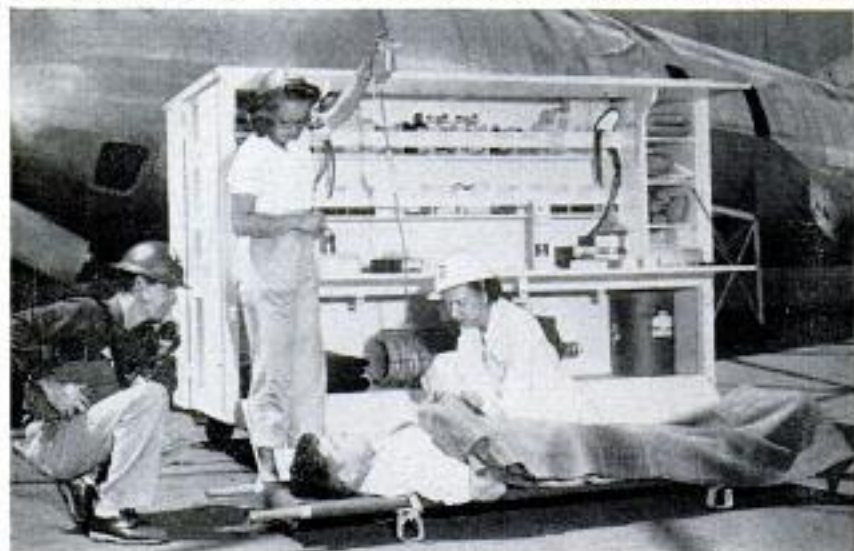

Mobile first-aid stations are kept outfitted and ready for all emergencies at the Consolidated Vultee Aircraft Corporation's San Diego, Calif., plant. Attendants rehearse their assignments during each of the frequent civil-defense drills.

Palomar Mountain's 200-inch Hale telescope is powerful enough to detect the flame of a single candle 18,000 miles away, according to the National Geographic Society.

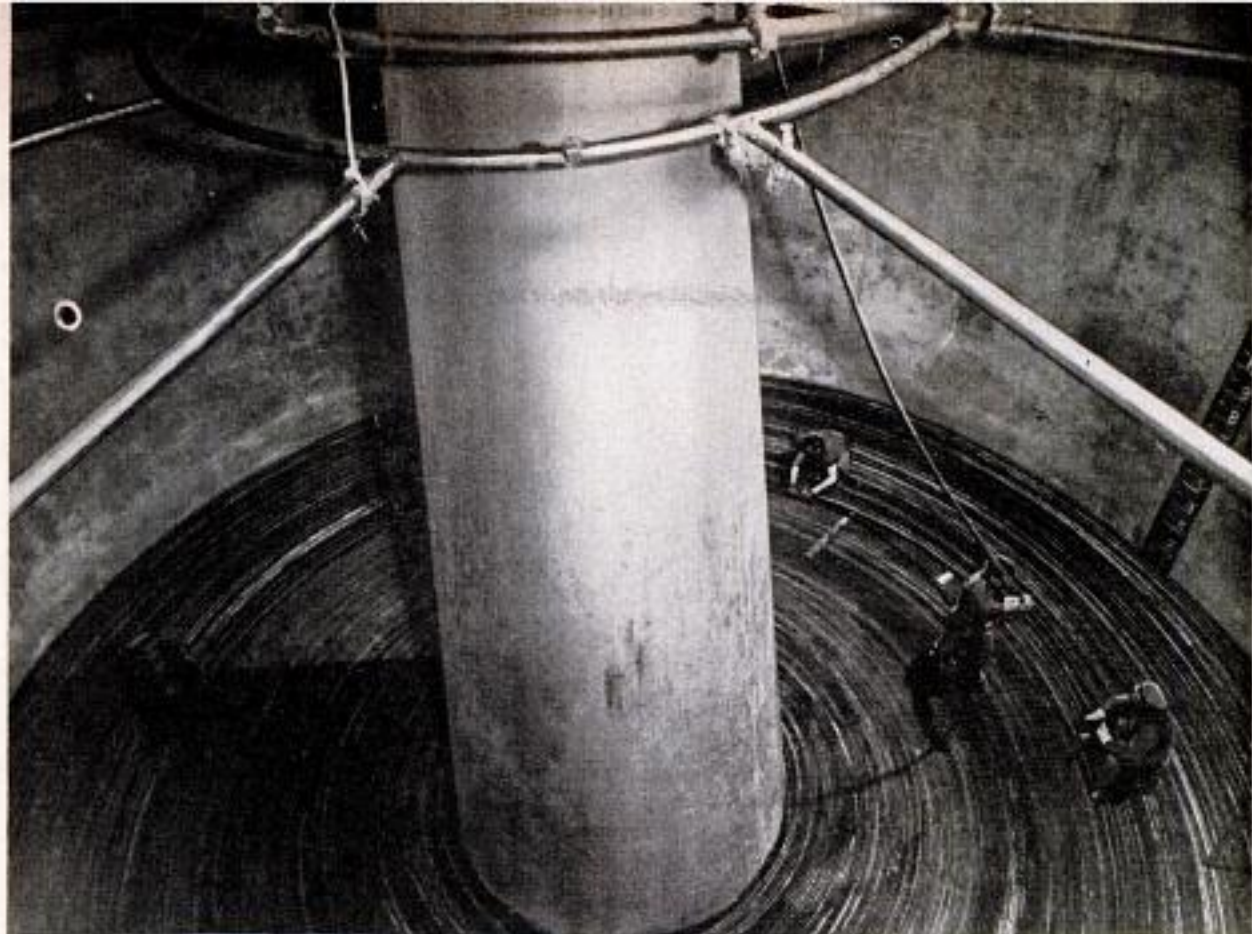

Careful loading of cable on ship takes weeks. Deep-water cable is 1½ inches thick, shallow cable is 2½ inches

Begin First Telephone Cables To Connect the Hemispheres

AMERICA and Europe will soon be linked by the first trans-Atlantic telephone cables. Although the first successful telegraph cable between Europe and America was laid in 1866, this will be the first telephone line to cross an ocean. It will supplement the present 14 short-wave circuits and is due for completion in 1956. Two thin cables will be laid separately on the ocean bottom for 1950 nautical miles between Oban, Scotland, and Newfoundland. An underground cable crossing Newfoundland will connect to an additional 310 miles of single submarine cable between Newfoundland and Nova Scotia. From there, messages will be

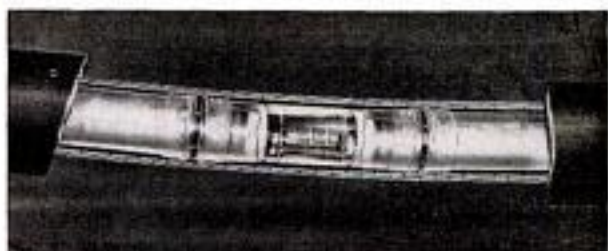

Every 40 miles cable swells to four-inch diameter. A seven-foot row of tiny amplifiers boosts current

carried 350 miles by microwave relay to Portland, Me. The Atlantic link will have 100 amplifiers, each with three vacuum tubes, housed in flexible copper tubing and built into each cable as a tapering bulge that will pass through the ship's gear as the cable is unreeled into the water. The \$35,000,000 line is being laid jointly by A.T.&T., Canadian and British interests.

British cable ship "Monarch" will lay line on uneven ocean bed, which in some places is 15,000 feet deep

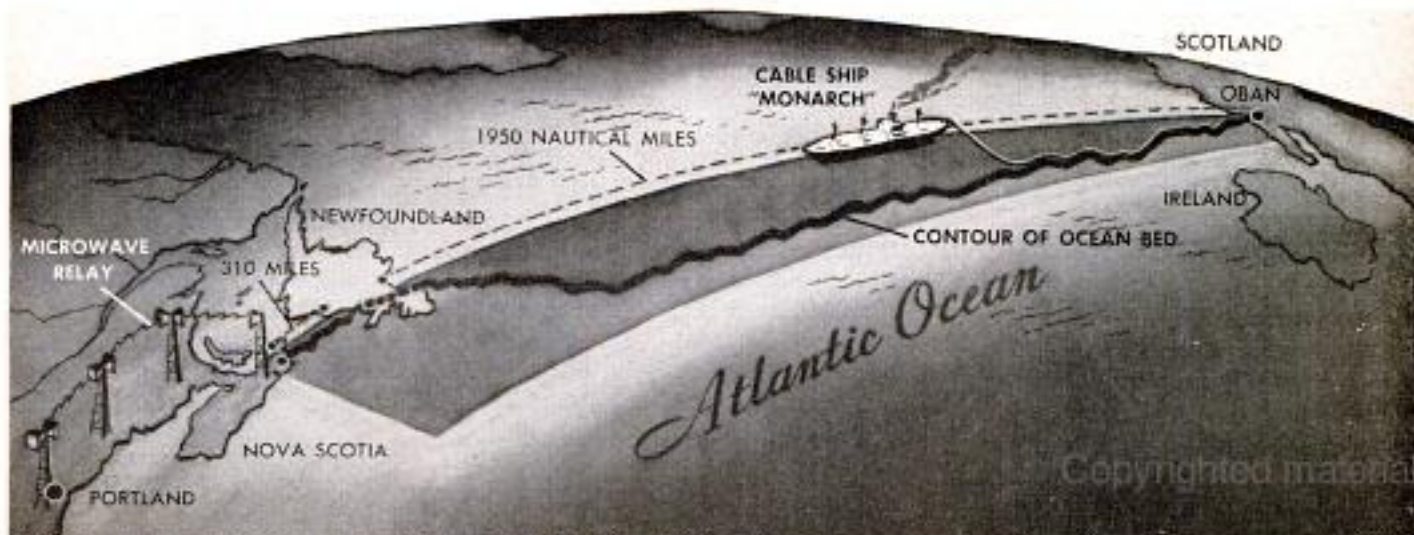



Hot Rod Magazine photo

Jimmy-engined glass-fiber sports car (at left) takes off on an acceleration run at a California drag strip

"JIMMY" Engines for Extra

By Ewart Thomas

THE NEVADA RANCHER had one of the fastest stock cars on the market and you can imagine his surprise when a Chevrolet breezed past him on a desert highway. The rancher put his foot down to the floor but he didn't have a chance. The Chevy was still going away when it disappeared around a curve.

Later he spotted the same car at a cross-road lunchroom and he pulled up alongside. "What are you using for a power plant," he asked, "an Indianapolis engine?"

"Nope," the owner answered, "I have a rebuilt 'Jimmy' engine under the hood. Gives me a top speed of about 120 miles per hour."

Out in California, Joe Rego put a Jimmy engine in his Chevrolet when he had trouble climbing the steep, rocky roads that lead to his mountain lumber camps. Now Rego goes up in high gear with power to spare. He gets three times more tire mileage because they no longer spin on the rocks. In Vermont, the owner of a heavy house trailer installed a Jimmy engine in his car and put an end to the overheating troubles he used to have.

What kind of a power plant is the Jimmy, anyway? It's nothing more than a GMC truck engine. It fits with only a few changes into a Chevrolet's engine space. Reworked for high performance, it can deliver 175 horsepower plus and turns a docile Chevrolet into one of the fastest cars on the road.

Acceleration in high gear feels exactly

like the acceleration you get in second gear with a stock engine. And the Jimmy keeps winding up to 100 miles per hour without a flat spot.

At a drag strip recently, a Chevrolet with a Jimmy engine turned 94 miles per hour at the end of the quarter mile from a standing start, as against the 68 miles per hour it could do with a stock engine.

There's nothing new about putting bigger power plants in light cars, of course. A number of Fords have been repowered with Cadillac engines and these "Fordilacs" have surprising performance. And there's nothing new about the idea of reworking a stock engine so that it delivers more than its original horsepower. But most of this hopping-up has been confined to Ford and Mercury engines. Chevrolet owners had to take the dust of any reworked Ford until speed accessories designed especially for the Chevrolet and GMC engines became available.

Today, if you don't feel like switching to a Jimmy engine, you can rebuild a stock Chevy engine to develop far more than its original power. You can have a "conservative" road job, a "hot" road job, or a "full race" engine that burns alcohol and nitro and is suitable only for competition. The full-race engine is far too rough at low speed for use on the street. The amount of work that you do on the engine determines the kind of performance you get. The basic idea is to increase one engine's capacity to



Horsepower

breathe more air and fuel. This is done in part by enlarging the cylinders, using larger valves and a special cam, and multiple carburetors.

Recently a Chevrolet that had 15,000 miles on its speedometer was the subject of a before-and-after test. As it stood, it could accelerate from 0 to 60 miles per hour in 16.64 seconds. On the dynamometer its engine developed 64 horsepower. Then the engine was modified. Cylinders were bored to larger diameter, over-size valves and aluminum pistons were installed and a camshaft having faster lift was used. Dual carburetors with a special manifold were used as well as a dual exhaust system.

With these changes the engine produced 106 horsepower and the car now accelerated to 60 miles per hour in 11.03 seconds, some 5.6 seconds faster than before.

Reworking and installing a Jimmy engine is more complicated and yet some 2000 Chevrolet owners have done so with happy results. The GMC also fits the Pontiac and Kaiser after engine compartments are modified.

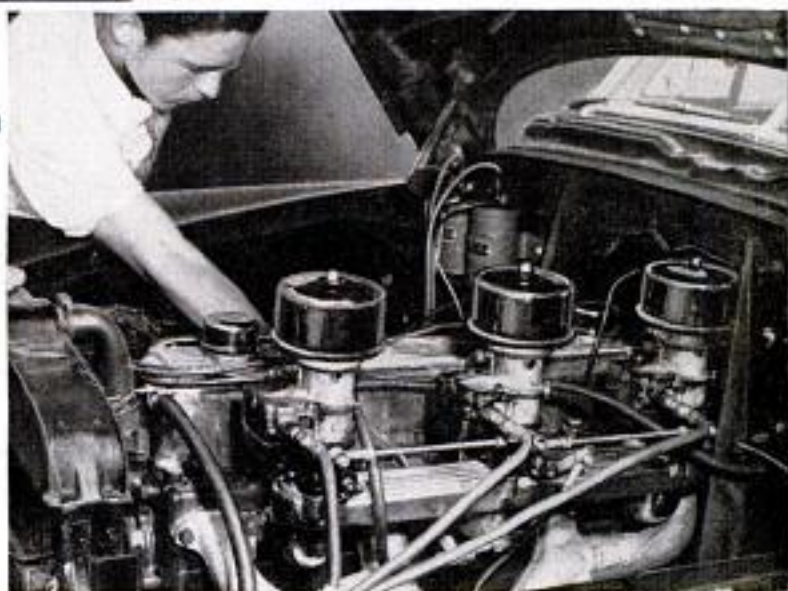

Customized Chevrolet (top) has reworked Jimmy engine (above) with three carburetors. Below, curves show horsepower of various engines. The Jimmy (GMC 270) develops 300 hp. with full-race conversion

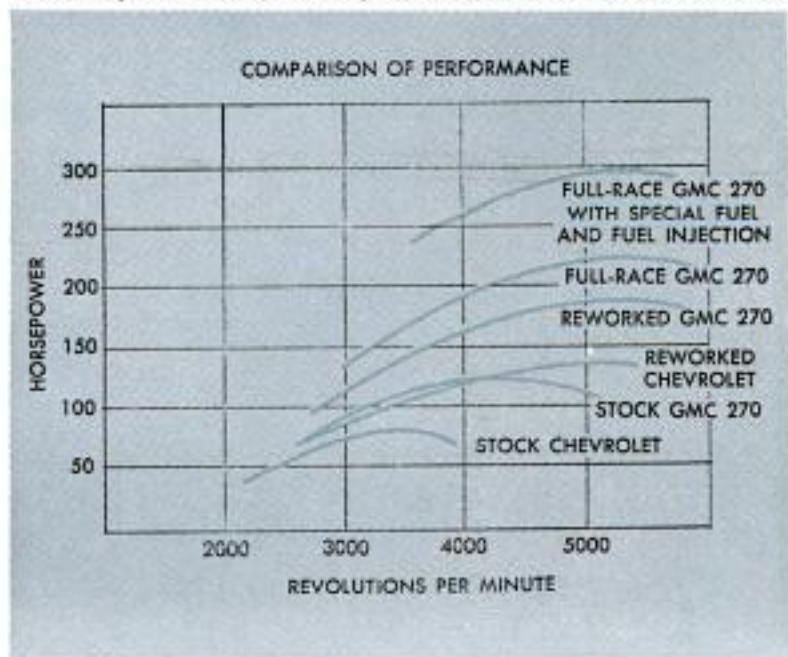



McGurk Engineering diagram

Above, porting intake passages improves performance. Inset shows where grinding is done. Below, engine in competition coupe (bottom) has five carburetors. Car has hit 158 m.p.h.

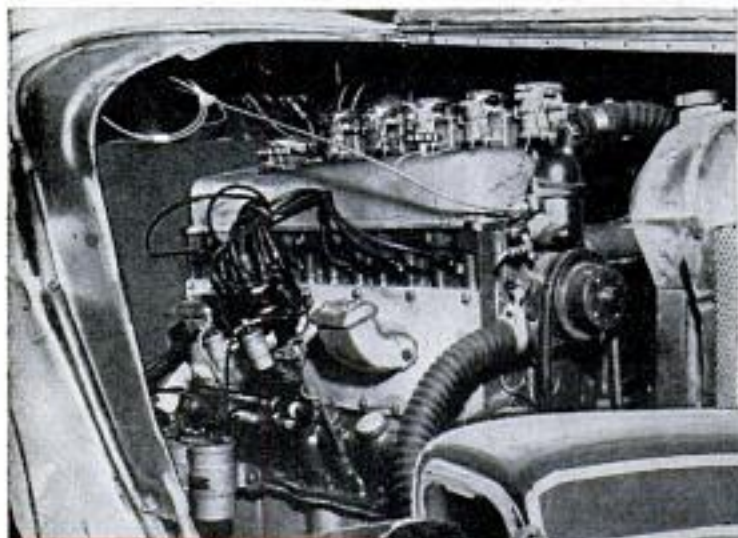

Built for heavy duty, the 6-cylinder overhead-valve GMC line of truck engines have full-length water jackets, full-pressure oiling systems, heavy crankshafts and large bearings. The 270-cubic-inch size, by far the most popular, is rated at 105 to 120 horsepower depending on its year and yet, because of its sturdy construction, can be rebuilt to deliver close to 300 horsepower if the conversion is extreme. For ordinary street and highway use it is best to make changes that produce no more than 160 to 175 horsepower.

The Jimmy develops a lot of torque (having a 4-inch stroke) and so is ideal for hauling a house trailer even without being reworked. It weighs less than 100 pounds more than the passenger engine it replaces and has little effect on front-end handling characteristics of the car.

If you have more money than time you can have a reworked Jimmy installed in your Chevrolet for \$600 to \$800, depending on the amount of work that's done. Wayne Manufacturing Co. of Glendale, Calif., or McGurk Engineering Co. of Inglewood, Calif., will do the job or they will sell you any or all parts so you can do the work yourself. Each company has a booklet available that covers all conversion details. A full set of parts for reworking an engine comes to about \$225.

You can buy a good 270 "short"

block without accessories at a wrecking yard for \$35 to \$55. The first thing to do is have the cylinders bored out to $3\frac{15}{16}$ inches. This raises the displacement to 292 cubic inches and you now use the GMC 302 head gasket. If the engine is an old model with fiber camshaft gears, replace these with the aluminum gears now available. It's best, in fact, to use parts of the latest design while making any replacements. All bearings must be inspected and replaced if necessary and the crankshaft must be reground if worn.

Install special domed aluminum pistons that raise the compression ratio to 8.5:1. Install a $\frac{3}{4}$ -race camshaft. Replace the stock push rods with tubular push rods that don't flex or bend at high revolutions per minute. Valve seats are cut to take oversize valves and heavier valve springs are used. Intake ports are enlarged and smoothed by carefully grinding off the high areas of the walls with a stone attached to a flexible shaft.

Two carburetors for a conservative road job, more for more spectacular performance, and a special intake manifold to fit are required. You may use the stock Chevrolet ignition but for real efficiency you'll need two coils of high output plus a twin-point distributor. Costs start at about \$40.

The Chevrolet starter is hardly strong enough to spin a reworked Jimmy and the easiest thing is to replace it with a 1939-41 Cadillac starter that costs around \$10 secondhand. A LaSalle or a reworked Chrysler starter also works. Another solution is to use an extra battery and run 12 volts through the Chevy starter, wiring that voltage to the starter only.

Late-model Chevrolet flywheels don't fit the GMC and so a Chevrolet 1938-39 passenger or truck flywheel with a 4-bolt flange is used. A GMC 228 flywheel also

fits. Use a 10-inch Chevy truck clutch of the same years. For a full-race conversion, however, a heavy-duty Rockford pressure plate and disk costing about \$20 is recommended. The reworked Jimmy is too powerful for a Powerglide automatic transmission and should be used only with the standard manual transmission.

You need a larger exhaust system because of the greater volume of exhaust gases that are produced. A standard GMC system may be adequate for a conservative road job but better still is a system consisting of split exhaust headers and dual pipes. A pair of stock Chevrolet or Buick mufflers will keep the exhaust quiet.

It pays to change the ring and pinion gears of the rear end to use the greater power. A ratio of 3.73:1 or 3.55:1 is recommended. Either gives you higher road speeds at lower engine speeds.

There are no major difficulties in placing a Jimmy in any 1937 or later Chevrolet. Cars built since 1948, though, have a centered steering arm and to clear this the front end of the GMC oil pan must be cut away and reshaped with a welding torch. Use a 1938-39 Chevrolet water pump and a narrow fan belt that fits the stock Chevy generator.

To install the engine the radiator must be moved ahead approximately an inch. Adapter plates that support the engine on the front motor mounts are available. The rear of the engine fits exactly onto the rear motor mounts and into the Chevrolet bell housing.

To move the radiator, cut off the cross-support bracket that carries the headlight wires and then unbolt the radiator from its U-channel support. Trim away an inch of the lower apron. With a hacksaw cut away some of the metal at the lower-front corners of the U-channel support. Now place the

Oil pan of the GMC engine has to be cut away and reshaped to clear steering linkage on the Chevrolet

Special ignition system costs extra, improves performance. This reworked unit develops about 175 hp.



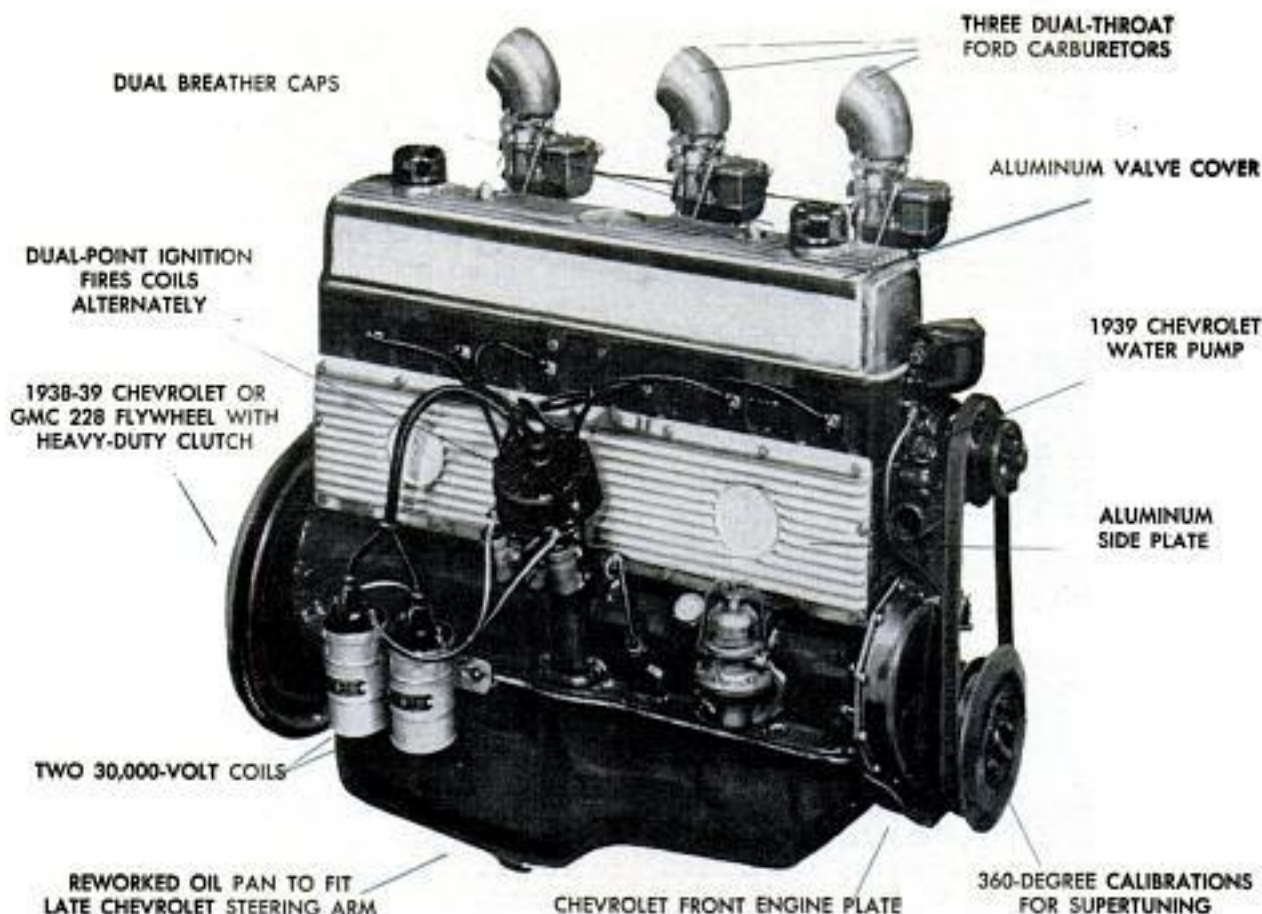

Labels mark some of the changes made on a Jimmy engine for use in a street-driven Chevrolet (not for racing)

radiator in front of the U-channel support instead of in its original position and reattach it to the U-channel by means of longer bolts and spacers. The bolts screw into the nuts that are welded to the radiator flange. The cross-support bracket is now put back in place by welding new ends to it.

This conversion is going to cost you a little of the comfort you have with a stock car. Due to the longer stroke you'll be able to feel the power pulses at low speed, though this smooths out at about 25 miles per hour. The bigger engine is somewhat noisier, unavoidably. It takes more foot pressure to operate the heavier clutch. And, with all that power under the hood, sloppy shifting isn't recommended. You can tear out the clutch or transmission if you try to jam through the gears.

Not only is the Jimmy engine becoming popular for street use and modified stock race cars, it is an outstanding power plant for sports cars and for speed trials. One recent installation was a "full house" Jimmy in a new \$7000 sports car that is becoming a leading contender in West Coast sports-car races. The engine has three side-draft carburetors, a compression ratio of 9.5:1, and is mounted far enough aft in the chassis to put almost 60 percent of the car's weight on the rear wheels.

Last fall a modified coupe with a Jimmy engine turned 158 miles per hour at the Bonneville speed trials and the owner is now reworking the engine again. With peak performance he hopes to add another 20 miles per hour to its speed at the next Bonneville meet. ★ ★ ★

Lightweight Building Block Is Made of Clay

Made entirely of clay, a new lightweight building block has been developed by Armour Research Foundation of Illinois Institute of Technology. The blocks are of standard size (8 by 8 by 16 inches) and weigh 22 pounds, considerably less than cement-bonded blocks. The new ceramic block will not crumble or chip, but can be easily cut or trimmed and nails can be driven into it. In tests, the block has a com-

pressive strength of 1000 pounds per square inch. It has good insulation and acoustical properties and ceramic-block walls "breathe" instead of sweat. The block may be produced in a variety of colors from buff to dark maroon. Development of the blocks was sponsored by the Arabian American Oil Company. Although now made from Arabian clay, engineers believe they could be made from domestic clays.



Lightweight German Streamliner Has Engines at Front and Back

Germany's latest streamliner is a low, sleek, lightweight model with diesel engines at either end. Sixteen inches lower and a foot wider than standard German

trains, the train consists of seven jointed sections, 58-foot engine cars and 40-foot passenger cars joined over common axles. Made of aluminum, it weighs 88 tons.

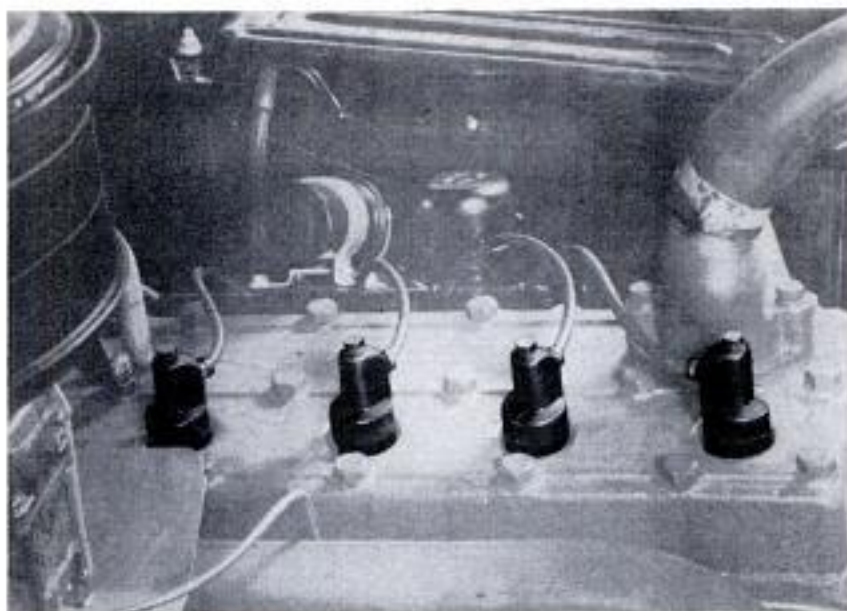

Ceramic "Towels" Dry Spark Plugs

Gasoline engines will operate under the dampest conditions when spark plugs are protected by a rubber-covered ceramic cartridge. The cartridge absorbs any moisture which gets under the rubber cover. Engine heat dries out the cartridge, renewing its absorbent qualities. The covers are especially designed for use in coastal areas where fog and other airborne moisture frequently short ignition systems.

Double-Jointed Fork Truck Tested in Korea

There's very little a new Army fork truck cannot do in the material-handling line. Being tested at a Korean port, the truck has a maneuverable fork that can be lifted, tilted or pushed forward while carrying a load. It is designed to negotiate 24-inch-high obstacles without unbalancing its load. Low-pressure tires permit operation in rough terrain or sand.

During 1953 the domestic airlines of the United States carried nearly 1,500,000,000 letters.



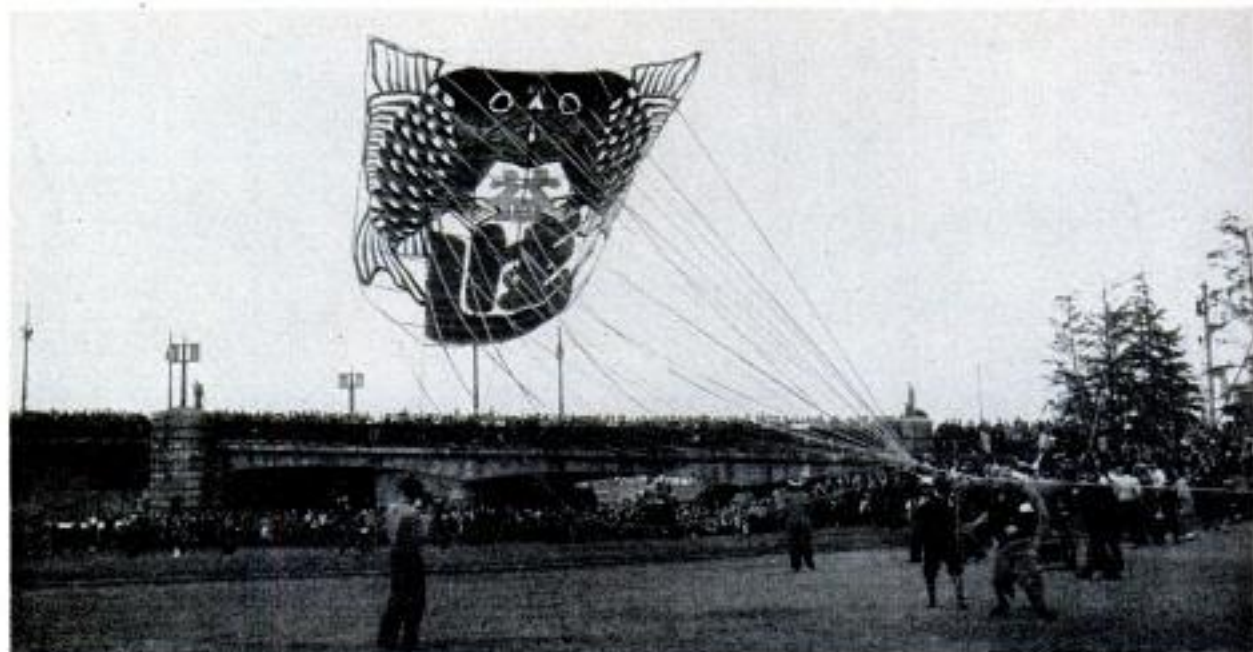

Gigantic Japanese Carp Kite Requires 200 Anchor Men

Two hundred men were needed to fly a giant kite launched in Tokyo. The kite, 36 by 39 feet, weighed 560 pounds and was painted to resemble the carp, Japanese

symbol of courage. It was used to celebrate the recent national Medium and Small Industrialists' Conference and carried the motto "promoting the public interest."

Midget Diesel Bike Engine Gets 300 Miles Per Gallon



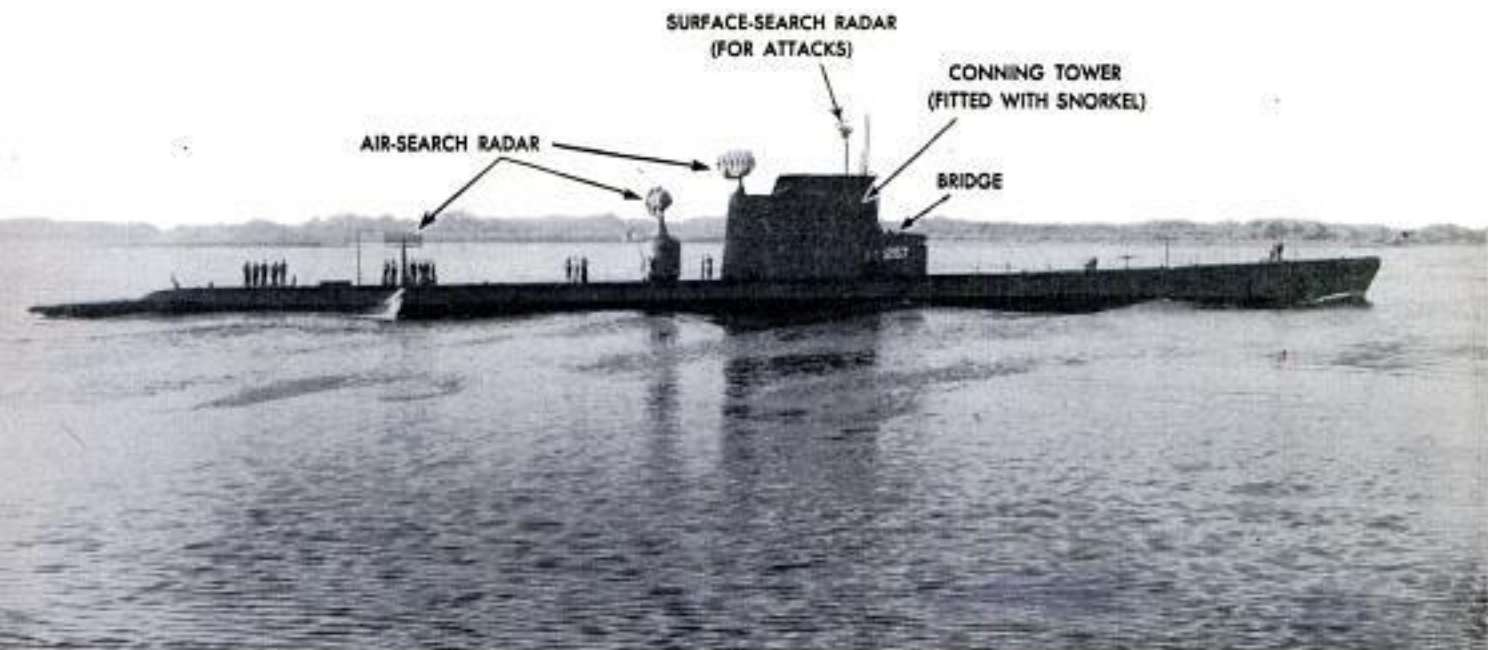

Radar picket is completely equipped to detect enemy planes and subs. Snorkel permits long undersea cruises

The SUB THAT CAN LICK A PLANE

By **Captain John S. McCain, Jr.**
U. S. Navy

CHARLIE, WE NEED submarines as radar pickets. Kamikaze planes nearly finished off our destroyer forces," said the weather-beaten little aviator who wore the three stars of a vice admiral, U.S. Navy.

"John Sidney, we're way ahead of you. They are on the way," answered Vice Admiral Charles A. Lockwood, commander of our submarine forces in the Pacific during World War II.

John Sidney's last name was McCain [the author's father]. He had just fought Task Force 38, the fast carrier spearhead, through the nightmare of the closing days of our assault on the Japanese Empire. He had seen his screening destroyers mangled by the suicide-bent pilots for lack of early warning.

This conversation took place aboard the submarine tender USS *Proteus* in Tokyo Bay shortly after the Japanese surrender in September 1945. Today we've got these radar pickets—five of them!

They are the *Requin*, *Burfish*, *Tigrone*, *Ray* and *Redfin*—all, as usual, named after fish. They're deadly boats but the sting isn't in the torpedo. They do their damage



Author McCain, right, confers with Comdr. J. W. Reed, division commander for the radar picket submarines

secretly and quietly with radar. They finger out approaching planes that might attack the giant task forces by surprise.

They are loaded with a large assortment of radars made to detect high and low-flying planes. The many antennas and reflectors give a strange appearance to submarines once built to carry only torpedoes. When seen from dead ahead they look something like a catfish with all his feelers rigged for action.

With its own air-control center, the submarine can vector in our own planes to attack. At the same time it has its feelers out to detect suspicious contacts that may be the forerunner of an enemy raid. In

addition, it "delouses" returning strikes. This is air-defense lingo for an operation in which the radar picket searches in the direction of returning planes to make sure that they are not being followed. In case enemy planes attempt to trail our planes, it sends in fighters to knock them down.

These five submarines, distinguished warriors from World War II, now serve in a new role. The USS *Ray* sent 48,000 tons of Japanese shipping to the bottom. After the war she spent four years in mothballs in a state of suspended animation. Her decks were silent; no longer did the raucous blare of the diving alarm call all hands to battle stations. Then action of an entirely different sort beckoned and she was towed to the Philadelphia Navy Yard.

Under the deft knife of the naval constructor she was cut in two while in dry-dock and the halves were pulled apart. A 30-foot section was inserted and welded into place. Instead of a length of 312 feet, she has grown to 342 feet. She now displaces 2200 tons, 400 tons more than before the operation.

The surgery performed on the *Ray* saved \$9,000,000 as compared to the cost of building a new submarine—further proof of the

wisdom of putting our ships in mothballs.

The new section contains the "air-control center" which does just what its name implies, controls the planes. Here information is received and evaluated for use in the direction of our own fighter planes. To do this requires radar repeaters, status boards, dead-reckoning tracers, remote-radio equipment and internal-communication systems. Air-search radar, height-finding radar and aircraft homing gear complete the picture. When all this equipment is in operation, the heat generated becomes a problem. Air conditioning is a must. Two 17-ton units run continuously.

The care and maintenance of the mass of tubes and electrical circuits requires high technical skill. The crew includes fifteen radiomen, radarmen and electronics technicians, not to mention the score of strikers under training. These men must be of the highest caliber because once the sub is at sea it is entirely self-sufficient. The conventional submarine has a crew of 70 men; this sub needs 85 men to accomplish its missions.

The Navy's thinking behind radar pickets is not very new or radical. Most weapons are basically modernized versions of ancient arms. For centuries armies used soldiers as pickets to forestall a surprise attack by the enemy. For the same reason the commander of a large task force would station destroyers far ahead of the fleet to give timely radar warning of enemy aircraft coming in to attack.

But, destroyers, it was clear, were not the

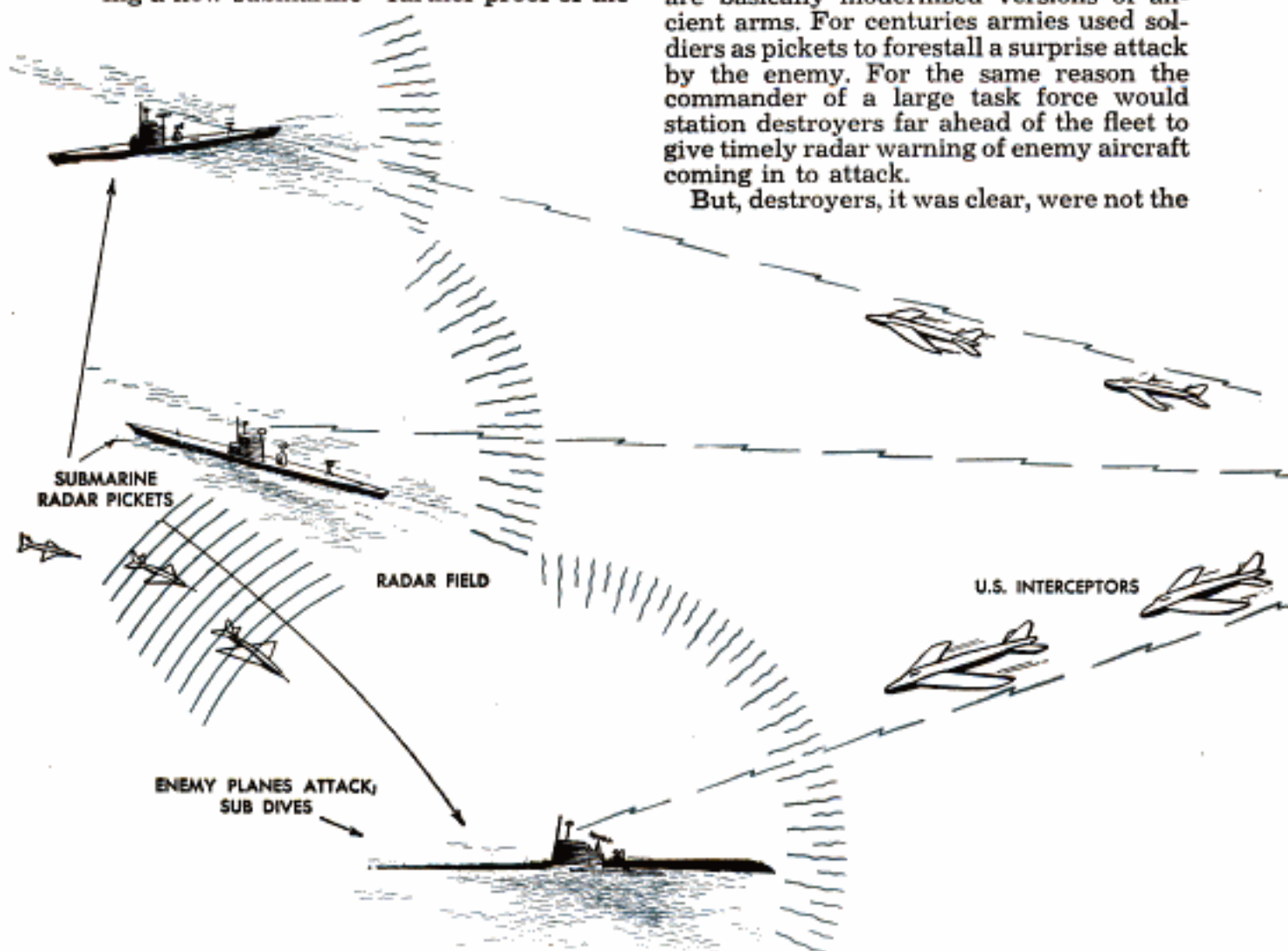

best vehicles for picketing in World War II. While serving as radar pickets during the closing days of the war our destroyers suffered terrific losses. In all, 134 of these ships were sunk or damaged with the loss of American bluejackets running into the thousands. Most of them were hit by Kamikaze planes off Okinawa. In this campaign 9,731 officers and men from all the ships of our Navy lost their lives. More, by far, lost their lives to suicide attacks than to any other cause. In fact, it got so bad that one destroyer in an effort to divert the Nip hung a large sign over the side. It consisted of a large arrow pointing aft and underneath in big letters were the words, "This way to the carriers."

On the 14th of April, 1943, the destroyer USS *Laffey* moved into Radar Picket Station 1, north of Okinawa. This put her in a position to detect Jap planes coming in from the Empire. The landings were in full swing and the Nip was fighting for his life. The 15th passed with a large number of contacts but nothing out of the ordinary. The 16th of April was a different story. In the space of 79 minutes the *Laffey* took a total of 22 Kamikaze attacks. Against those, she shot down nine planes. Seven hit the ship and five did extensive damage; the other knocked off a radar mast and one of the yardarms. Three officers and 30 men were killed.

The reason we picked submarines for the

Submarines in constant radio contact with carrier and escorts many miles away can detect enemy planes in time to warn task force, direct U.S. interceptors, then dive to a depth where they're immune from attack



CARRIER TASK FORCE
APPROACHING
ENEMY SHORES

MARCH 1954



Radio operators on radar-picket submarine monitor ship-plane-sub messages coordinating the attack



Evaluator in radar-picket sub directs U.S. planes to intercept enemy aircraft. Below, plotters spot positions of friendly and enemy planes on glass charts. Man at left is marking "TH" (target height)



job is simple. They're low in the water; they're hard to detect and can dive within seconds to a depth where they are relatively immune from prolonged aerial attack. Perhaps the best reason for the picket sub's existence is that it can detect the oncoming planes, send out a warning to the fast carriers hundreds of miles away and then submerge. The attacker is robbed of the element of surprise, nine-tenths of the battle, and can be met with force.

Radar pickets can be sent out days or weeks ahead of the time when a fast carrier force would move into an area for attacks. The attacks, unleashing tons of bombs, might be intended to weaken the enemy's position and destroy his war potential or they might be the preliminary to a gigantic invasion.

The picket skipper gets his sailing orders, is briefed by the admiral, boards his submarine and departs. Once clear of the channel and buttoned up for operation, he calls his officers to the wardroom for a conference on the coming mission. Up to this point they have been kept in the dark. The entire success of the strike depends upon secrecy.

With charts spread over the tiny wardroom table, the course to the point off the enemy coast is carefully checked and discussed from all angles, not the least of which is the possibility of detection by the enemy. Discovery of the submarine might

well ruin the entire effort in a dead giveaway. It's a cinch that the enemy will use his coastal fishing boats as lookouts. He will certainly have patrol planes out and there will always be the danger of discovery by his submarines. All these things must be considered and weighed. The depth of water as the sub gets closer to shore is another important item. A submarine in shallow water is no better off than a fish under the same circumstances. When is the moon going to be full? A full moon makes it dangerous for a submarine to surface at night. Although "D Day" will come at a time during the month when there is no moon, the sub arrives on station long before this.

Operation orders tell the skipper he must make 240 miles every 24 hours. This gives him a chance to proceed at snorkel depth, which lessens the chances of discovery by enemy antisubmarine forces. Also, he can drill at diving and other exercises and still have sufficient speed to regain position.

As the sub nears the coast, stealth and secrecy are paramount. The skipper spends all his waking hours on the bridge when on the surface, and in the control room when submerged. He sleeps on a catch-as-catch-can basis, always with "one eye open." The captain of a submarine is in a position somewhat different from that of commanding officers of other ships. He is

(Continued to page 228)

USS Ray was sliced in half and 30-foot center section added to convert it to picket sub. New length is 342 feet

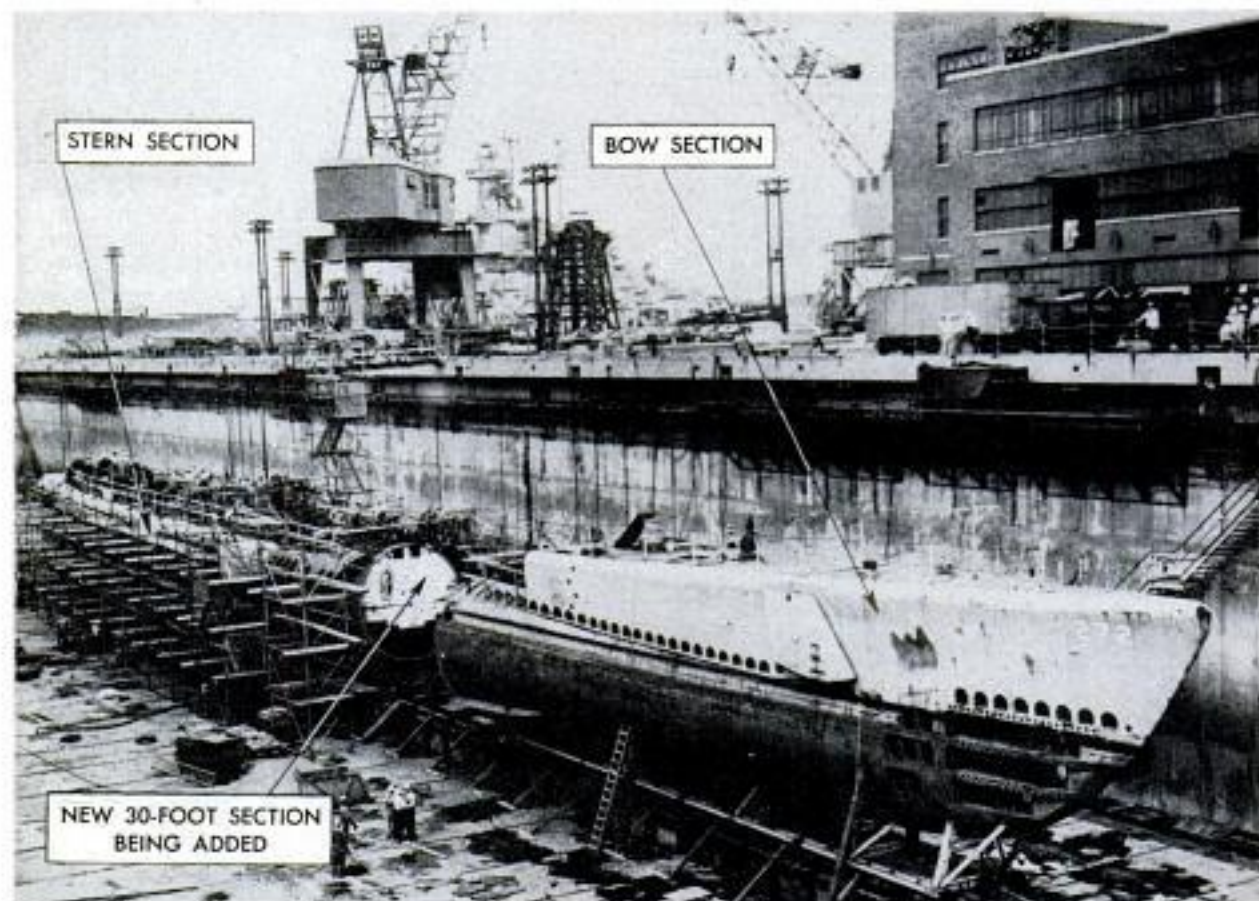

Machine "Plays Records" To Sew Desired Stitches

Imported from Switzerland, a new portable sewing machine "plays" plastic disks to produce almost any desired variety of stitch. The disks, slightly larger than a half dollar, are inserted into the top of the machine, and without further attachments the machine produces the recorded stitch. The machine sews straight and zigzag stitches; it sews on buttons and knitted fabric; it makes button-holes, blind stitches, monograms and scores of ornamental stitches. The number of designs is limited only by the number of disks, and more than 100 disks are now available with others planned for the future. The carrying case of the machine opens out into a full-size worktable. It includes an accessory box in which the home sewer can store a supply of thread, needles and other accessories. A "free arm" on the machine enables the seamstress to sew or mend socks, sleeves, trousers and anything else of a tubular nature. A twin needle clamp permits her to use two needles with different threads at the same time. A calibrated control adjusts the bobbin tension to the thickness of the fabric. The machine has a built-in knee control. Also available is a lower-priced model of the machine which does not have the plastic-disk mechanism, but is so designed that this feature can be added at any time in the future.



Dye Sprayed From Pressure Can Finds Flaws in Metal



Dye sprayed from a pressure-type can is drawn into cracks or pores to show up flaws in metal. A kit containing the dye and other chemicals is used to detect faults in weldings, castings, tools and machined parts. The dye is sprayed on the surface to be tested. This is followed by a spray-on cleaner, which is removed by wiping. An even coat of white developer then is brushed on and the spot is inspected. Cracks show up as bright red lines and pores or leaks are indicated by red spots.

If you do not find the information you need in the WHERE-TO-BUY-IT INDEX, starting on page 12, sources of further information are available without charge from Bureau of Information, *Popular Mechanics Magazine*, 200 E. Ontario St., Chicago 11

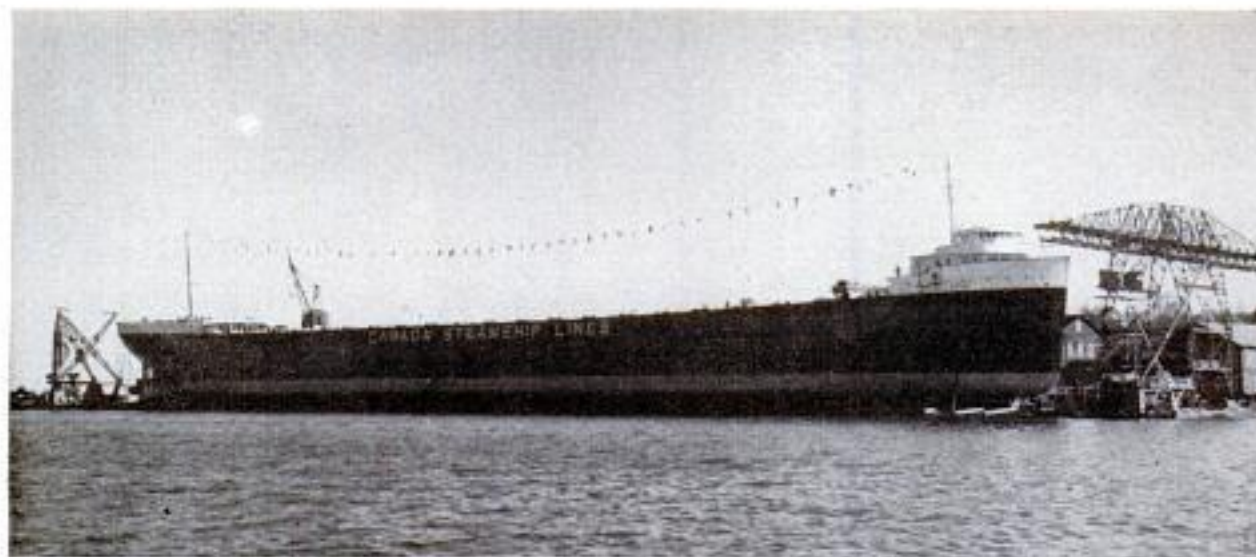

Biggest Great Lakes Freighter Completed in Record Time

Only 41 weeks passed between keel-laying and launching of the 715-foot *T. R. McLagan*, said to be the world's largest inland-lake freighter. If the Canadian vessel had been any longer, it could not have traversed

the locks between lakes. The \$6,000,000 ship burns fuel oil and is powered by a steam turbine supplied from two water-tube boilers. It will exhaust through a single stack 80 feet high and 65 feet around.

Self-Loading Truck Picks Up Huge Logs

Speedy salvage of beetle-infested timber in Oregon forests is the function of a self-loading logging truck. A typical model built by logger-mechanic Roy Menteer starts with a 105-horsepower truck. Menteer rebuilds the frame, lengthening it to 26½ feet and reinforcing it for ponderous loads. A chain-drive rear end is installed. Behind

the cab are mounted a 10-foot steel A-frame and a 15-ton winch. A power take-off on the transmission case drives the loading line. Built into the boom is a manually operated hydraulic jack for use when extra clearance is needed. Two men handle the rig; the only other logging equipment needed is a pickup truck and a power saw.





Playing "radio bingo" in Denver VA hospital. Headset outlet on wall has a pull cord for program changes

More than 125,000 veterans have a direct pipe line to sports, music, fun and education on Uncle Sam's

Bedside Radio Network

By William Harnin

Patient-announcer beams a "taped show" to buddies

MORE THAN 125,000 listeners a day—every one a hospitalized ex-GI! That's the exclusive clientele of the Bedside Radio Network, comprising 165 stations at Veterans Administration hospitals in every state and Puerto Rico. These broadcasting units are pioneering a new teamwork concept in the hospital field: therapy by radio.

The Bedside Network broadcasts exclusively within each hospital area to Uncle Sam's sick and wounded veterans. With the exception of VA recreation personnel assigned to supervise the stations, the unique sickroom radio chain is staffed almost wholly by patients.

In the main control room of each hospital are FM and AM receivers tuned to outside radio programs. The programs are amplified and channeled directly to the wards. Patients have their choice of three to five different shows. Volume control, tone control and outside station selections are adjusted at the master console in the hospital studio. All VA radio stations boast modern equipment, most of which experiences

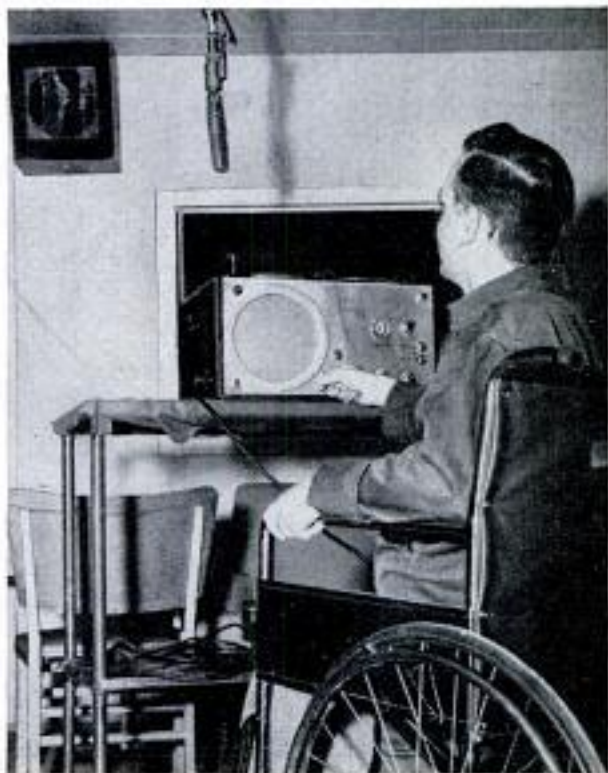



Monitoring a newscast originating at the hospital, Gene Boone of KDVA has grade-A equipment to work with

Portable units, like this remote-transmitter cart with a player for 16½-inch records, make the bedside broadcasts possible. Sports and music rate high as entertainment fare with most convalescents



very hard use in maintaining a 14-to-16 hour daily broadcast schedule.

The network depends extensively upon Armed Forces Radio Service 16½-inch transcriptions supplied to hospitals by the Armed Forces Information and Education Division. These records provide the variety of musical shows, stage entertainments, and dramas so familiar to World War II and Korean veterans. Additional use is made of standard 78, 45 and 33½ r.p.m. recordings.

Upkeep of the complex wiring, audio-system amplifiers and control console falls upon each VA hospital's engineering officer. Routine monthly inspections and repairs of all bedside headsets, selector switches, ward loudspeakers and amplifiers in the main control room are conducted by electrical experts.

Although no station in the VA network may broadcast outside the hospital area (the units operate independently and cannot be linked for a nationwide simultaneous broad-



Listening devices can be provided to meet any patient's particular need. Bed patient wears conventional headset and man in center holds a plastic pillow speaker. Stethoscope headset, right, has special volume control

cast) each station prides itself on its call letters. At Fort Wayne, Ind., WFWI does an outstanding job in providing radio entertainment. At Castle Point, N. Y., it's WRBS; at Lyons, N. J., KOLH and, at Cheyenne, Wyo., Station KCVA. Organization of the Veterans Administration's vast chain of Special Services radio outlets began early in 1946.

Radio is important in Veterans Administration hospitals because it is a major link between the isolated patient and the outside world. That's why it is necessary to analyze all programs, selecting only those which satisfy the special requirements of the men. This difficult assignment is handled by hospital recreation, a part of the special-services division.

Usually, convalescent veterans will not listen to soap operas, commercials or "agony" dramas. Instead they demand—and get—sportscasts, good music, news and special medical shows which tell them about their particular medical problems.

Patients interested in announcing, script writing and bedside disk-jockey chores are trained and given assignments. Prior medical clearance by physicians, however, is mandatory. Consideration must be given to the physical limitations of each patient.

Numerous unusual programs have been developed. At Cheyenne, bedridden paralytics play checkers on numbered checker-

boards. The men use hospital "mikes" at the bedside to indicate their moves. In some hospitals the vets play "radio bingo."

At Castle Point, N. Y., a group of patients called "The Strivers" presents 48 live radio programs weekly. The Mask and Wig Club of Marion, Ind., performs a similar function, while Walla Walla, Wash., veterans forget their own discomfort by transcribing disks for students at the Vancouver School for the Blind.

Wardcasts, programs which emanate directly from bedsides, are popular with all VA patients. In reality, the wardcast is a remote-type broadcast channelized through the central multichannel set-up. Such programs include radio bingo and disk-jockey shows.

Patients record some "taped" shows exclusively for bedside listening. Subsequently, the tapes are circulated to other VA hospitals throughout the country. Featured performers, including Stan Kenton, Jimmie Durante and Burl Ives, have taped 15-minute and half-hour entertainments in many VA radio rooms.

The "Tape Recorder Network" of 80 member hospitals—a network within a network—is divided into eight separate operating divisions. Thus hospitals on each circuit (the tapes are shipped by mail) can share their best taped shows with each other. Naturally, the patient benefits! ★★ ★

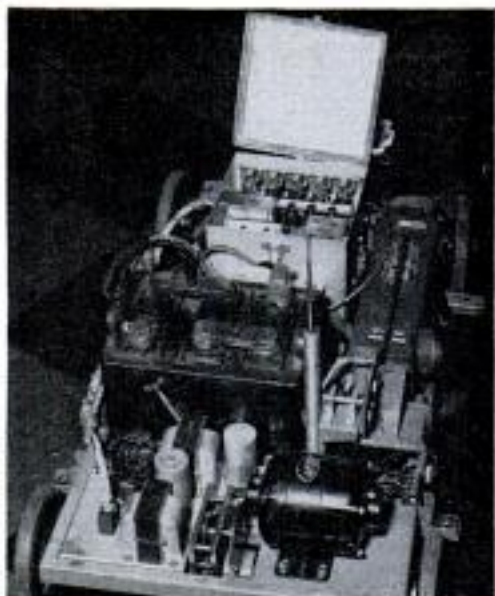
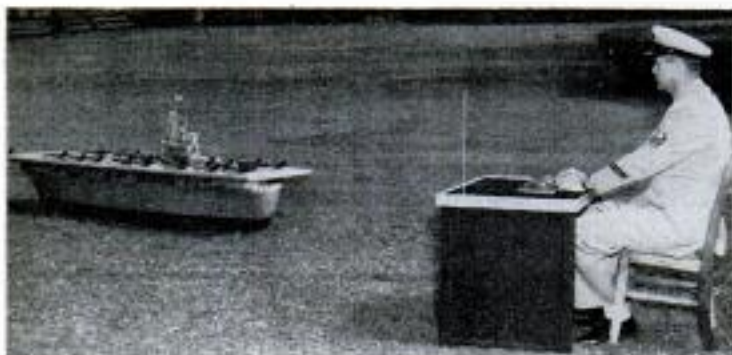

Model Navy Panther jets ride the plywood flight deck, upper left, of the rubber-tired carrier. Speaker is hidden under airplane elevator in bow of carrier's flight deck

With hull and deck removed, above, carrier chassis is a compact maze of batteries, motors, receiving equipment and the drive mechanism. The motor is in the foreground

Operating carrier model, left, is a simple matter of moving two double-acting toggle switches for desired direction. A third switch cuts in the communications system

Carrier Model Rides Landlocked Course on Scooter Wheels

Riding on rubber-tired scooter wheels instead of waves, a *Midway* class carrier model operates in a half-mile-wide "sea" at the Naval Gun Factory, Washington, D. C. Christened the USS *BuShips*, the crewless, landlocked craft was made from scrapped plywood and junked electronic equipment. It is 9½ feet long and weighs 122 pounds. An FM transmitter, operating on ordinary house current, gives the oper-

ator full control of the ship's movements within a half-mile range. The carrier's driving power comes from an automobile battery that can propel it at top speed of five knots. One battery charge runs it for four hours. A small electric motor that once raised and lowered the convertible top of a wrecked Mercury now steers the craft's nose wheel, which was formerly part of a hospital bed.

Pipe Clamp Tightens to Form Seal Around Leaks and Connections



Leaks in water, oil and steam pipes are stopped with a two-piece fitting that clamps around the pipe. Four screws are tightened to contract a Neoprene gasket and form a gastight, watertight seal on each side of the leak. The clamp can also be used to assemble temporary or emergency lines without threading the pipe units. Two models are manufactured: A bell type to repair leaks at joints, and a cylindrical type for leaks in the pipe itself.

Information not listed on articles in the index frequently is listed in the WHERE-TO-FIND-IT LIST, free to readers from the Bureau of Information, *Popular Mechanics*, 200 East Ontario St., Chicago 11

NACA has experimented with designs like this wing-tip ramjet with horizontal control surfaces in the nose of ship



THE SHAPE OF TOMORROW'S PLANES

By Thomas E. Stimson, Jr.

BEHIND THE CLOSED DOORS of America's aircraft factories a battle of wits and wind tunnels is under way to decide the shape of tomorrow's high-speed airplanes.

"A thin, straight wing is okay," one engineer muses, "but where will we stow the fuel and landing gear? Can't pull a trailer behind the plane. We'll use a delta wing that has lots of room inside."

Grouped around the needle-nosed Douglas X-3 research aircraft, are types including straight wing, delta and swept-back wing model



Copyrighted material

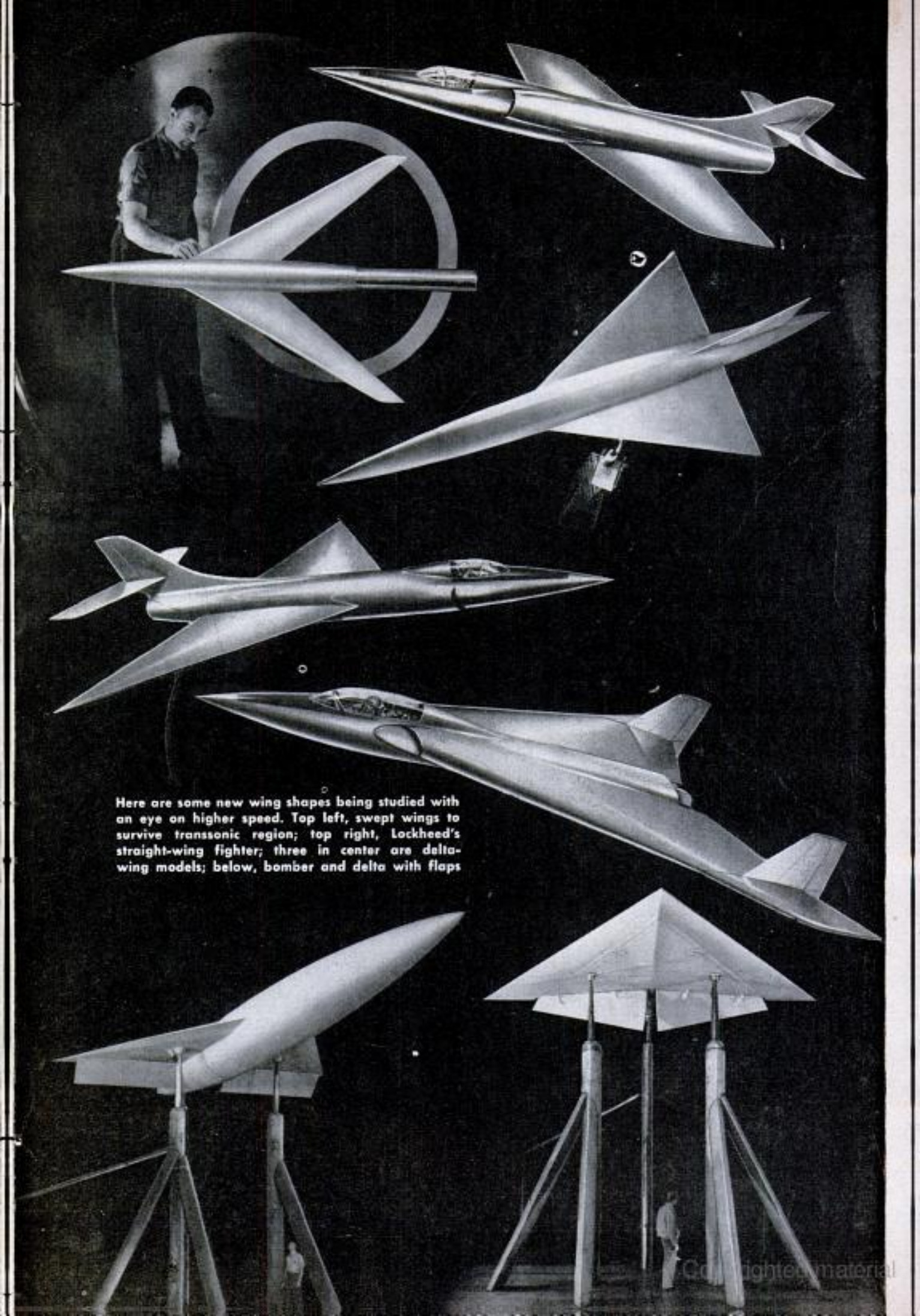

Here are some new wing shapes being studied with an eye on higher speed. Top left, swept wings to survive transsonic region; top right, Lockheed's straight-wing fighter; three in center are delta-wing models; below, bomber and delta with flaps

"Trouble with the delta is its high landing speed," another decides. "We'd need to increase the size of the wing to get the landing speed down, and that increases the drag. A swept-back wing looks better."

And a third engineer, weighing the merits of all the shapes, concludes that a straight wing can't be beaten after all.

The result is that aircraft are taking on a variety of planforms never seen before. The Germans pioneered the swept-back wing design during the last war and made studies of the delta shape as well, but little else was done until about six years ago when North American tested its swept-wing F-86 and Boeing wheeled out its swept-wing B-47 bomber. At about the same time Consolidated Vultee was completing its XF-92A, a research plane with a triangular delta wing. This wing proved so successful that Convair has since flown two other high-speed delta aircraft, the F-102 and the XF2Y-1 Sea-Dart which is a water-based plane.

Official records don't yet suggest that any one shape is outstanding. In 1948, a swept-wing plane took the world speed record away from a straight-wing type, then last year one American and two British swept-wings each set new speed records in a row. Weeks later the Douglas F4D Skyray, a modified delta, captured the record at 753 miles per hour. Shortly afterward, a new North American swept-wing Super Sabre, our first supersonic combat plane, flew in excess of 754 miles per hour.

The competition hasn't ended and there's every chance that the delta F-102 will fly fastest of all when tested, possibly this year. And it might be that Lockheed's new straight-wing F-104 "air superiority" fighter will return the speed record to that type when it flies.

The 1327-miles-per-hour speed of the Skyrocket and the more than 1600-miles-per-hour speed of the



First U.S. delta-wing aircraft was a Convair XF-92A



Above, a Convair Sea-Dart, first delta wing water-based fighter, uses hydro skis. Below, Douglas XF4D-1 Skyray held short-lived record of 753 miles per hour



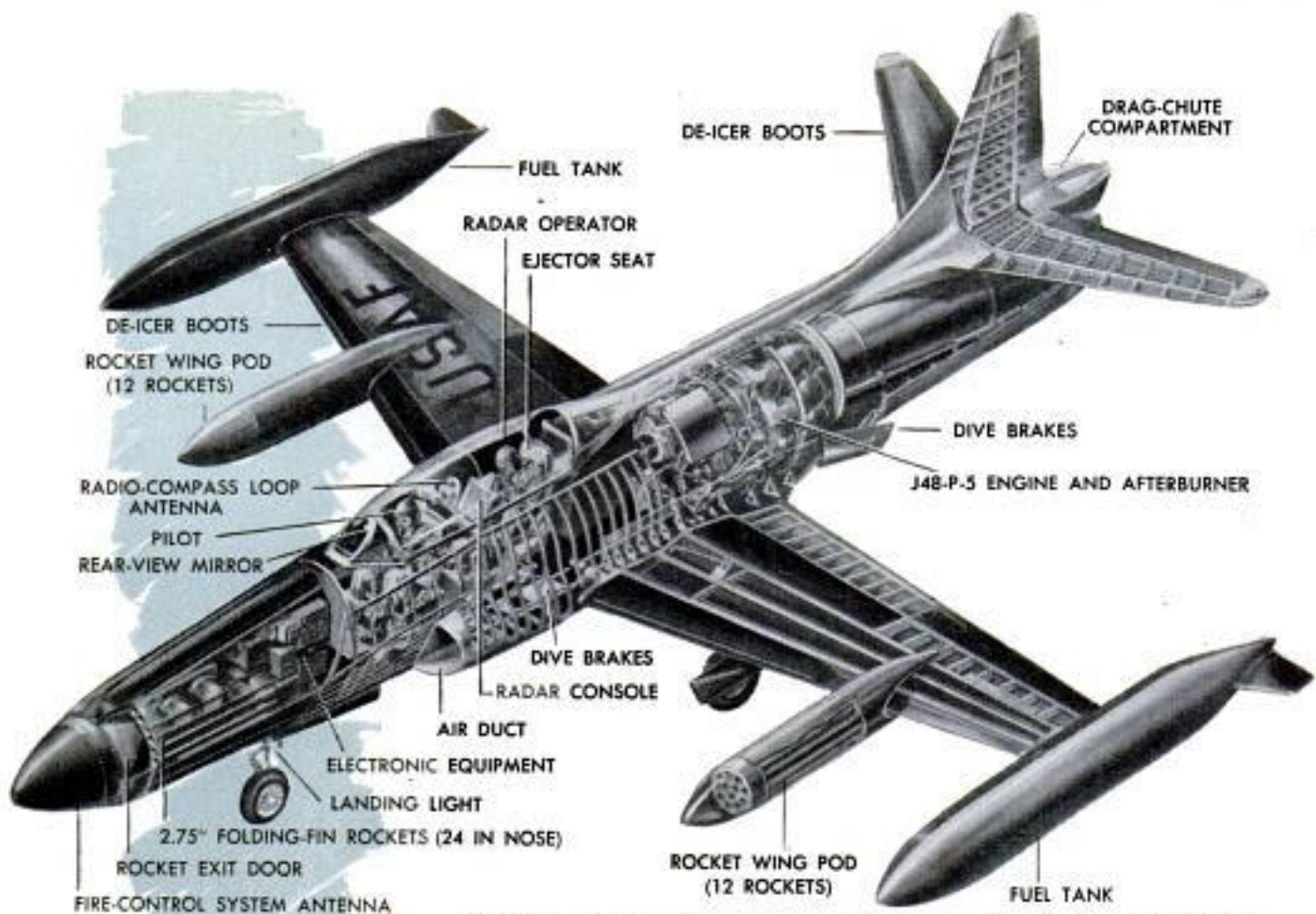

Cutaway above is of the Lockheed Starfire, a 600-miles-per-hour aircraft

from the end of the new runway. The combination of the two dry lake beds and the connecting clearway will provide 22 miles of straight-line landing area.

The control tower at Edwards is 140 feet tall. Men with field glasses and radio mikes can direct traffic on a runway that is a mile away. When the occasion demands, they can control take-offs and landings five or six miles away on Rogers Dry Lake.

In addition to flight testing both fast and heavy planes, Edwards is the home of the Air Force Experimental Test Pilots School.

Below, models of various straight, tapered, swept and delta-wing shapes tested recently at supersonic speeds in wind tunnels at research labs



LOCKHEED STARFIRE



DOUGLAS SKYROCKET



DOUGLAS SKYRAY



CONVAIR SEA-DART

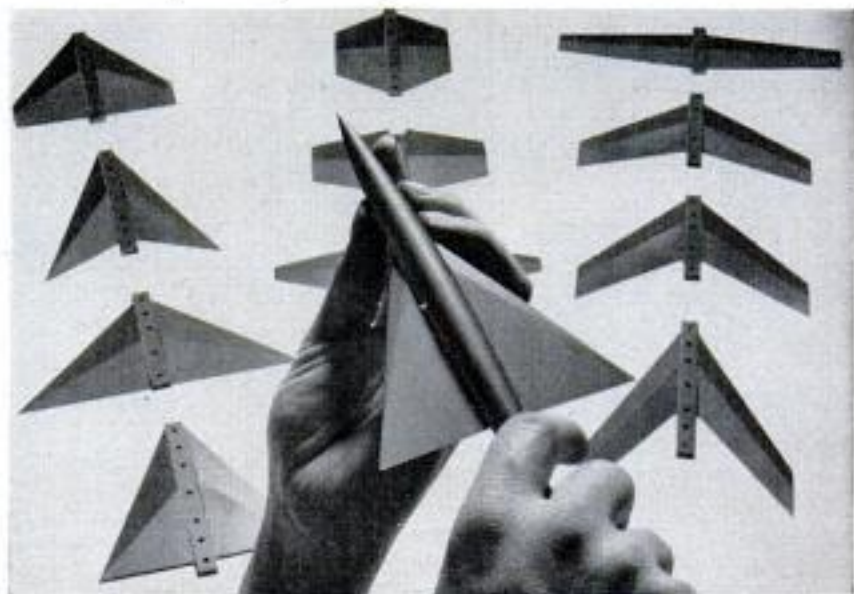

In the field of large aircraft, a search is also going on for the fastest and most efficient wing shape. Boeing and Douglas both have done research on jet passenger liners designed to travel at 550 miles per hour, and each design has a swept wing. But in England the Avro Vulcan bomber in the same speed range has a delta wing. It is literally a flying triangle with fuselage attached. Avro plans a big transoceanic passenger liner with the same wing shape.

The fact is, says the National Advisory Committee for Aeronautics, that many other things beside top speed alone help to determine the planform of any particular aircraft. The desired cruising speed, desired range, structural weight, available power and permissible landing speed, plus the way that the engineers decide to build these characteristics into one package, all help determine the final shape. Power is always more important than wing shape alone for high speed.

In its wind tunnels near San Francisco the NACA has tested nearly every conceivable shape that an airfoil might take. For one "mission" alone the research staff made wind tunnel runs on 20 different wing shapes ranging from straight to swept to delta, then turned their findings over to the manufacturer for final choice. NACA makes no recommendations, it merely reports its findings.

Briefly, comparisons of the different wing shapes are summed up this way:

Strength. Delta is structurally the soundest and permits the design of a thin wing weighing less than the other shapes.

Take Off and Landing. Here the straight wing excels because it requires the shortest runs. Swept-wings and particularly deltas develop their lift at high angles of attack and they take off and land in a "flared" nose-high attitude. Pilot's cockpit must be moved farther forward in the nose to insure good visibility in this position.

Maneuverability and Stability. Stability of the delta doesn't change much in its entire speed range, as does a straight-wing, yet it tends to yaw and pitch and requires damping controls. Swept-wings with tails probably maneuver more easily.

High Speed. Swept-back and delta wings delay the compressibility effect and go through sound without the enormous increase in drag that occurs to a straight wing. Swept and deltas may be best at Mach 1, the speed of sound, though

Ramjet engines mounted on the wing tips of a Lockheed F-80 Shooting Star spurt flames on test flight. The tubes are 20 inches in diameter



MARCH 1954



CONVAIR F-102



CONVAIR F-92A



NORTH AMERICAN F-100



NORTH AMERICAN F-86



BOEING B-52



DOUGLAS X-3



DOUGLAS SKYSTREAK



NORTHROP X-4



Boeing B-47 Stratojet with JATO equipment sears the earth at Edwards Air Force Base, Calif., in take-off



a tapered straight wing may prove best at Mach 2. However, the delta has become a conventional shape for the control surfaces of missiles that fly much faster than Mach 1.

The general conclusion is that the delta has a slight edge over the swept wing and a bigger edge over the straight wing for achieving supersonic speed with a given power plant. Actually the merits of each planform will be decided only by flight testing and that is the stage that is occurring now.

Aircraft engineers expect that it will be a number of years yet before planes are flying at supersonic speeds, except for a few research craft. It's true that several fighter planes can travel faster than the speed of sound, especially in dives, but these short bursts of speed are beyond the normal operating speeds of the aircraft. Today's fastest production aircraft are considered to be of the transsonic instead of supersonic type. The region of supersonic speed begins at 800 or 850 miles per hour.

Looking into the future, the engineers agree that it is going to take much more than an advanced wing and a big power plant to achieve supersonic speeds. The big problem is to prevent the aircraft from literally burning up while flying fast. Better wings, better engines and some way of rolling back the thermal barrier

(Continued to page 248)

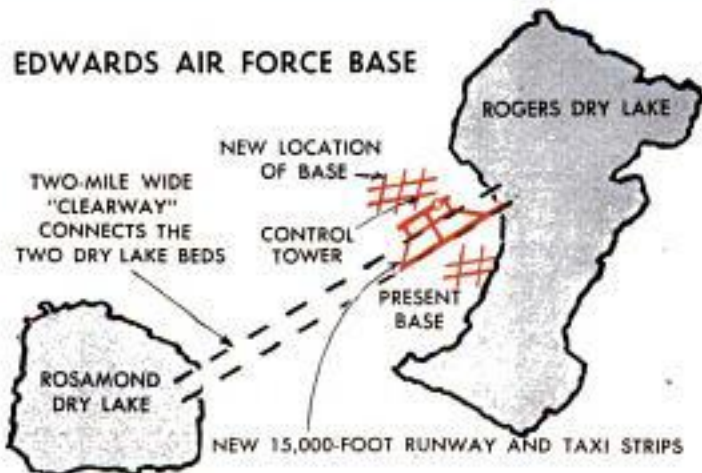

The 140-foot control tower at left is midway of main runway at Edwards which connects two dry-lake beds to provide 22 miles of straight-line landing area at this 200,000-acre Air Force flight-test center. Rosamond Dry Lake is an emergency landing area for pilots

Heartbeats and Brain Waves Telephoned to Distant Specialists

Rural doctors can soon obtain the diagnostic services of heart and brain specialists located 3000 miles away. The patient's electrocardiograph signals or brain waves are amplified, changed from AM energy to FM tones and then transmitted over telephone lines to a specialist in a distant city. Receiving equipment enables him to analyze the patient's heart condition or brain waves immediately, or to store the data on magnetic tape. In the case of a heart patient, the specialist receives an electrocardiogram. Brain waves, which may indicate cerebral hemorrhages or brain tumors, can be heard, traced on paper and made visible on a cathode-ray tube. The method and equipment were developed at the University of Nebraska.

Amplified brain waves of patient, right, are converted to an FM signal and sent by long-distance telephone to consultant



Electronic Nutcracker Severs Walnut Halves Without Damage

Powerful surges of electrical current crack walnuts in an Oregon plant. Two metal electrodes grasp each nut as it tumbles from a threaded feeder roll. A 65,000-

volt jolt passes between the electrodes, splitting the nut into undamaged halves. Following this, a vibrator conveyor severs the nutmeat from the shells.

Plants Raised in Radioactive Atmosphere Aid Tracer Studies

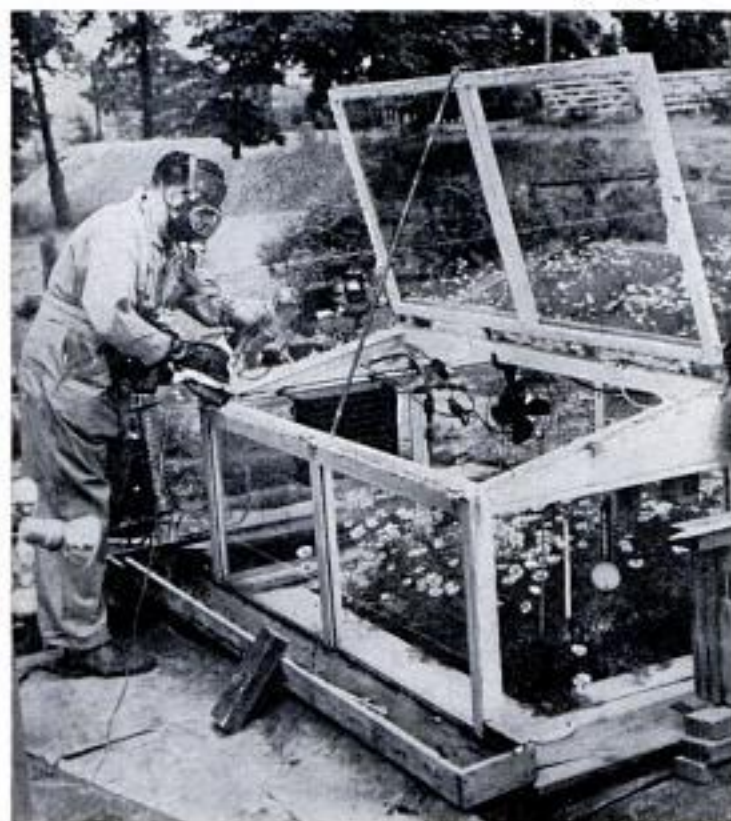

Rubber gloves, disposable clothing and a gas mask are standard garb when picking radioactive flowers at Gulf Oil Laboratories. The plants — pyrethrum flowers used in household insecticides — are raised in a dangerous atmosphere of radioactive gas for 56 days. The "hot" plant extract produced is traced to discover how pyrethrum kills flies, cockroaches and other insects.

Curved Meteor Film

Film curved in the shape of a bowl fits into a highly efficient meteor camera developed by Kodak for Harvard astronomers. The curved field is designed to provide the fastest possible speed. Operating on the same sky region as one of the earlier meteor cameras, the new camera photographed 56 meteors. In the same period, the older instrument could photograph only one meteor.

Electric Switch Mats Placed Under Rugs Set Off Burglar Alarm

Intruders are detected by wide, thin electric switch mats that can be placed under rugs or carpets at strategic locations within a house. One suggested place is in front of the most easily accessible door in the house, which will usually be unlocked by a burglar to insure himself a means of quick exit in case of discovery. The mat or mats are connected by a single pair of wires to a control box in the bedroom and the slightest pressure on any mat causes a buzzer to sound there, warning the householder. An attachment for additional protection, intended to scare away burglars, causes a bell to ring loudly when a mat is touched and to continue ringing until turned off. Any number of switch mats can be used with a single control box and additional ones can be added even after the system is installed. The connector can be plugged into any 110-volt outlet.

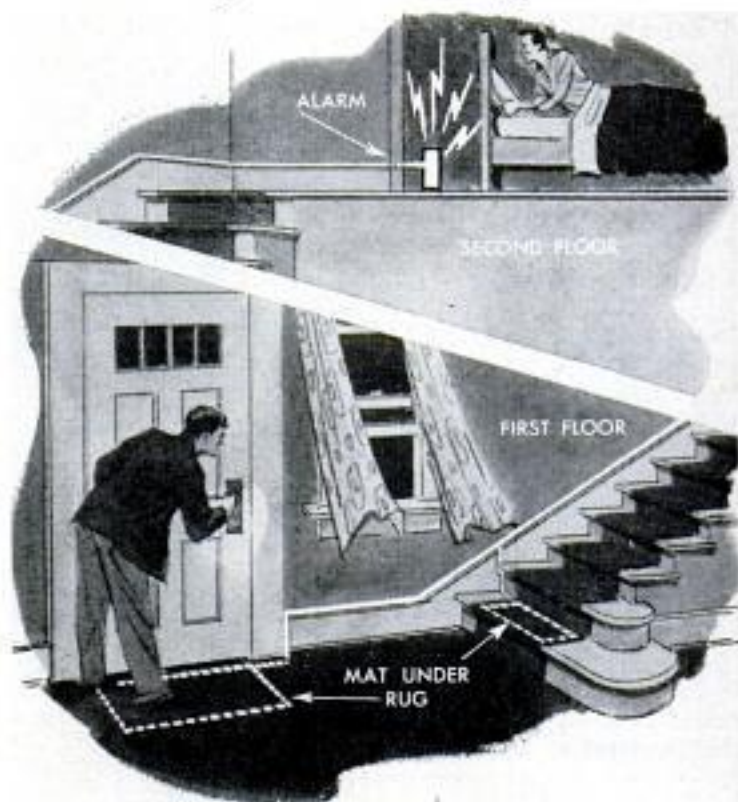

Plastic Drain Unit Features Trap That Unscrews Without Tools

No tools are needed to remove and replace the trap in a new polyethylene drain unit. A plugged trap can be taken off and cleaned in seconds. A few turns of the trap reseals it; no washers are necessary. The all-plastic unit is unaffected by acids and other corrosive materials, is germproof,

frostproof, and its surface is nonadherent. Designed especially for chemical and hospital laboratories, it consists of a stopper, high-level drain, strainer, lock-nut, plug, trap and outlet union. The unit can be installed in any laboratory or factory sink as well as home plumbing systems.

Willys Aero Jeep Matches Speed and Light Weight of "Mighty Mite"

Willys newest version of its famed war-time Jeep is a midget vehicle three feet shorter and 1200 pounds lighter, faster and more agile than its older brother. Like the Marine's Mighty Mite (*Popular Mechanics*,

May 1953), which it closely resembles, the little Jeep is designed for transport by helicopter or plane.

It is 100 inches long, 60 inches wide and 65 inches high. A 60-horsepower engine pushes it to 72 miles per hour. It can carry four men or a 500-pound cargo across the country, or 1000 pounds over highways. A nine-gallon gas tank gives it a cruising range of 239 miles.

The big weight saving in the 1475-pound Jeep is due to its aluminum and magnesium construction — the all-aluminum body weighs only 81 pounds, the magnesium wheels total 41 pounds. But 85 percent of its parts can be interchanged with those of a standard Jeep. Both Army and Marines are testing it.



←Aero Jeep, although three feet shorter than older Jeep, can also carry four men



Air Research and Development Command photo

Air Force Uses 10,000,000 Candlepower Light for Night Photos

Light of nearly 10,000,000 candlepower is put out by a new device aiding low-altitude, high-speed aerial night photography. Contained in a 12-foot cylinder attached beneath the airplane's wing, the mechanism burns finely pulverized magnesium powder to provide the brilliant light for four minutes. It can be turned on and off by the pilot

and jettisoned if necessary. Built-in warning signals indicate anything wrong. The powder burns at an extremely high temperature and must be handled with care. Called the "Hell Roarer" because of the roar emitted when in operation, it was developed for the Air Force by scientists at Wesleyan University.

Heavy Webbing Muzzles Bombers During Pressurization Tests

Nylon muzzles now prevent Uncle Sam's big bombers from getting "vicious" during pressurization tests. Pulled over the nose and canopy, the socklike protector prevents a defective door or window from popping out and injuring test personnel when internal pressures are run up to more than

six pounds per square inch. It is made of nylon parachute-strap webbing. Its originator, Joe B. Gabriel, at Lockheed Aircraft's Marietta, Ga., plant got the idea while hiking up his socks. The muzzle replaces a cumbersome, steel bird-cage device and saves \$26 on every test run.

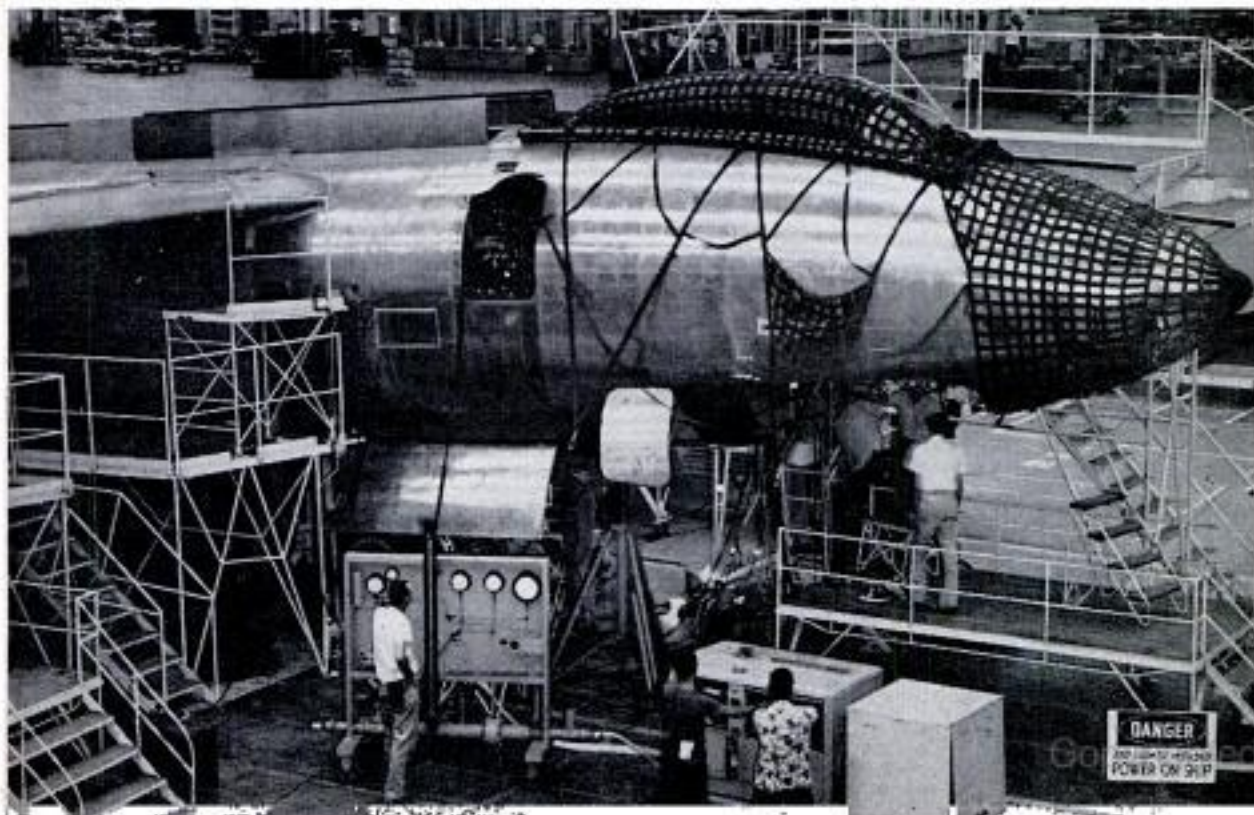

WHAT'S NEW FOR Your Home



1. ELECTRIC COOKER serves as a deep fryer or general-purpose cooker, sits on the table. It bakes, steams, warms or deep-fries food and pops corn. The heat control can be set for a variety of temperatures. A light indicates when the proper temperature is reached. Glass lid allows you to see what's cooking

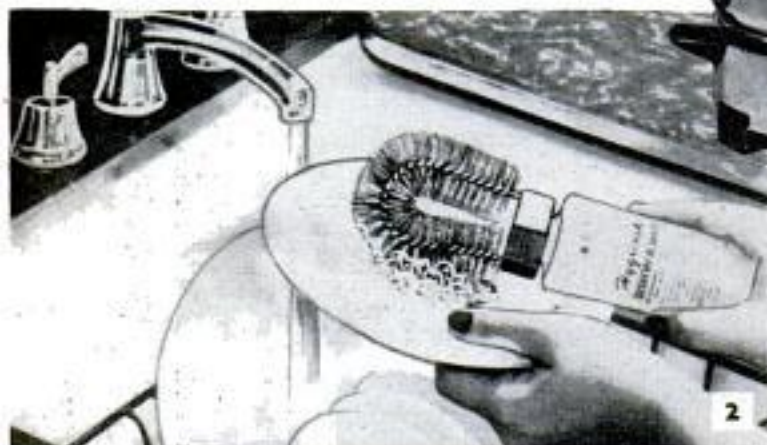

2. LOADED BRUSH dispenses aerated detergent suds at a squeeze of the flexible plastic handle. Brush head unscrews to permit filling of container with detergent and water. Suited to washing dishes, the brush can also be used to clean windows, rugs, woodwork and upholstery. Bristles are long-wearing

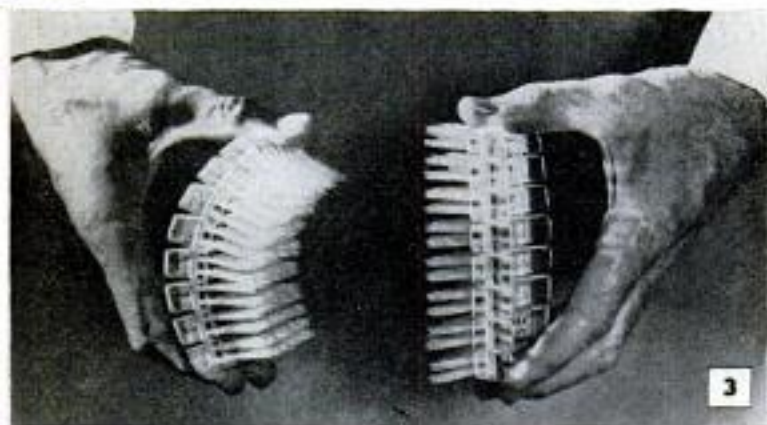

3. HAIR BRUSH bends to conform to head contour. The Lucite back, made in sections and held together with nylon rods, flexes so that all the bristles contact the scalp with every stroke. More effective stimulation of the scalp results, and the "plastered down" appearance of ordinary brushing is eliminated

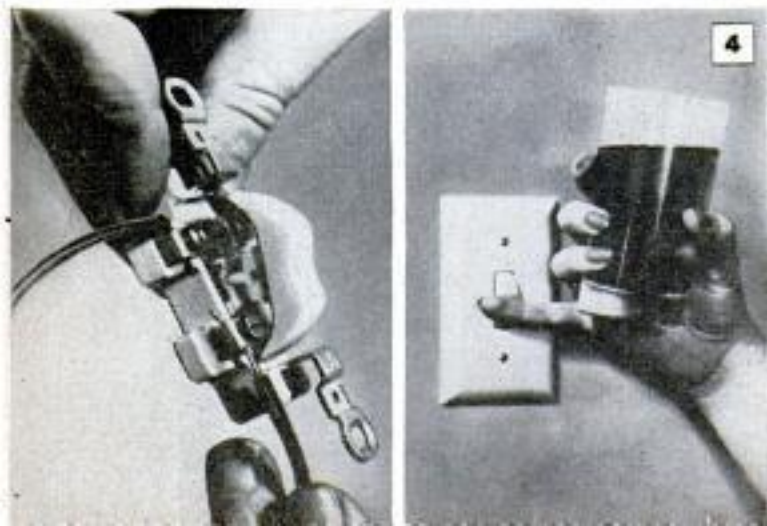

4. SILENT SWITCH snaps on or off at the touch of a finger and features an easy, sure method of making the connection. Instead of twisting the wires around the screws, you slip the wire's end under a flat contact plate. Tightening the screw brings the plate down in flat, positive contact with the wire

5. TIMER turns electrical appliances on and off at the same times daily without being reset. The unit has an "on" range of ½ hour to 23 hours and an "off" range of 1 hour to 23½ hours. Thus it can be used to cook a meal or defrost a refrigerator. A manual shut-off does not interfere with the setting



6. CUTLERY TRAY made of pliable plastic holds a variety of odd-shaped kitchen tools, is unbreakable and washable, lasts indefinitely. Cutlery can't harm the pliable material, which is noiseless and won't scrape table surfaces. The 12-by-16-inch tray fits any standard drawer, is available in red or yellow

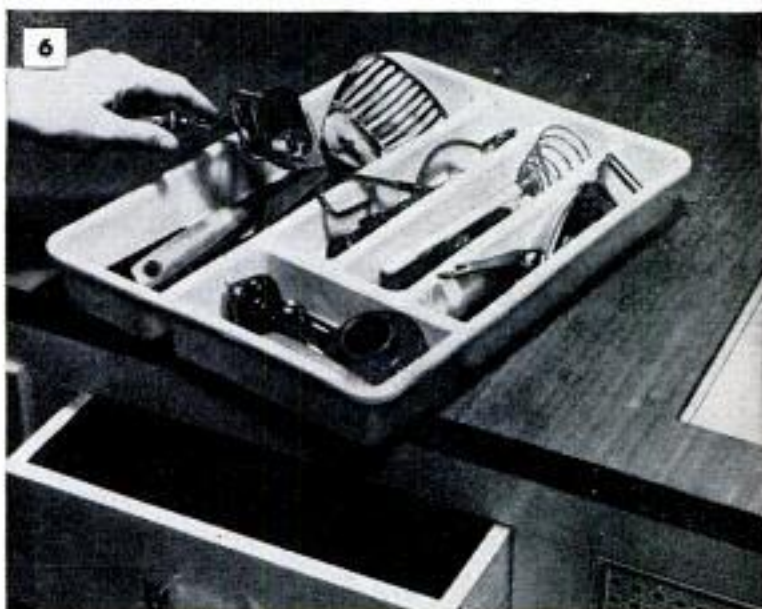

7. SHELF SUPPORTS allow you to build your own shelves without tools, nails or screws. Supporting brackets rest against the wall on top of existing shelves. A tab on either end of each bracket fits between the wall and the end of the shelf board, locking it tightly in place. Length is eight inches

8. REVOLVING SHOE RACK makes it unnecessary for you to grope around the floor of your bedroom closet for shoes. Wire rack which fits in the bottom of closet holds six pairs of footgear. A touch of the finger whirls the desired pair into easy reach. Rack is 19 inches in diameter and 10 inches high

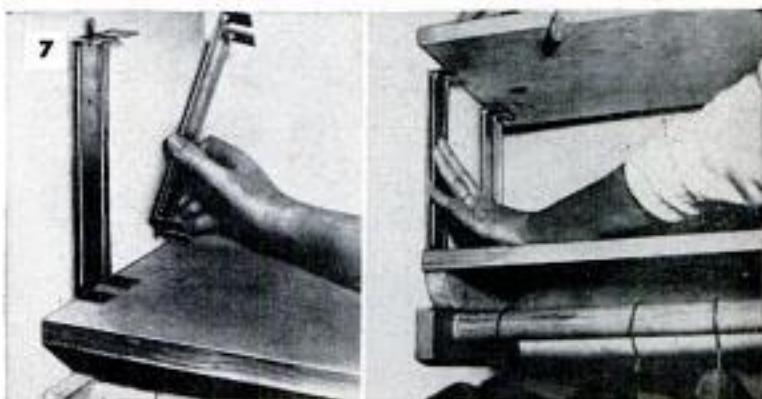

9. GUARD RAILS for medicine cabinets keep jars and bottles from tumbling out when you open the door. Clipped into place on existing shelves of glass or wood, they are installed without the use of tools. A combined rail and suspension bracket holds razors and shaving brushes within reach but out of the way





Quartered Skyscraper Suspended From Fins

Four hollow concrete fins rising 18 stories and intersecting in a cross support the weight of an office-apartment building in Bartlesville, Okla. Each floor is carried like a tray by the four arm-walls. Designed by Frank Lloyd Wright, the quartered building makes extensive use of cantilevers and lightweight aggregates. The hollow fins and floors accommodate the plumbing system, the automatic elevators and the air-conditioning ducts. Gold-tinted glass and 20-inch fixed copper vanes will cut the sun's glare—only indirect sunlight will be admitted. A 30-foot tower spire will provide television reception when the building is completed late in 1954.

Plywood Chair on Wheels Aids Crippled Children

Crippled children are moved about easily in a homemade plywood chair equipped with rubber-tired wheels. A removable play table provides space for food as well as books, coloring materials and other play articles. Under the seat is a large toy-storage section. The chair's inventor, Harry P. Speer, of Cedar Rapids, Iowa, has a son and three grandchildren who were victims of polio.



Electric Massage Chair Lessens Body Fatigue

Tired truck drivers and weary shoppers get a health treatment for a quarter from a coin-operated massage chair. The gentle, pulsating action of the vibrating back, seat and footrest unkinks sore muscles and aching backs and aids foot comfort. Some units are equipped with vibrating sides and arms to give an over-all treatment. Specially designed motors, motor mounts and floating panels operate within the equipment to induce circular, horizontal and vertical motion which lessens fatigue.



Photoelectric Cells Grade Eggs Into Six Shade Classifications

Eggs are sorted into six or more shell colors, ranging from white to dark brown, by the electric eyes of a new grading machine. Developed by the U.S. Department of Agriculture, the machine is sensitive enough to further divide white eggs into six shades between chalk and cream. An egg's color affects its price in certain areas, though color has no relation to its edible quality. The machine is based on the finding that brown shells reflect less blue light than white shells. A light beam is directed onto the egg as it passes over a candling device and two photoelectric cells, one sensitive in the blue and the other in the red portion of the spectrum, measure the reflected light. Activated by the light variations, a small motor and a system of cams and levers operate gates that drop each egg into its proper tray.

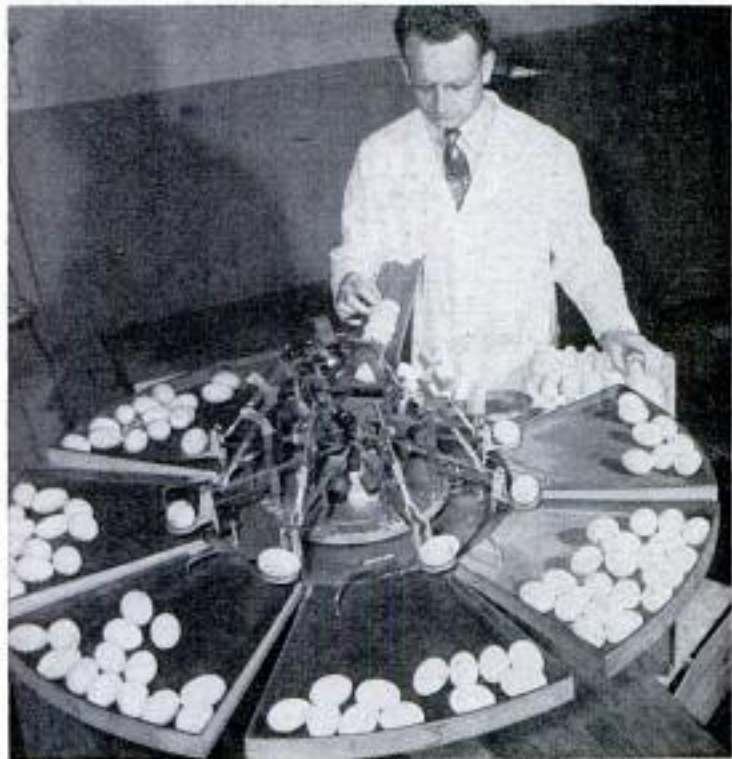

U. S. Department of Agriculture photo

Expert Predicts a Big Boost in Latin American Population

If its present rate of growth continues, Latin America will have three times as many people 47 years from now as it has today. Dr. Robert C. Cook, director of the Population Reference Bureau, Inc., recently said that Latin America is "the world's most explosive area of population growth."

Its growth rate is 2½ percent annually, compared to slightly more than one percent for the world. The estimated population of Latin America today, including the West Indies, is about 173,000,000, approximately equal to the combined populations of the United States and Canada.

Giant Drilling Barge Can Sink Well 20,000 Feet Deep



Towering four stories above the water, a giant floating drilling outfit is capable of drilling 20,000 feet below the surface. Described as the world's largest drilling barge by its builders, the unit has engines with an output of more than 5000 horsepower. It will be used for tapping oil fields beneath submerged areas and will operate in water up to 12 feet deep.

Coated Lamp Repels Insects

Fluorescent lamps are now available with a yellow coating that enables them to radiate the correct wavelength to repel all insects, as standard incandescent lamps now do at roadside stands, oil fields, gasoline stations and golf driving ranges. The tube is similar to the type now used in fluorescent light fixtures.



Thirty Irishmen With Shillelaghs



Beginning a game, sixteen scrimmagers in opposing rows await the ball—and action! Object is to disentangle the ball and send it flying toward enemy goal. Other players are stationed between center line and goals

GIVE 30 SPIRITED sons of Erin shillelaghs and room to use them, and you'll have either a fray on your hands or the national sport of hurling; perhaps a bit of both.

Hurling is a shin-cracking, wind-taking, fast sort of game that's been played in Ireland since ancient times—a sport halfway between lacrosse (from the North American Indians) and field hockey.

Fifteen men with cudgels stand on either side of the field, eight from each side facing each other in a scrimmage line at the center. The referee flings the ball between the

two teams. In a moment, sticks are swinging freely in an attempt to free the ball from the gantlet and whack it toward the goal posts. The ball may bounce from stick to stick; be struck with the hand or kicked; or caught in mid-air and sent flying again with a mighty whack of the shillelagh.

If a ball reaches the goal and soars over the crossbar it scores one point; if underneath, three points. After a goal, a member of the scored-upon team tosses the ball in the air, strikes it, and play continues. The battle lasts for an hour, with only a five-minute rest at the half. ★ ★ ★

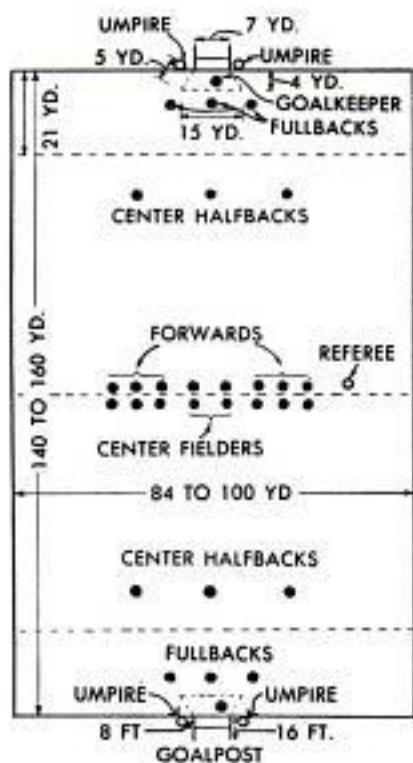

Diagram above shows hurling field with players in starting position. Not shown are linesmen—one on each side—who rule on possession of the ball when it goes out of bounds. Lines indicating 14 yards, 21 yards, 70 yards and halfway must be marked on field. Game is played all over Erin and in America by members of Gaelic Athletic Association. Soccer uses the same field and similar rules



A shot is blocked as a "horizontal" catches the swinging stick of a "vertical." Below, ball sails toward goal as goalie (most valuable man on either team) rushes to intercept it. Average player can knock ball 80 yards. Three points is scored if ball goes under crossbar



Fouled player gets a free shot as opposing team guards goal. He lifts ball from ground with stick, tosses it up and begins to swing. A hard hit coming up!



Revolving Fireplace Can Throw Heat to Different Parts of Room



Heat is thrown to different parts of the room by a homemade fireplace that can be turned in the direction of the dining, kitchen or living areas. Built from a steel tank four feet in diameter, it is mounted on a truck-wheel bearing and has brakes to prevent it from turning too fast. Mrs. Robert Thrun, a former student of architecture, designed the fireplace for her family's summer home at Sullivan, Me. A steel ring encircling the fireplace is grasped to change its position.

Disposable Mousetrap Holds Poisoned Bait

Quick death results for mice trapped by a disposable odorless mousetrap. It consists of a transparent plastic tube containing poisoned bait. The mouse enters the trap through a cone-shaped opening which closes after it, preventing retreat. The poisoned bait paralyzes the mouse and then kills it. Mouse and trap are then thrown away.

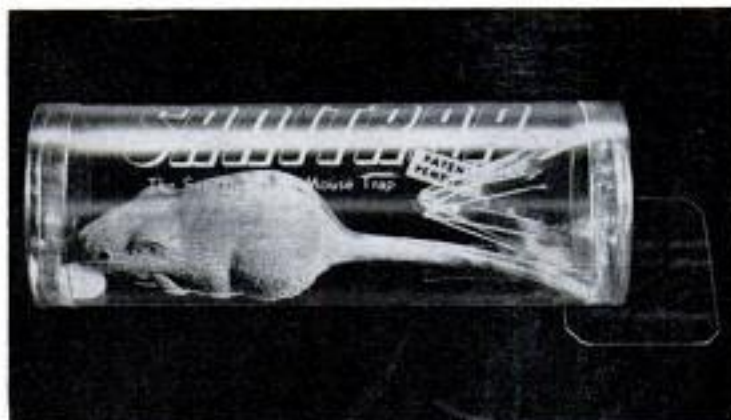

Pocket Calculator Aids Solution of Trigonometry Problems



Any problem in right-triangle trigonometry can be solved with a new pocket calculator that reduces all formulas to eight basic diagrams. The known quantities of a problem are printed in black on a typical right triangle, the unknown quantities are printed in red, making it simple to pick out the diagram that fits the problem at hand. The usual square-root tables are not required. The plastic calculator is designed especially for machinists, die makers and other craftsmen who need quick answers to mathematical problems.

Midget Gyros to Guide Missiles

Giant guided missiles will soon be steered to targets with the help of toy-size gyroscopes. Less than an inch in diameter and weighing under three ounces, the new gyroscope's precision rotor comes up to a running speed of 24,000 revolutions per minute in less than 10 seconds. They will also be used in aircraft instruments and fire-control systems.



Interior scaffolds moved along on tracks as ribs were mounted and roof was laid. Arches at rear are unfinished

Coliseum Without Girders

REINFORCED CONCRETE forming the Quonset-like Alabama Agricultural Coliseum in Montgomery makes possible a building without major interior supports. Eleven concrete spans rising to a point 100 feet above the floor support a concrete roof only three inches thick. Ramps instead of stairways lead to the 9060 permanent seats, below which on either side are two levels for livestock and exhibition quarters. A central battery of overhead lights illuminates the 130-by-260-foot area, four overhead gas heaters warm it, and a public-address system fills the building with sound.

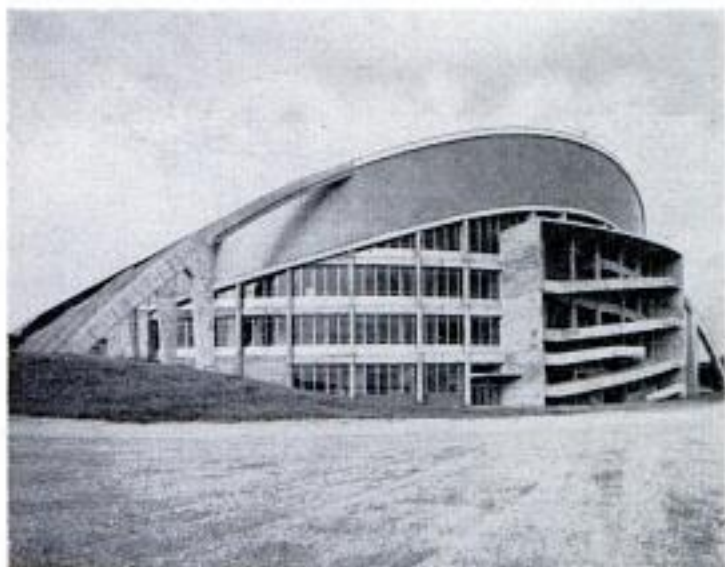

Glassed walls provide abundant sunlight for livestock pens and exhibition rooms below permanent seats. Note outside ramps

Horse shows, fairs and meetings keep arena busy. Lights, loudspeakers and heaters are suspended from ceiling

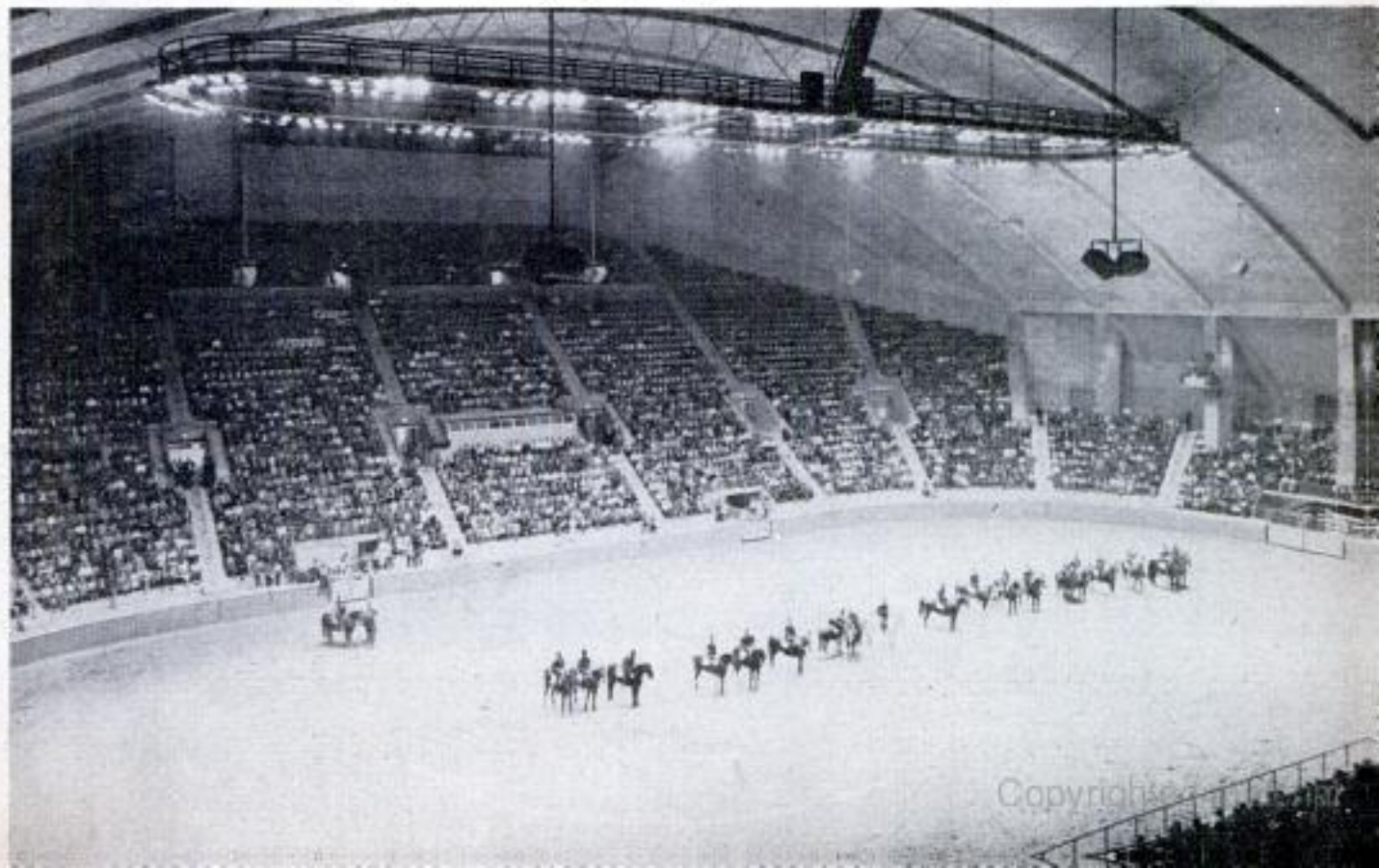

Where to Find Fish in a Stream

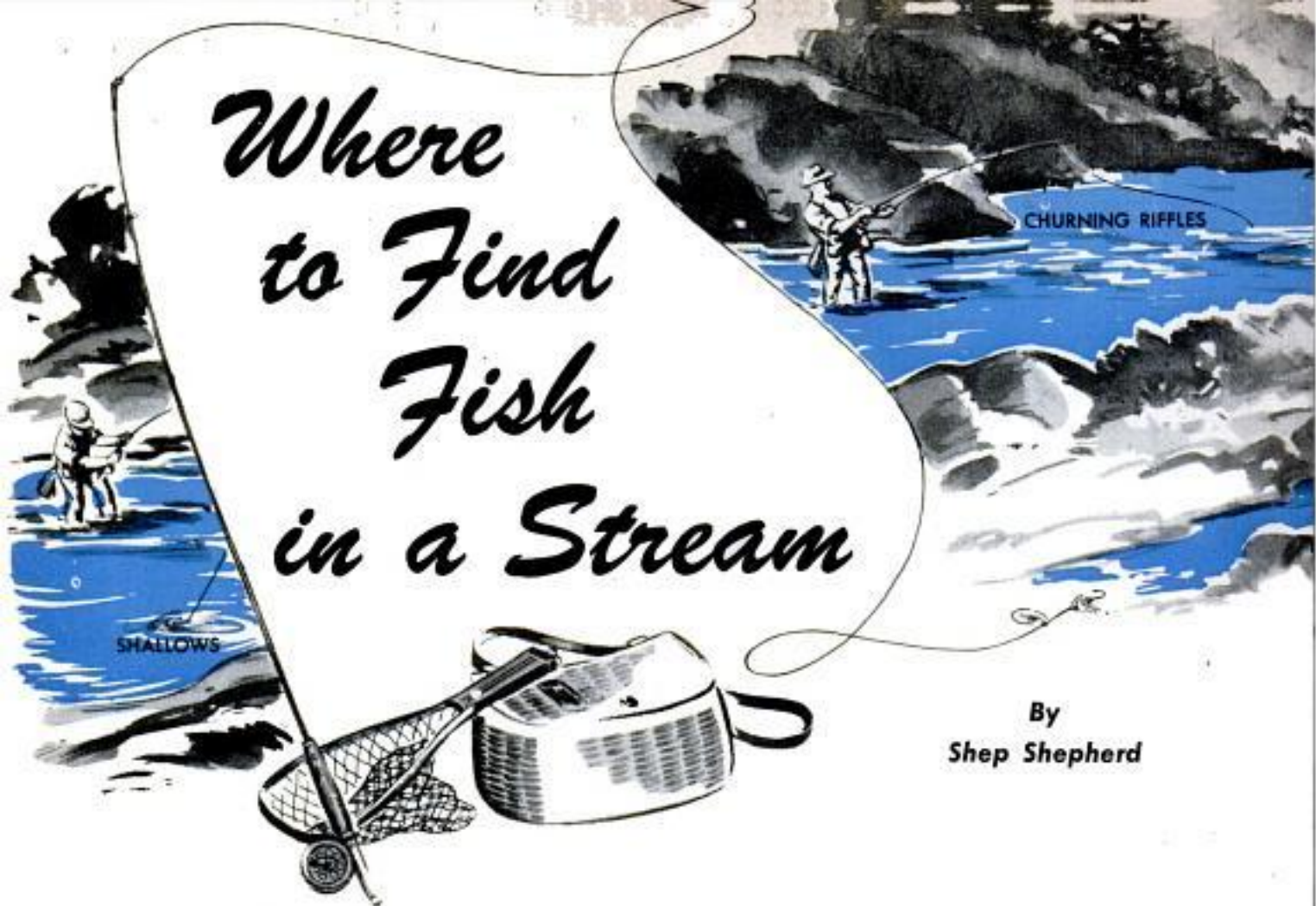

By
Shep Shepherd

OF THE 30,000,000 anglers who buy fishing licenses every year in the United States, surprisingly few give any time to a detailed study of the fish they hope to catch.

To catch fish, obviously, you must know where the fish are. Creel checks made by wardens along many of our favorite streams have shown that only an occasional angler fills out his limit while most anglers

go home with few or no fish. The fellow with the full creel didn't fill it on luck alone. He knew his stream, and where and how to fish it.

Fish are like people in two major respects. They have two demanding needs: food and shelter. To satisfy these two desires they seek out those spots in streams where food can be found and where there is also a certain amount of shelter from

On fast stream the angler tries pools near both rocks, then floats lure past fallen log into quieter water





fast currents and exposure. Fortunately for the wise angler, there are certain places in every stream that supply both needs.

Stream fish are wary, trout more so than bass though bass are skittish in exposed waters. Both fish tend to keep to the deeper, more sheltered waters where they are less likely to be seen from above, yet where the current brings food within reach. Often, when hungry, they move into shallow riffles to feed but dart to cover at the slightest sign of danger.

Many fishermen make two mistakes in stream fishing. First they go pounding up to the very bank of any pool they intend to fish, unwittingly scaring every fish in the pool. Fish can't hear normal sounds made above water. Loud talking won't disturb them, but walking or wading sends warning tremors through the ground and water that will put the fish down and stop feeding for quite some time. This is especially true on small streams running through

flatlands and meadows. On bigger, fast-moving streams there is less likelihood of scaring the fish by walking, but care must be used in wading to avoid dislodging rocks or creating unusual disturbances below the surface.

The average angler's second mistake is tramping from pool to pool, ignoring the shallow riffles between. The pools are the obvious places and apt to be overfished. Frequently you can put a good fish or two in the creel by floating a lure down through the riffles from a concealed position.

Most of our better fishing streams fall into two classifications — fast-moving streams flowing through mountains, heavily wooded terrain, and slower streams flowing through open, flat country. Let's take a look at both types of water for the signs that will locate fish.

In fast streams, look for patches of quiet water where fish can rest without fighting the current. Such spots will occur behind

Fishing from above, he lets lure drift on current behind boulder. Another good bet is quiet water behind him





Before wading into the water, angler cast his lure into white water beyond rock and watched it drift into the pool where he now stands. In six casts he took two trout on this side of the rock. Now he's casting across stream into fast water and letting lure ride downstream to another eddy

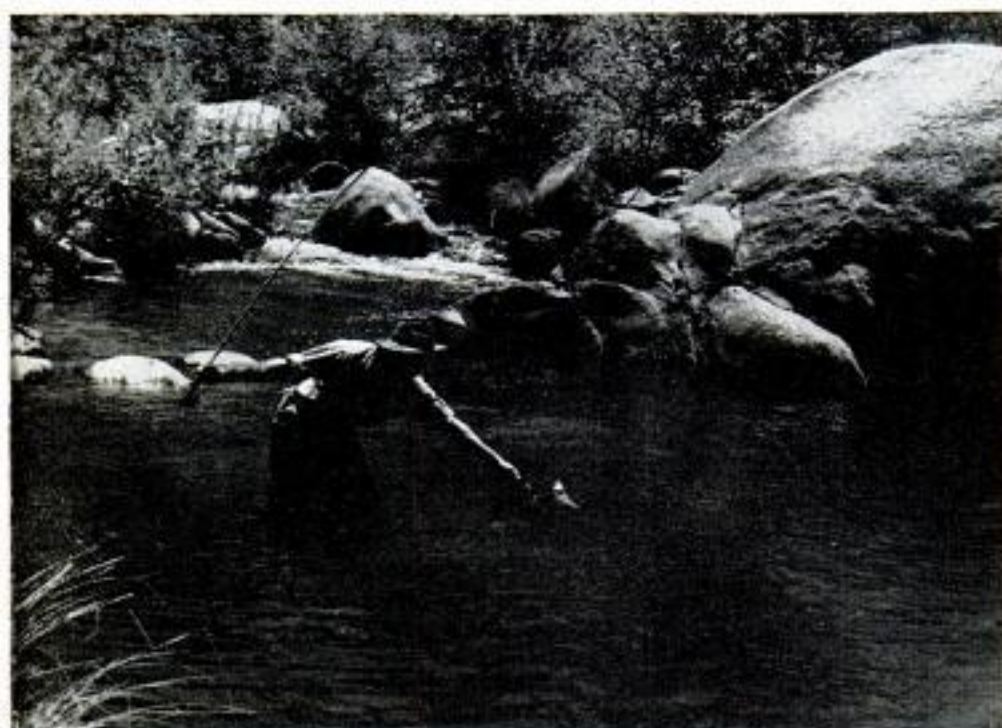

Here he cast into the white water between the rocks upstream. The lure, without weight, rode into the deep pool just this side of the boulder. With a snap it was taken by a sizable bass. Since the fish fought across the pool, angler will leave temporarily and return later for another try

Beaver dams frequently provide topnotch fishing holes on a trout stream. Work quietly through the best cover to pool's edge, making sure you're not silhouetted against the sky. Use a natural bait since there is little current to move artificial lure. Casting is difficult—but often profitable



large rocks, jams, fallen trees, sunken logs, in eddies where the current sweeps around outcropping boulders and under banks where the stream bends. Any place where you see a patch of dark water in the midst of churning riffles is a good place for a lure.

In such spots as an eddy behind a rock, use a long rod if you have a choice, and a short line so the lure can be dropped above the quiet water, allowing the current to carry it right to the fish that may be waiting there for such a morsel. If you have to wade to get in position, approach from one side rather than from above. In fast water of this nature a fish isn't likely to see you and you can get quite close if you avoid dislodging rocks directly above the fish.

The kind of lure you use will depend on the time of year and water condition. Early in the season when the water is high and roily, the best bet is a natural lure such as worms, grubs or salmon eggs on some streams. Often a small spinner placed a few inches in front of the lure will help get a strike. If the water is clear and low, try wet flies and small streamers. Drop the fly into the current three or four feet above the rock and let it ride naturally with the current around the edge of the rock into the eddy. Keep the line just taut enough to be able to set the hook if a fish strikes but not taut enough to interfere with the natural float of the fly. Don't give up after the first try. Send the fly through the eddy several times from both sides of the rock, then try dropping it gently over the top. Sometimes this last trick gets a fish when the other has missed.

Places where trees have fallen into the stream

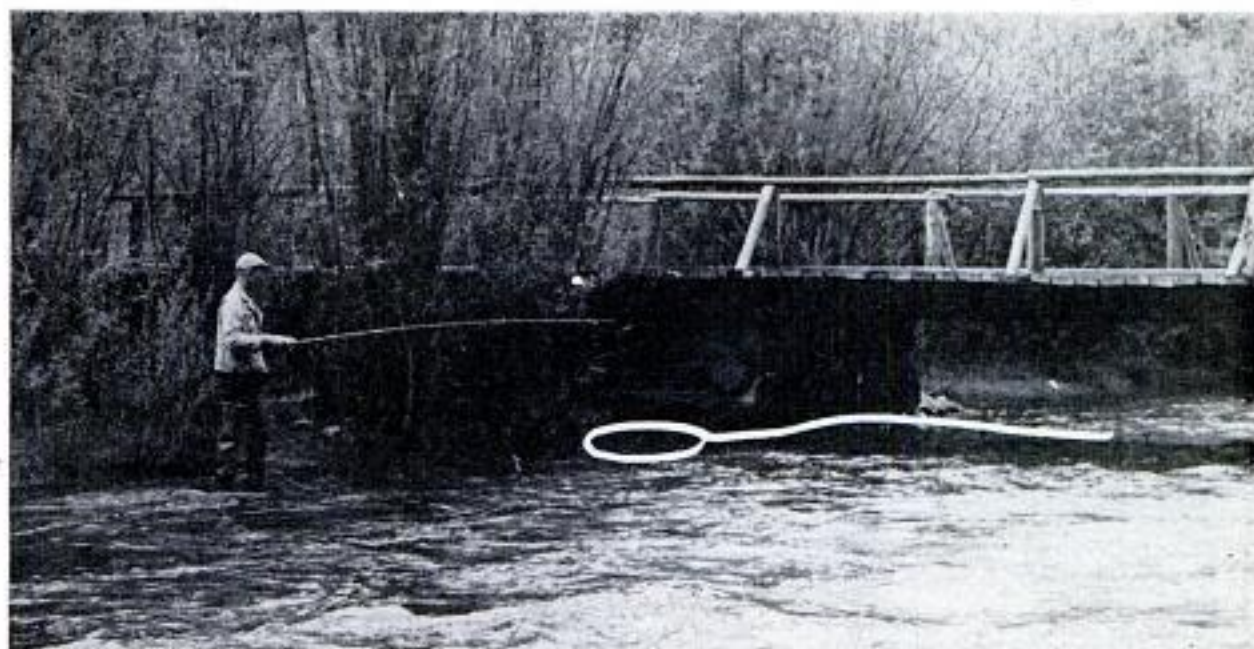

From upstream, work your lure under bridges, especially on hot sunny days when fish will be seeking the shade

make excellent feeding spots. Study the conditions here a few minutes to determine the best approach for your lure. If the tree trunk is submerged a few inches with water flowing over it put the lure in a few feet above that spot. Use no weight so the lure will flow naturally over the tree into the quieter water beyond. If part of the tree trunk is out of the water near the shore, allowing the current to swirl underneath it, float the lure through there a few times. Your lure will get snagged occasionally, but it will also get fish.

The V at the lower end of small islands in fast streams is frequently good for a fish or two. Cast the lure into fast water a little

above where it swirls into the eddy. That brings the lure to the waiting fish in exactly the manner it expects food to arrive. If you don't get a fish from one side of the V, cross the stream and try from the other side. Never make a cast so the leader falls across the quiet water.

Many of our back-country streams are crossed by old wooden bridges, which means that near-by waters are usually well fished since they are easily accessible. Oddly, however, many anglers fish near the bridges but few fish under them. It is a good place to try if the sun happens to be bright and the weather warm. Fish seek

(Continued to page 238)

From concealment behind tree, angler dropped lure straight down into pool and took a bass on his first try. Right, try small streams that meander across meadows, fishing cutbacks near banks where water is deepest



\$5000 Sport Car Has 205-Horsepower Engine, Glass-Fiber Body



Powerful, sleek and roomy, a sport convertible in limited production near San Francisco can be serviced anywhere in the United States. Called the "Edwards," it is built of standard American parts. The molded glass-fiber body is mounted on a shortened Ford chassis powered by a Lincoln 205-horsepower engine with a Lincoln Hydra-Matic transmission. The \$5000 car's wheelbase is 107 in., weight 2800 pounds.

British Sherpa Airplane Headed for High Places

Rotating wing-tip controls and a flexible wing distinguish the Short Sherpa, Britain's new high-altitude research aircraft. The wing is designed to deflect in bending, without twisting under its aerodynamic load. Two Turbomeca jet engines will power the plane. The air intake is located at the top of the fuselage, behind the pilot. Its name was inspired by Sherpa Sen Tensing, who last summer was one of the first two men to climb Mount Everest.

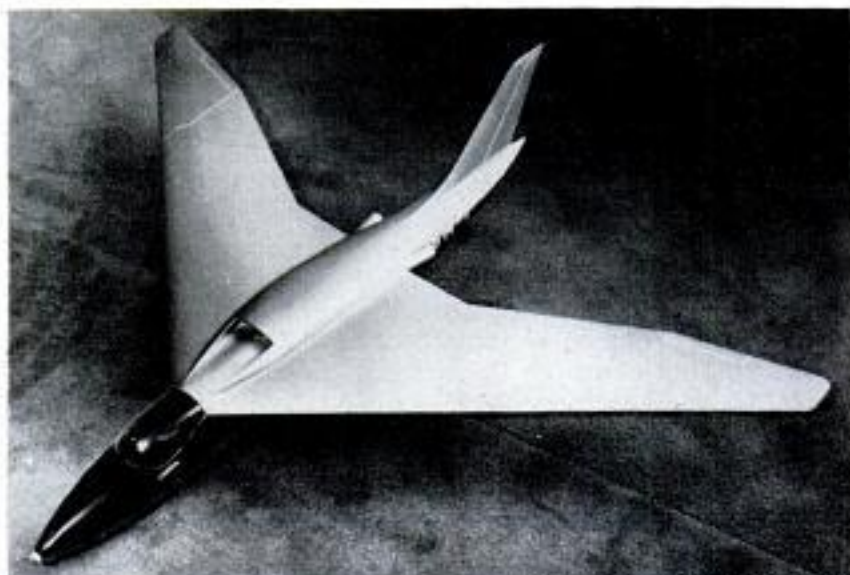

British Information Services photo

Jeep for Mail Carriers Mounts Steering Wheel on the Right



Right-side steering lends a Continental touch to a mail truck built by Willys for American use. Rural and suburban carriers save time with the truck because they don't have to slide across the seat to reach mailboxes. At the left of the driver is a handy shelf for sorting of the mail en route; the door on his right contains an oversize window so he can reach mailboxes of varying heights. The two-wheel drive delivery is also manufactured with the steering wheel on the left.

Navy's Shipboard Radar Gauges Speed of Landing Carrier Planes

Jet aircraft approaching carriers are "clocked" by an electronic device that indicates whether or not they are coming in at a safe landing speed. Installed on the carrier, it "watches" planes approaching for a landing and warns the landing signal officer if the plane's speed is too fast or too slow. The officer can then wig-wag orders to the pilot, either guiding him down or waving him off for another try. The Navy's new equipment takes into account the speeds of the aircraft as well as the carrier, coordinating this information with the wind's speed to give a reading of the plane's true air speed.

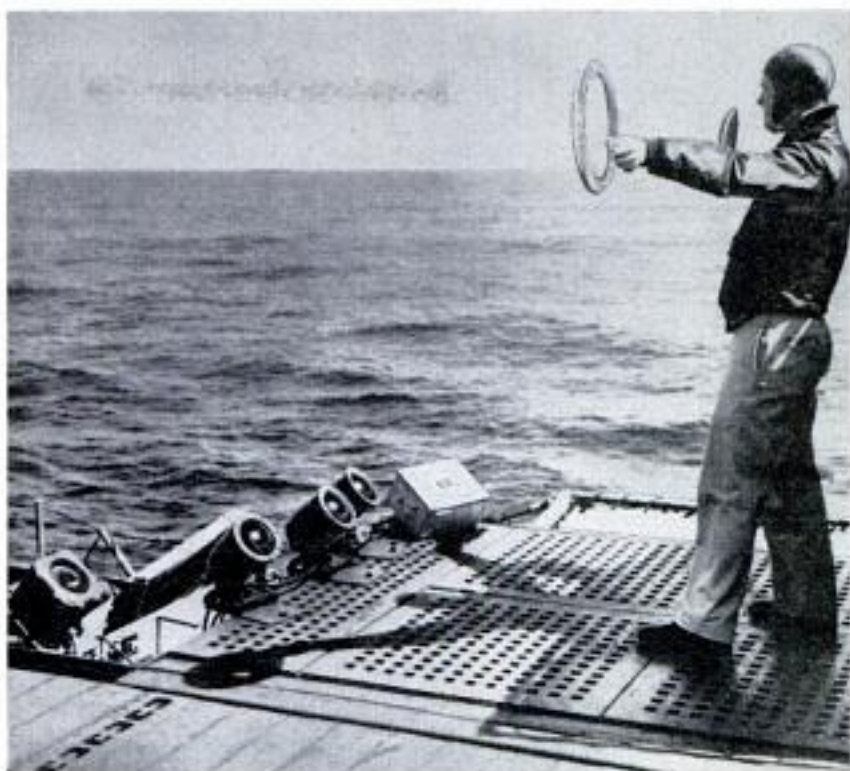

Transparent Typewriter Bar Aids Typist in Reading Copy

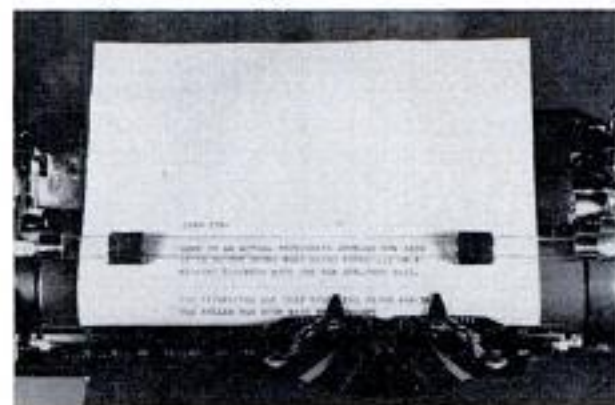

Typists can see every word on an unfinished page when the typewriter bar that holds the paper against the roller is transparent. Made of clear plastic, the bar doesn't have to be lifted to see what's under it.

Fingerprint Accompanies Check

Bad news for check forgers is a machine which takes your fingerprint on a roll of chemically treated paper and develops a picture of the print. The photo is attached to the check for further reference.

Rubber Raft Scoots Across Ice or Water to Rescue Drowning Skater

Rescuing a skater who has fallen through the ice isn't so difficult with a lightweight rubber raft used by police in Hamburg, Germany. The raft can be paddled across open water or pulled along on top of thin ice that wouldn't support a man's weight. A multi-prong hook is thrown out in front of the raft and digs into the ice so the rescuer can take up the rope and move the craft. Precious minutes are saved by using the raft.





Disaster unit carries portable power unit and winch, axes, ladders, stretchers and aluminum boat on roof

Mobile Disaster Unit Carries Rescue and First-Aid Equipment



Communication section in front of trailer has two-way radio, portable phones and public-address unit

EQUIPMENT for handling first-aid and rescue work in almost any emergency is carried in a mobile disaster unit built for the city of Marshfield, Wis. The 43-foot-long unit consists of a house trailer and truck that can speed along at 50 miles per hour. The trailer is equipped with stove, sink and refrigerator, and was built to serve as an emergency hospital and communication center. Medical equipment includes an examination table bolted to the floor, surgical tools and medical supplies, oxygen and plasma, resuscitation outfit, splints and blankets. The communication system has an FM transmitter and receiver plus two walk-around radio phones and a public-address system.

Left, portable power plant and oxyacetylene unit are stored in truck body; right, resuscitation outfit



Radio Television Electronics

FOR SAKE OF THE RECORD

By Emanuel J. Marcus

MINIMIZING record wear is of interest to every owner of record-playing equipment. If you are a record collector you have an important investment well worth protecting. For a serious listener it usually runs into several hundred dollars.

Record grooves are delicate and can be quickly damaged by worn out chisel-shaped playback needles. Accordingly, it makes sense to play your valuable, and hard-to-get, records with a small ball-shaped stylus tip of the most durable material. Stylus and record engineers, and manufacturers, have always realized this and have selected more and more durable materials to use as phonograph styli. Only in recent years, through the production of reasonably priced diamond styli, has this material been available for the general public, although it has always been preferred by professional users.

The stylus and the groove are the only parts of the entire system which are subject to rapid physical deterioration. Pressures exerted between the two are in tons per square inch; groove distance traveled on one LP (long playing) record is almost one mile in length, and stylus vibrations run over 20,000 cycles per second. Figs. 1 and 2 illustrate very clearly the cause and remedy for minimizing record wear. The worn stylus sinks into the groove and sharp cutting edges cause high surface noise and rapid deterioration of record life. The young lady in photo A is using a stylus inspection microscope. Photo B shows an osmium needle after 12½ hours play; the sapphire needle C has been used 40 hours, while the diamond stylus, photo D, is pictured after having been in use 700 hours.



"Electronics Made Easy"

1954 "LITTLE GIANT" LOW-COST

By Lothar Stern

I NTERROOM communications systems have a wide variety of uses in homes, schools, factories and offices, or anywhere that instant communication between two or more widely separated points is required, as illustrated. This particular system was designed to include one master station and from one to four substations. The master station can call or listen in on any of the substations while each substation can originate a call to the master station. If desired, all sounds from the remote stations can be shut out from the master station, yet calls may be received from any of the substations, if necessary.

In spite of the versatility of the system, it is relatively simple and inexpensive to build. Even if all parts are purchased new, the cost of the master station is less than \$22.00, while each substation can be constructed for about \$7.00. Since none of the component values is particularly critical, many of the parts can be salvaged from the "junk box," or from an old radio that has been discarded. For these reasons, this versatile and useful construction article was selected for the 1954 annual "Little Giant" project for advancing radio students and experimenters.

The circuit consists of a two-stage amplifier, an a.c.-d.c. power supply and a simple switching arrangement. The student will note that in tracing the path of the signal on the schematic-circuit diagram, Fig. 2, it is seen that with the press-to-talk switch (S1) in the listen position as shown, the substation is connected through the selector switch (S2) directly across the primary of the intercom input transformer T1. The intercom transformer used in the model was a Stancor type A-4744; these

RESISTORS

- R1 10-OHMS, 1/2-WATT
 - R2 10-MEGOHMS, 1/2-WATT
 - R3 1-MEGOHM, 1/2-WATT
 - R4 470,000-OHMS, 1/2-WATT
 - R5 1-MEGOHM VOLUME CONTROL—(MALLORY U-53)
 - R6 150-OHMS, 1/2-WATT
 - R7 4700-OHMS, 1/2-WATT
 - R8 220-OHMS, 1/2-WATT
 - R9 150-OHMS, 10-WATTS W.W.
- No. 1 TAPER

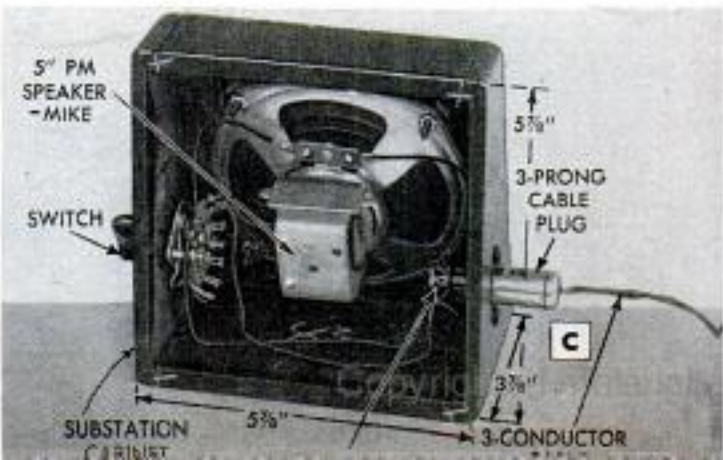
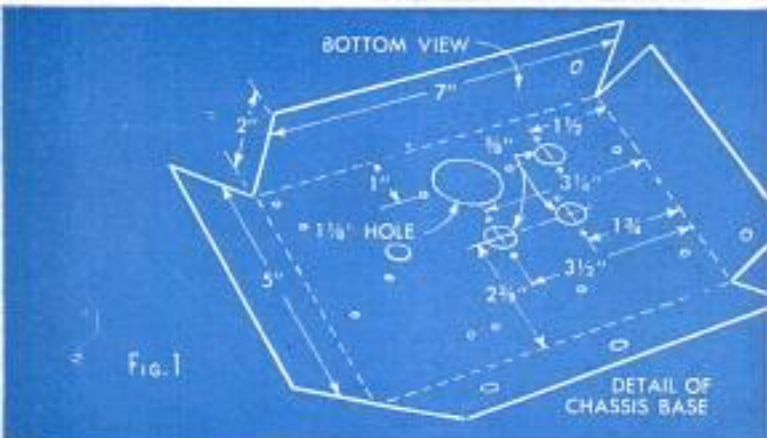
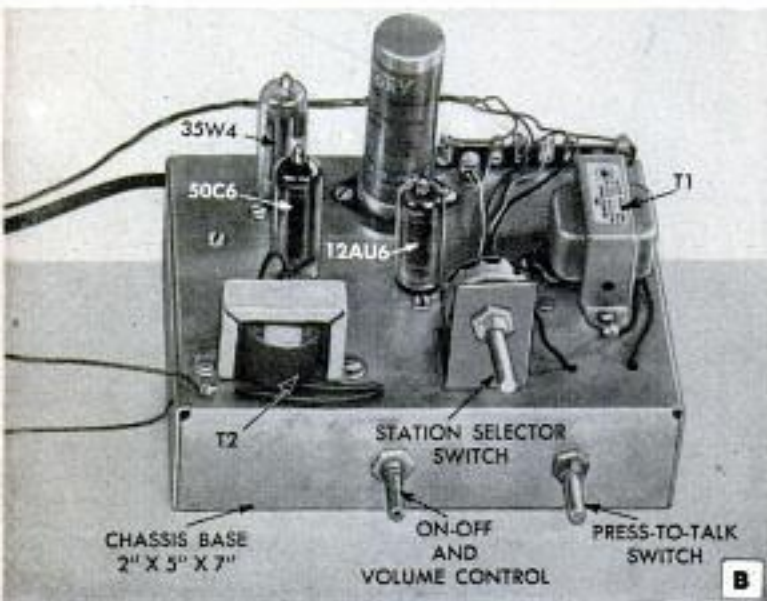
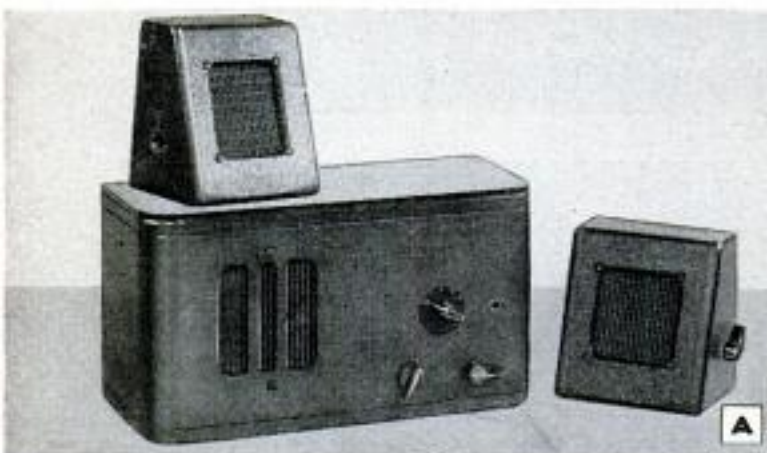

BACK-LOADED CABINET FOR SUPER-FIDELITY HOME PHONO

(Continued from February issue)

NOW THAT the amplifier has been completed, we are ready to house it, and the 3-speed record player, in the back-loaded chairside cabinet, photo G. All joints must be glued and nailed. Plywood of $\frac{3}{8}$ -in. thickness is specified and with built-in bracing this thickness is sufficient without adding unnecessary weight.

The assembly order should be as follows: Item 11 (back, bottom) is fastened to item 3 (speaker floor). Then assemble item 5 (speaker side) and item 10 (deflector). Next, the left side panel, and item 7 (record shelf). Item 8 (7-in. album spacer) can be glued and nailed in place. From here on, no preference as to order.

In assembling the cabinet, allow $7\frac{1}{10}$ -in. width in the amplifier compartment to allow easy insertion of the 7-in.-wide amplifier chassis. Follow Figs. 6 and 7 and check with the list of cabinet items. The amplifier-speaker panel is detailed in Fig. 8. Holes A and A, are counterbored 1-in. diameter from the back, with a $\frac{1}{2}$ -in. hole through the front. The red dial-light jewel is pressed into the $\frac{7}{8}$ -in. hole; the socket clamp for the lamp is held to the back of the panel with short wood screws. Note the groove for the speaker wires in Fig. 6 assembly; panel item 6 in Fig. 7 mounts tight against item 5, therefore space for the wires from the speaker to the amplifier must be provided. Three wood screws hold the speaker-amplifier panel (item 6) in place in the cabinet. A flat-head screw is inserted from the bottom,

(Continued to page 244)

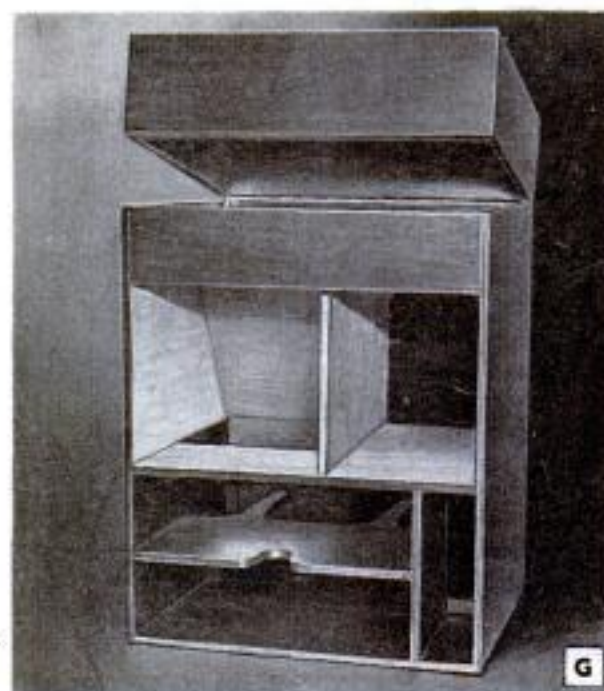

LIST OF CABINET ITEMS

Item	Req'd	Description	Reference
①	2	Sides	15" X 20 $\frac{3}{4}$ " X $\frac{3}{8}$ "
②	1	Phono floor	15 $\frac{7}{8}$ " X 14 $\frac{1}{4}$ " X $\frac{3}{8}$ "
③	1	Speaker floor	15 $\frac{7}{8}$ " X 14 $\frac{1}{4}$ " X $\frac{3}{8}$ "
④	1	Bottom	15 $\frac{7}{8}$ " X 14 $\frac{1}{4}$ " X $\frac{3}{8}$ "
⑤	1	Speaker side	8 $\frac{1}{2}$ " X 13 $\frac{1}{4}$ " X $\frac{3}{8}$ "
⑥	1	Spkr. and amp. panel	8 $\frac{3}{4}$ " X 15 $\frac{3}{4}$ " X $\frac{3}{8}$ "
⑦	1	Record shelf	13" X 14 $\frac{1}{4}$ " X $\frac{3}{8}$ "
⑧	1	7-in. album spacer	7 $\frac{7}{8}$ " X 7 $\frac{7}{8}$ " X $\frac{3}{8}$ "
⑨	2	Top, back and front	15 $\frac{7}{8}$ " X 3 $\frac{3}{8}$ " X $\frac{3}{8}$ "
⑩	1	Deflector (baffle)	8 $\frac{3}{4}$ " X 10" X $\frac{3}{8}$ "
⑪	1	Back, bottom	15 $\frac{7}{8}$ " X 8 $\frac{3}{8}$ " X $\frac{3}{8}$ "
⑫	1	Top of lid	16 $\frac{1}{8}$ " X 15" X $\frac{3}{8}$ "
⑬	2	Front and back lid	16 $\frac{1}{8}$ " X 4 $\frac{3}{8}$ " X $\frac{3}{8}$ "
⑭	2	Side of lid	14 $\frac{1}{4}$ " X 4 $\frac{3}{8}$ " X $\frac{3}{8}$ "
⑮	1	Album stop	2 $\frac{1}{4}$ " X $\frac{1}{2}$ " X $\frac{3}{4}$ "
⑯	1	Piano hinge	14"

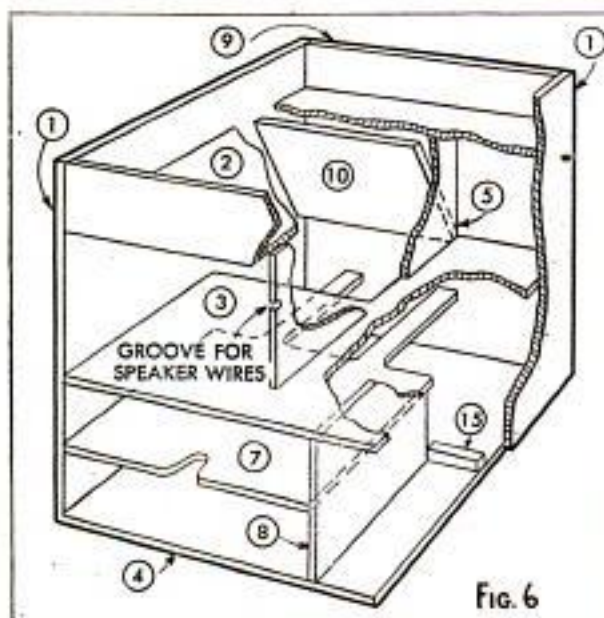

FIG. 6

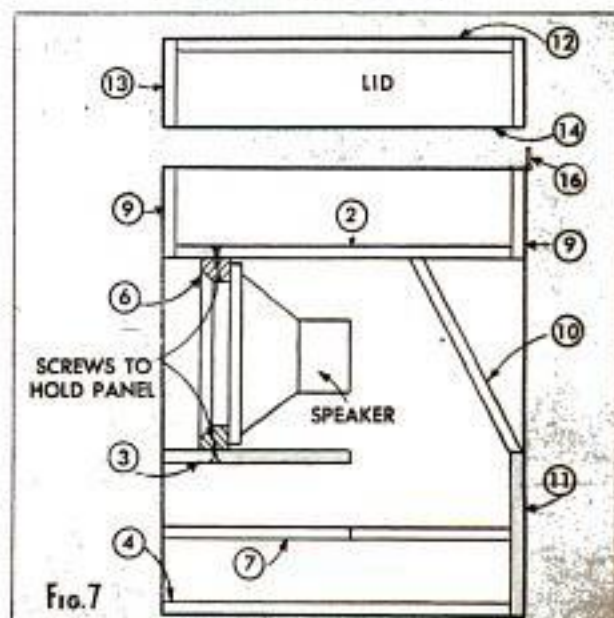

FIG. 7

the POPULAR MECHANICS CRAFTSMAN

There's plenty of room for feathered visitors and no nest-cleaning problems with this

MARTIN MOTEL

LATE in April, when martins are winging northward, they will be attracted to your yard or garden by this unusual martin house. Since the nest sections are easily removed, cleaning and storing them are simple operations.

Begin construction by cutting the nest floors and ceilings to the dimensions shown on page 162. Then attach the perch supports, as detailed at the right. Four nest sections are needed, so four sets of floors must be made. Each section is assembled after the sides have been cut to the proper size. The best way to begin assembly is to fasten the entrance-hole strip to the floors first and then add the other side pieces. The guide strips at the top of each box and the ceiling braces near them should be positioned carefully, as these must fit snugly into the center supporting column.

Next, the supporting column is made. The center of this column is an air shaft which ventilates each nest by means of $\frac{1}{2}$ -in. holes in the back wall. Note bolt holes drilled in the hardwood cleats at the bottom of the column. These are for the bolts which secure the column to a wooden disk or cross fastened to the end of a 15 to 25-ft. pole on which the house is mounted. The base of the roof consists of a 22-in. sq. frame of $\frac{3}{4}$ x 2-in. members which is faced on the bottom with a panel of $\frac{1}{4}$ -in. exterior plywood. Before finishing the roof, set the roof-frame assembly on the supporting column and locate and drill the holes through which the roof is bolted to the column. Now the roof is completed as detailed at the right. Orange-crate slats make

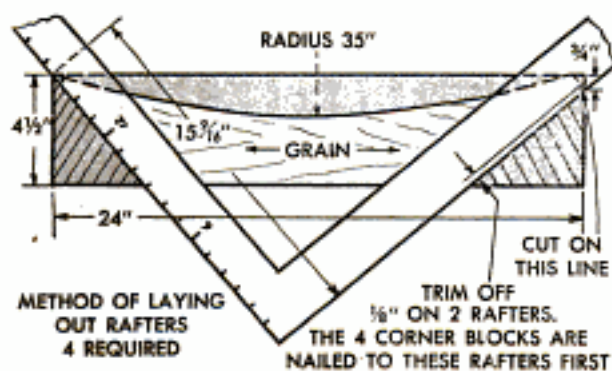

By
A. L. Mills

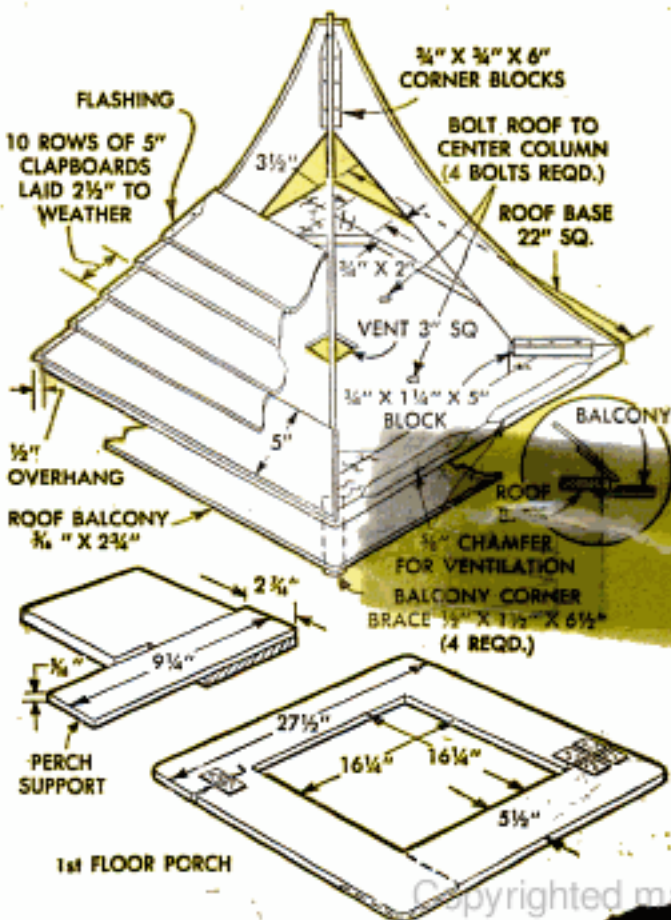

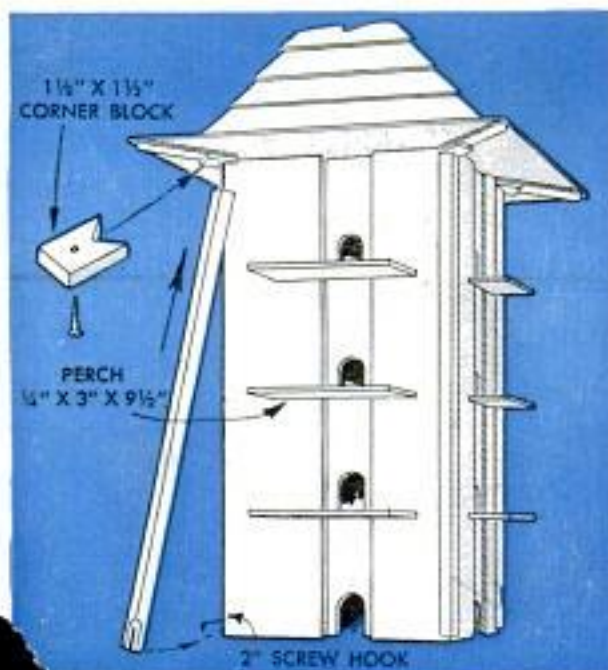

ideal clapboards for covering the roof. Finally, a drip cap, 3/4 in. thick and 4 1/2 in. sq. is made to cover the open end of the roof. Any finial you desire can be attached to this, and four dowel perches inserted in it, as seen in the sketch at the top of the first page.

The nest sections are now placed in position on the supporting column. These are held together by small flat hooks fastened to the underside. Four corner posts are cut from 1 1/2-in. L-shaped molding, the length of each determined by cutting and fitting. A slot in the bottom of each post fits over a 2-in. screw hook, and the top of the post engages a notched corner block. Finally, the first-floor porch is assembled and held in place by four turn buttons screwed to the bottom of the nest sections. Two sides of it are hinged so that it can be removed easily when cleaning the nests. ★ ★ ★

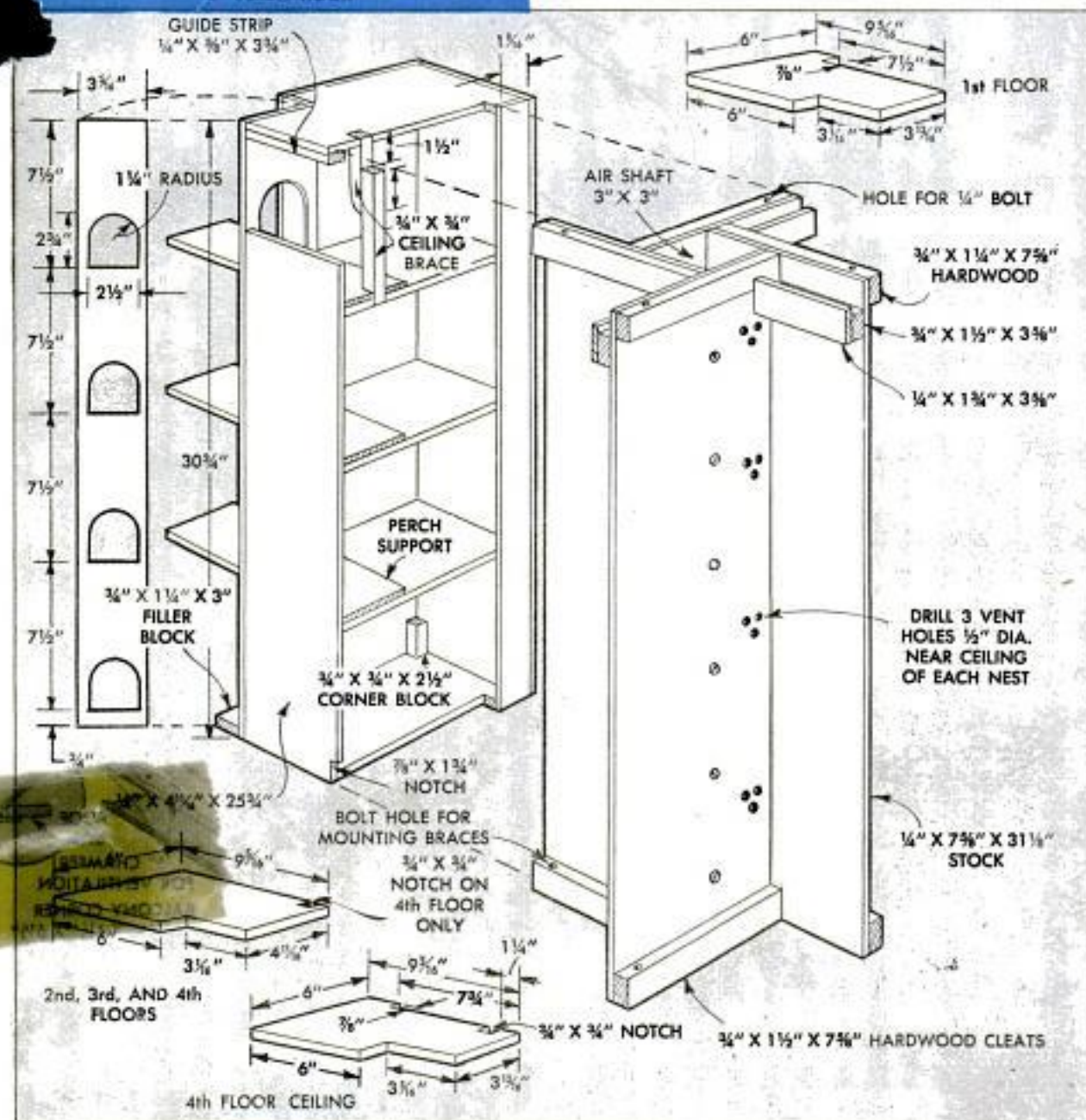

Slack in Mooring Lines of Boat Taken Up by Rubber Band

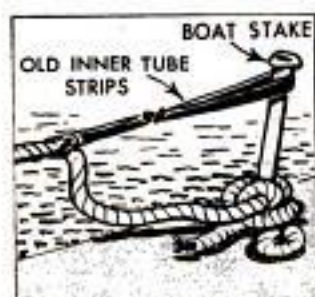

Large rubber bands cut from an inner tube can be used to take up the slack of a mooring line for a small boat. Tied between the mooring stake and the line in the manner shown, the rubber

will take up the slack when the rope is loose, but it will allow the rope to take the full strain when the rope is extended. By keeping the mooring line out of the water, the rubber band prevents the line from becoming waterlogged with each rise and fall of the tide, thus helping to avoid eventual rotting and parting of the line.—George Brook Taylor, Daytona Beach, Fla.

Hose Section Over Hoe Handle Measures Garden Rows



When marking out garden rows, or setting out bushes and plants, the job of spacing them properly can be simplified if a small section of garden hose is split and slipped

over the handle of your hoe. In laying out a vegetable bed, for example, the first two rows can be marked. Then the hose section is moved along the hoe handle until it indicates the distance between rows. As you move down the rows, this measurement can be used to make sure the same distance is maintained between rows.

Postage Stamps Carried Conveniently Inside Pen Barrel



Turn Button on Workbench Aligns Boards for Marking

When marking wood on your workbench against a pattern or template, the job will go much faster if the end of the bench is fitted with a turn button against which the work and the pattern can be butted simultaneously. When not in use, the button turns so as to be out of the way. For further convenience, a yardstick can be fitted to the edge of bench, as shown, to be used in conjunction with the turn button.

Removing Grease Spots From Rugs

To remove grease spots from rugs and upholstered furniture, add water to baking soda to make a paste and rub liberal amounts into the spotted areas. Allow the paste to dry and then remove with either a brush, vacuum cleaner or carpet sweeper. Repeat this operation several times if stain is stubborn.

Ted Otsu, Vancouver, B. C., Can.

As many as a dozen postage stamps can be carried inside some types of ball-point pens without affecting their usefulness. Open the pen, as shown in the photo, by unscrewing the upper portion of the barrel from the lower end. Then curl a strip of stamps so it fits inside the pen barrel and around the ink cartridge. Then reassemble the pen and use in the normal manner.

Ken Murray, Colon, Mich.

☐ Spar or quick-drying varnish should be used on rattan furniture that may be exposed to sunlight and rain. Clear lacquer or white shellac, may be used if the furniture is to be used indoors.



Martin



Johnson

Here Come the **OUTBOARDS**

Part I—By Frank N. Stephany

WITH TRAFFIC-JAMMED highways quickly making "driving for the fun of it" a thing of the past, millions of average Americans are turning to outboard boating as one of the most enjoyable and relaxing ways of spending their vacations and summertime weekends. They're getting out on the thousands of lakes and rivers where there is still plenty of elbow room. And they're discovering in rapidly increasing numbers that outboard boating is a sport that the whole family can enjoy.

The development of the outboard motor from the troublesome noisemaker of the past to the dependable, economical power plant of the present has contributed more than any other factor to the popularity of boating. Many outboard boaters own both motor and boat, while others have their own motors and simply rent a suitable boat when and where they have need for it.

The easily handled, two-wheel car trailer has done much to spread the boating fever. With these trailers, anchorage or



Champion



Mercury



Evinrude



Bucchignani



Couple of fishing rods and an outboard motor-boat are perfect ingredients for summer family outings

Fastening safety chain to motor, as below, saves watching it sink to bottom in case clamps work loose

docking space is no longer a must, as the boat can be "docked" right in the garage or backyard and trailed many miles, if necessary, to almost any body of water that the boater wants to navigate. The trailers are designed so that one or two people can launch a good-sized boat without difficulty.

Among the many improvements on the outboard motors themselves have been the incorporation of twist-grip speed controls and the gear shift. This has been done even on some of the smaller motors. Of more interest to the fisherman and the man who likes to take his family and friends cruising, is the ear-pleasing quietness that some motors have achieved by means of engine mufflers and a new cushioning feature. This brings the noise level of the motors down to the point where passengers can hold conversations in normal tones of voice even while running their boat at full throttle. New streamlined housings are easy to open for servicing and, if you have not



Photo below shows a 14-ft. utility boat powered by a 25-hp. motor being pulled from launching ramp after day's outing. This type of 2-wheel trailer has made outboarding practical for thousands of people

Certain photos and information courtesy of the Outboard Boating Club of America



MARCH 1954





If the car can't be backed to the water, even a boat-and-trailer outfit as large as this one often can be wheeled into launching position by hand



Launching the boat from the trailer is seldom more than a one-man job. Though necessary in this case, trailer frequently does not enter water this far

operated an outboard in recent years, you probably will be surprised at the ease of starting—the automatic-rewind starters have won the outboard-boater's battle with the pull rope. Plug-in fuel tanks that give much-wanted extra hours of cruising, clamp-on remote controls, an automatic boat bailer and, for larger motors, an electric starter are additional features that add to the enjoyment and convenience of outboard boating. Now, too, many of the larger motors are so versatile that they will drive the boat at 20 to 30 m.p.h. and still give fine performance at trolling speeds.

If you're thinking about buying a motor, you'll find a number of excellent brands on the market. There are several things that will determine the size of motor required. One of the first considerations is whether or not you want speed and, then, the size and type of boat on which the motor is to be used. The smallest of the motors, which are available as low as 1½ hp., are intended primarily for dinghies, prams and canoes. The 5 to 7½-hp. class is most popular and that, of course, is because this size of motor

Utility boat has a small forward deck and usually a V-shaped planing-type hull. Capable of fair speed



Hydroplanes are made in a variety of designs, all of them intended for racing. Handle largest motors



is suitable for the average-sized rowboat, car-top boat and the smaller utility boats frequently found in summer-resort areas. Though it always is safest to check your boat for seaworthiness, take special care to see that a borrowed or rented hull is in good condition before mounting a motor of this size on the transom. If a motor larger than this is to be used, it is wise to use it only on a hull that is designed to handle that much power. The 10 to 25-hp. motors are intended for the larger utility craft, runabouts, cruisers and hydroplanes, and these normally would be selected for a particular hull. Another thing to keep in mind is that the weight of the motor will be an important factor if you intend to carry it around in the trunk of your car. Outboard motors are designed to be as light as possible, but the chore of lifting a heavy motor in and out of the trunk and carrying it down to the boat may not be worth the extra speed.

The horsepower of the outboard motor should be balanced with the size of the boat. So, if you buy both, get a boat and

Runabout is faster and fancier than utility boat with deck amidships. Comes in lengths up to 18 ft.



Outboard Cruisers range to 20 ft. and take one or two 25-hp. motors. Remote controls should be used





Here's a man boarding a boat properly. Notice how he's carefully stepping on the seat—not the gunwale. It's easier and safer to do it the right way

motor that are balanced or, if you already have a motor, be sure that the hull obtained is suitable for the motor. A motor that's too small for the hull won't give the efficiency you want, while a motor that is too large will eventually damage the boat as well as create tricky handling qualities that might prove dangerous. Four basic hull designs are shown on page 166. These are available in a wide range of sizes, design, and quality and can be purchased complete or in kit form.



Reluctant little girl on dock knows that she can't swim. The boat shouldn't carry more than four persons, so a load like this almost guarantees swamping

What if the motor conks out? As dependable as these things are, there's always the possibility that something might go wrong. So, carry along a paddle or a pair of oars—just in case. Emergency repairs to the outboard usually aren't difficult and, if a few tools and spare parts are carried along in the boat, you probably can have her running like new in a few minutes. Take along an extra set of spark plugs, a couple of shear pins and possibly a spare starter cord. A



Joyriders cutting across bow of another craft just made it this time, but odds are all against them

the seating comfort of the passengers, and acting as life preservers.

When boarding the boat from a dock, step gently into the center of the boat, crouching low and grasping the gunwale. Either load the motor and gear into the boat before stepping aboard or set them on the dock within easy reach. Then, board the boat and retrieve the gear and motor from

the dock. Naturally, if there is someone to help load the boat, the job is simplified considerably. After slipping the motor bracket over the center of the transom, tighten the clamp screws by hand. Then connect a safety chain or rope to the motor. The safety chain is secured to the boat so that the motor will not be lost if it should work loose from the transom.

Note how wrong motor tilt affects the performance of boat. Motor in lower photo is tilted correctly

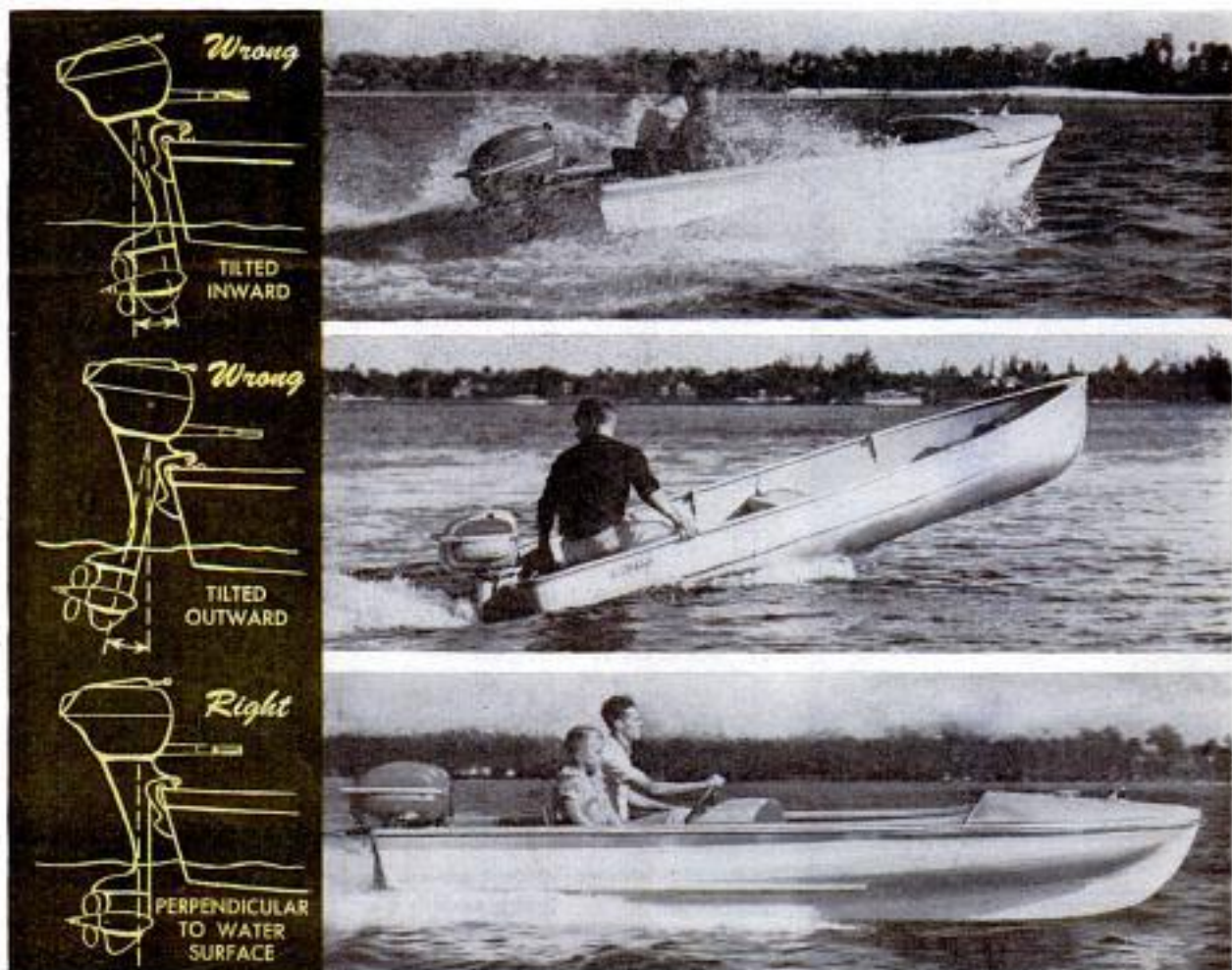

Unless the motor already is adjusted for the boat, you will want to check the motor tilt. The photos at the bottom of the opposite page show how a motor tilted either inward or outward will cause the bow to dig into the water or ride too high. Adjust the tilt bracket so the drive shaft is perpendicular to the water when running.

Loading the boat (that is, the number and location of the passengers) is extremely important to safety and the handling of the boat. Even though there is seating room, the smaller boats (12-ft. class) are not designed to carry more than three or four persons—no more than three if the water is choppy. Unless the boat is one of the larger family-type craft, don't expect to carry more than three passengers and yourself with safety. For the best handling characteristics and maximum speed, in addition to safety, it is important to distribute the load evenly over the length of the boat. The motor, of course, is on the stern and, unless you have remote controls, you'll be back there with it. So seat extra passengers and stow gear toward the bow, balancing the boat to keep the bow down on the water.

If the boat is beached or docked in shallow water, push off into deeper water before starting the motor—here's where the paddle will come in handy. When starting the motor, keep your eyes forward and a hand on the throttle. Take it slow and easy as you pull away from the dock—watching for boats that might approach from the other side of the dock—and be sure the boat will clear the dock before you turn. Note detail D at the right.

When operating a boat you have certain "rights," certain legal responsibilities and certain procedures to follow that are a matter of safety, courtesy and common sense. For example, remember that boats without motors have the right of way over outboards and that you are legally responsible for your wake.

When approaching another boat head-on, both boats should veer to the right and then straighten out on course, detail A. Cut across the wake at an angle, B, so there'll be no chance of being swamped. When overtaking another boat, the one being overtaken has the right of way. As you cross the wake, again cut through the waves at an angle, detail C. Docking takes practice but is not difficult, especially with a gear-shift motor. Come in toward the dock slowly against the wind, tide or current, whichever may be the strongest, detail E. Just before reaching the dock, cut off the power or shift into reverse.

Becoming a top-notch skipper requires experience, but you'll be welcomed immediately into the boating fraternity if you start out by using good judgment and courtesy. Next month, part II of this article will tell how to care for and maintain an outboard motor. ★ ★ ★

This is as silly as it is dangerous. Might look fast, but having bow high in air slows down boat, obstructs vision and makes craft hard to handle

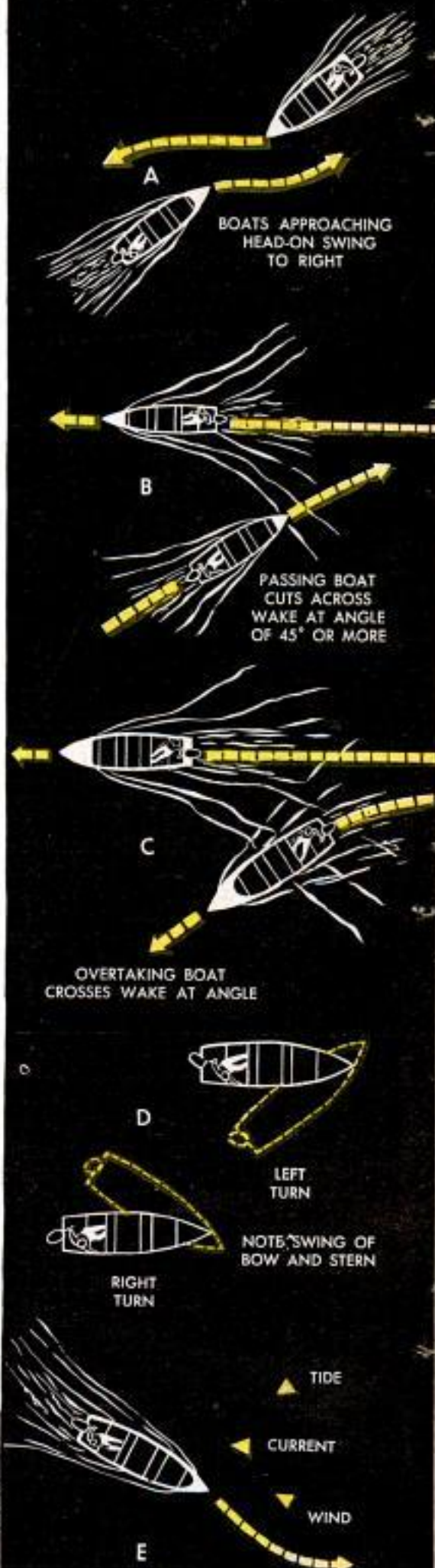



Forms for Concrete "Stones" Are Discarded Cooking Pots

Concrete "stones," which will provide protection for the lawn bordering a driveway, are easily cast by using discarded aluminum cooking pots as forms. First, hammer the bottom and sides of each pot to make it an irregular shape. Then fill pots with concrete and force a bolt or length of steel rod into the middle of the form, allowing about 4 in. to project. After the concrete has set, a few light taps on the form will cause the stone to drop out. When the stones are set along a driveway, the projecting rods or bolts are forced into the ground to anchor the stones in place.

Walter J. Swontek, Dania, Fla.

Waste Piece From Curved Cut Used as Sanding Block

After cutting a curved section from work in your shop, cover the waste portion with a strip of sandpaper and use it as a sanding block. This will result in a perfect sanding job without any danger of altering the contour of the edge to be sanded.

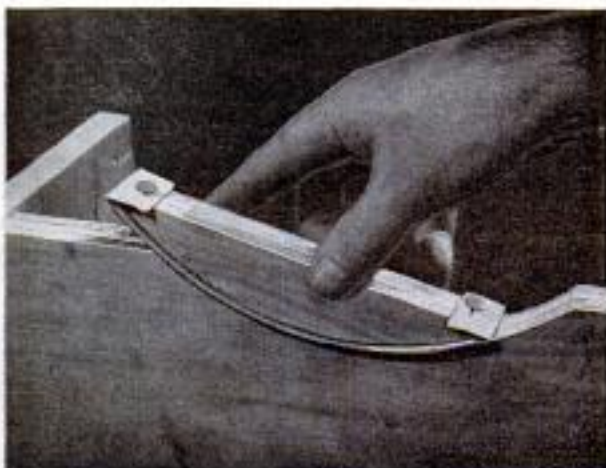

CANE-WOVEN HOT PAD

By Walter E. Burton

Offering something different in the way of a hot-dish pad, this cane-woven one will appeal to those with a flair for the unusual. It's the type of project the enterprising home craftsman will want to add to his line of gift-shop items. To help save weaving time, cane webbing which comes already woven, can be used instead of strand cane. In this case, a $\frac{3}{16}$ -in. groove is used to take a reed spline which is glued in place to anchor the webbing.

The wooden frame measures 8 in. square and is assembled from $\frac{3}{4}$ x 1-in. maple. Dowel or mortise the corners of the frame and cut a $\frac{3}{16}$ x $\frac{1}{2}$ -in. rabbet on the underside as indicated in the detail. Following the photos, drill a row of nine holes along each frame member, spacing them $\frac{3}{4}$ in. apart. You'll note that there is an additional hole at each corner, making a total of 40 holes. Finally, sand the frame, rounding the edges and corners slightly, and finish with clear lacquer.

A study of the photos on the opposite page will give you a good idea of how the weaving is done. Use regular chair-seat cane about $\frac{1}{8}$ in. wide and soak it in water for about 15 min. to make it pliable. The rabbet on the underside of the frame provides clearance for the strands. The starting and supplemental strands are anchored to the frame by knotting the ends of the cane and driving a small nail or tack through the knot. Begin weaving from left to right, using a wooden peg to keep the strand taut as the weaving progresses. Weave back and forth and, when the horizontal strands are in place, lace the vertical ones. Two layers of horizontal and vertical strands are required, and actual weaving begins with the second layer of vertical strands, weaving over and under and drawing snug. The pattern is completed by lacing diagonally, under the horizontal strands and over the vertical ones. This is done in one direction and then the other. Tension on the woven cane is relieved by re-moistening occasionally with a wet cloth. The final weaving step consists of covering the holes with a strand which is held with running loops of cane passing through the holes as shown in the detail. The end of the strand is anchored with a tack as before. Rubber-headed tacks at the corners of the frame provide nonmarring feet.

WTM '55

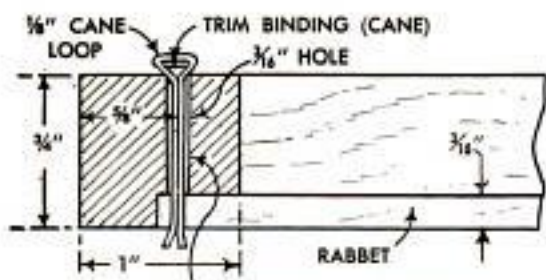

HOW HOLES ARE TRIMMED WITH CANE

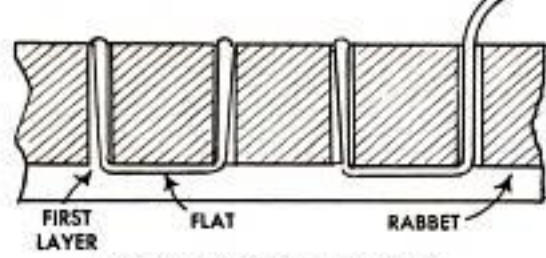

POSITION OF CANE IN HOLES



Below, router bit in drill press is quick way to run 3/16 x 1/2-in. cane rabbet around inner edge of frame on underside. Although it is optional, rabbet conceals anchored ends of strands to make neat job

Below, after first soaking cane in water for 15 min. to make it pliable, run two layers of strands, one on top of the other. Add third layer and start weaving with fourth layer, over and under the first and third



Below, fourth step is nearly completed. Watch to see that the glazed side of the cane is always up and keep work dampened with wet cloth to make weaving easier. Use wooden peg to keep strand from slipping

Below, fifth step consists of weaving diagonally across the frame, under two and over two. When this step is completed in one direction, it is repeated in the opposite direction, over two and under two as shown

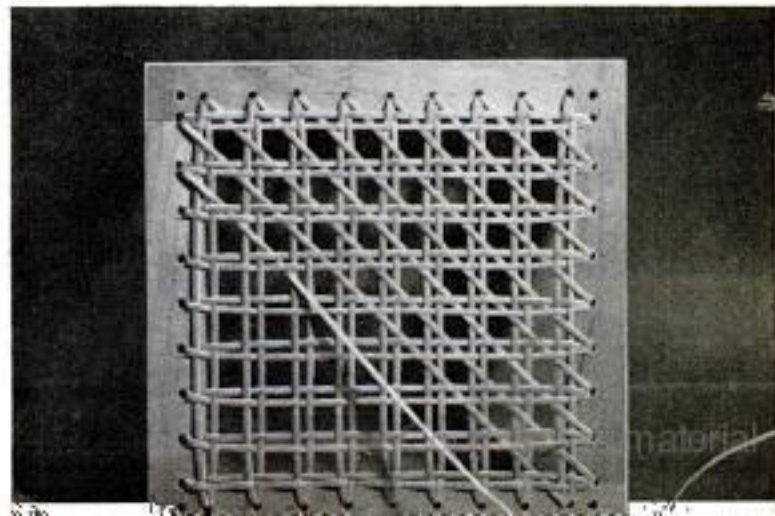
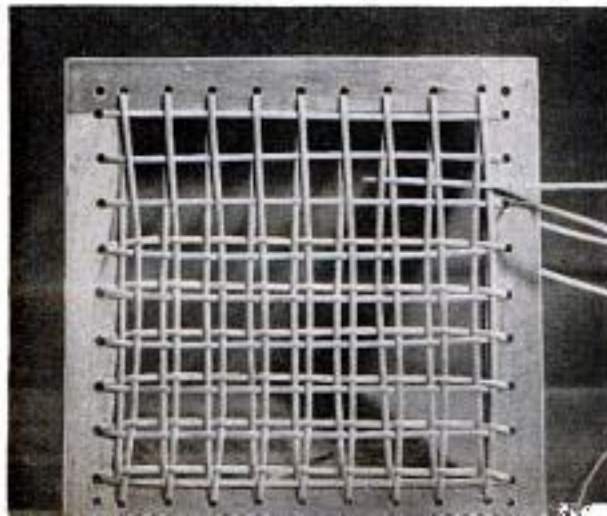



Die Made of Steel-Rule Stock Cuts Accurate Duplicates

When he had a number of accurate duplicate cuts to make in cardboard, leather, and other sheet material, one man made a die using steel-rule stock obtainable at most printers' supply houses. The steel-rule strip was cut into four equal lengths and the rough opening for the die was cut in a piece of plywood of a thickness slightly greater than half the width of the rule. The opening in the plywood was filed until the steel-rule strips fitted snugly into it, thus forming the square die. The waste piece which had been cut from the opening was then forced back in place to lock the steel-rule strips in position, and the entire assembly was backed with $\frac{1}{4}$ -in. hard-board. The material to be cut was backed with cardboard to protect the cutting edges of the die. The rule edges of the die can be removed for resharpening. In use, the two assemblies are squeezed together in a vise, or the cutter is forced into the material by hammering on it with a mallet.—Walter E. Burton, Akron, Ohio.

Prevent Spinning Lures From Kinking Fishline

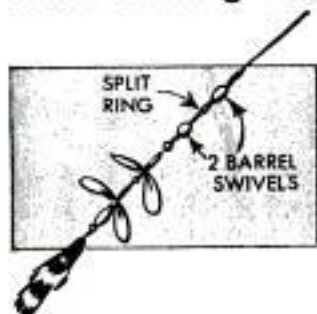

freely, the two swivels will allow the lure to spin without kinking the line.

To prevent a lure or spoon with a spinning action from twisting and kinking your fishline, attach the lure to your line as shown, using two barrel swivels connected by a split ring. By turning

Plastic Bottle Used to Spray Water on Dirty Windshield

An empty plastic deodorant bottle filled with water can be kept in the glove compartment of your car for use in cleaning the windshield. A few squeezes of the bottle puts a film of water on the windshield and the dirt can be wiped off easily. To improve the cleaning qualities, window-spray solution can be put into the bottle in place of water.

Warren Manske, Milwaukee, Wis.

Papers Held by Envelope Flap When Stapling Several Sheets

When very frequently faced with the slow job of stapling together the sheets of a large number of pamphlets and circulars, one office worker used the flap of an envelope to help maintain accurate alignment of the sheets and speed up the job. He squared up the sheets and inserted them under the loose flap of a common envelope which held them evenly while stapling together.



Small Objects "Clamped" in Clay While Soldering Joints

Small, irregularly shaped objects to be soldered can be "clamped" in a block of child's modeling clay. The clay may be shaped firmly around the objects to be held, does not conduct away the heat and is heavy enough so that it will not shift when the soldering iron is applied. Do not allow hot iron to contact clay.

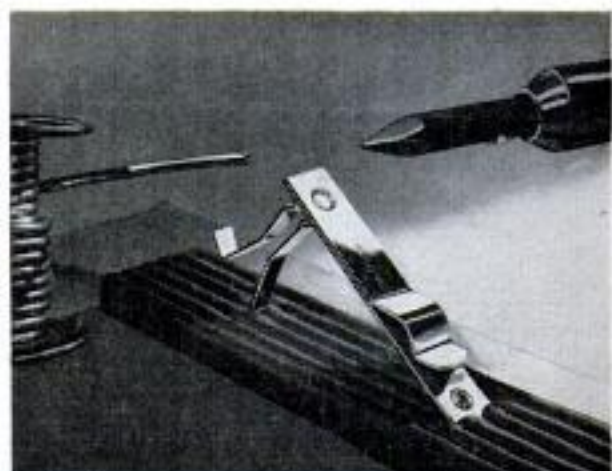

LUNCH BOX

Hooks Over Car Seat

The sometimes messy job of serving a light lunch while traveling in a car is simplified with this lunch box, which hooks over the back of the front seat. If you have small children, the box will be especially convenient. Pockets at each end hold vacuum bottles, and a roomy compartment in the center stores sandwiches and other foods. The handles swing outward to double as seat hooks. The center section is a simple plywood box, measuring 9 in. long, 8 in. high and fitted with a hinged lid. The depth is determined by the diameter of the vacuum bottles. Pockets for them are formed by bending sheet metal over the rounded endpieces and tacking to the center compartment. Then the entire unit is covered with heavy oilcloth. The handles are bent from curtain rods.

Bertram Brownold, Cedarhurst, N. Y.



Curtain-rod handles swing out to form hooks for hanging lunch box conveniently over back of car seat

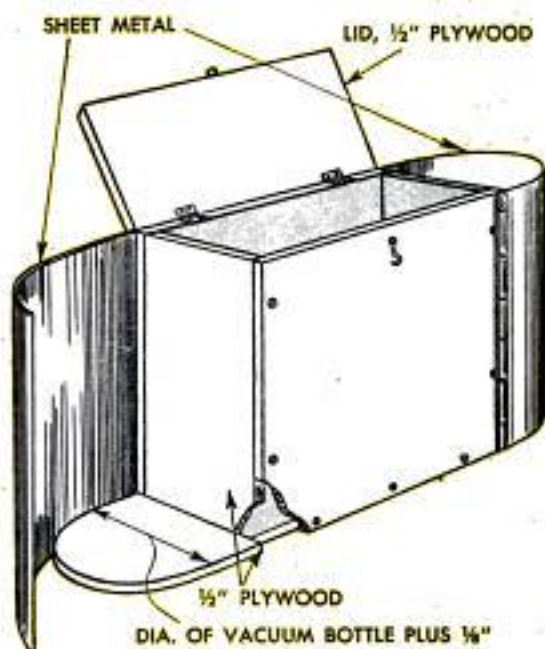

File for 35-mm. Transparencies Made From Photo-Paper Carton

This handy file for 35-mm. transparencies can be made by gluing strips of corrugated cardboard in the center and to the sides of a box of the type used as a container for 100 sheets of 4 x 5 photographic print paper. The center strip is $\frac{3}{16}$ -in. cardboard with corrugated board glued to both sides, and is glued to bottom and sides of the box. If two transparencies are placed in a slot, the file will hold 60 mounted slides.

Weighted Drapes Hang Straight

New or newly washed curtains and drapes can be made to hang properly if small weights, such as stones, are inserted in the hem and distributed where needed. After several weeks, weights may be removed and drapes will hang straight of their own accord.

E. V. Marchbank, Canton, Ohio.

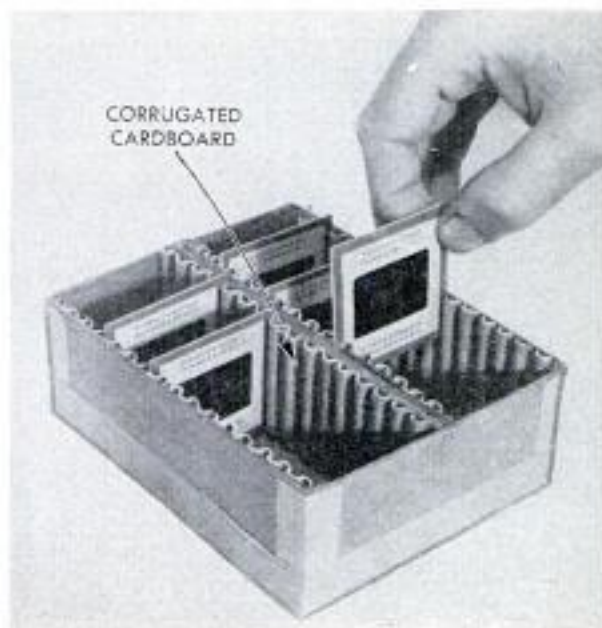

Solving Home Problems

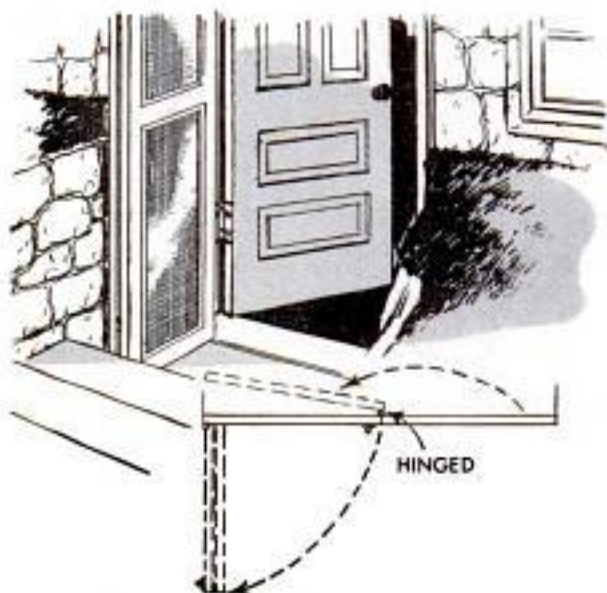

A SCREEN DOOR for the basement might be impossible because of lack of room for the door to swing unless you do as one reader did: make the door in two sections and hinge it together, so it folds to one side

INSTEAD OF DISCARDING that last bit of stick cologne when it becomes too small to handle, just wrap it in a facial tissue and carry it in a corner of your purse as a gentle but long-lasting perfume. It also may be placed in a jewelry or hosiery box



BARE WALLS in a kitchen can be relieved with a dummy window made by putting a mirror into a large picture frame, attaching a board as a sill and hanging curtains to complete the illusion

THE LETTERING on the thermostat adjustment of an electric iron can be renewed when it becomes worn and faded. Increase depth of letters with a heavy needle or awl, then fill with "gold" paint mixed to a thick consistency. Wipe surplus from surface

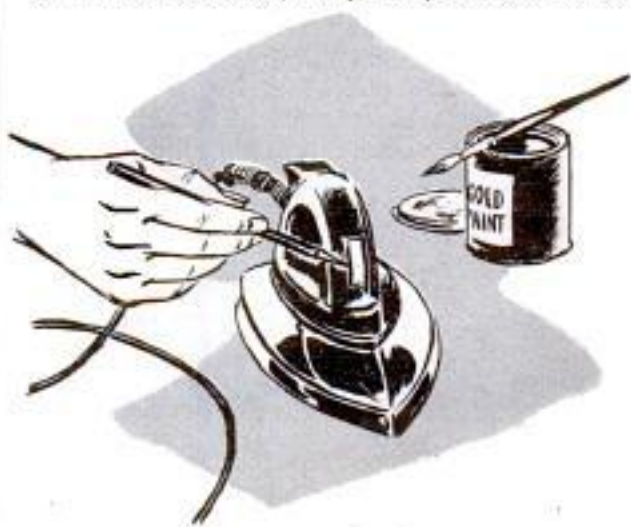



FOR CLEANING narrow-neck vases, deep bottles, inaccessible corners and other out-of-the-way places, fasten a piece of sponge to the end of a small stick or dowel of suitable length. Dipped in a detergent solution, this gadget will enable you to do the cleaning job with ease

MENDING TAPE, which is applied with a hot iron, can be cut into the shape of initials to be applied to clothing for identification purposes. The letters can be traced on the tape from magazines or newspapers, using carbon paper, and then cut out



BATHROOM MIRRORS which are subjected to an unusual amount of dampness will remain clear and unclouded much longer if a coat of clear shellac is brushed over their back surfaces. This will serve to seal out the moisture. A plastic spray also can be used



DECALS won't be hard to remove from furniture that is to be repainted if the surface is waxed before the decal is applied. Then a few wipes with a cloth dipped in hot water or gasoline removes decal easily

PAINT COLOR SAMPLES are easier to carry in your purse or pocket, to mail to a color consultant and handier to use if they are made by dabbing the paint on a scrap of cellophane taken from a cigarette pack. This type of sample makes comparisons easy



Projecting Doorknobs Replaced By Recessed Cabinet Pull



Replacing the knob on a door which is in a hall or other cramped space, with a recessed-type cabinet pull will remove the hazard of snagged coat sleeves and lost tempers. Remove the regular knob and lock and plug the holes. Using an expansive bit, drill a hole in the door to receive the metal backing plate of the cabinet pull, allowing the point of the bit to just show through the other side. Glue a wood block, larger than the hole, to the inside of the door, and drill a hole in it for the screw that holds the cabinet pull. Because the latch is removed, it is suggested that a heavy friction-type catch be used. This idea is most practical for closet doors.

Tom Riley, Portland, Ore.

Paper-and-Paraffin Starters Ideal for Outdoor Fire Use

PAPER ROLLED AND SOAKED IN PARAFFIN



A couple of these paper-and-paraffin fire starters, which are small enough to be carried in your pocket, pack or fishing box, will simplify starting campfires. Tightly roll a 2-in.-wide piece of absorbent paper, such as newsprint, into a roll about the diameter of a broomstick. Melt ordinary paraffin in a pan and drop the roll into it. When the roll is well soaked with paraffin, remove and let dry. To start a campfire, drop the

fire starter on a few sticks or pieces of bark, light it with a match and your fire is well on its way.—Russ Jenkins, Chicago.

Oil-Soaked Sand Keeps Tools Rust-Free in Damp Location

Tools kept in basements, garages, tool sheds and other locations where dampness is prevalent can be safeguarded from rust by storing them in a box of oil-soaked sand. Use a box large enough to accommodate the number of tools to be stored, fill it with clean sand and saturate the sand with motor oil. Tools are stored by inserting them with the handles exposed.

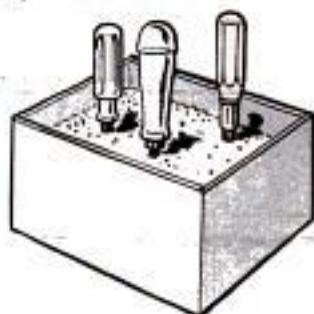

Henry A. Miller, Kent, England.

Patching Torn Window Screens

Neat emergency patches may easily be made in window screens if the hole is covered with mosquito netting, and then two or more coats of shellac are applied over it to cement it to the wire. When dry, the patch will effectively keep out all insects and save you the bother of replacing the screen wire until the screens are taken down in the fall.

Cutter and Ratchet Screwdriver Is Substitute Hand Grinder

When a power tool is not at hand for cutting and grinding, a slow but satisfactory job can be done by mounting wheels or cutters of the power type in the chuck of a ratchet spiral screwdriver. A downward thrust on the handle will revolve the cutter rapidly. Only light pressure should be used so that the cutter can be held in position without slipping.



THE HANG OF WALLPAPERING

Hanging wallpaper is easy when you know how, and new papers and pastes have made it easier

By Tom Riley

IF YOU want to give your living room a brand new mood, or provide a real lift to a tired dining room or bedroom, there's wonderful help waiting for you in the nearest wallpaper pattern book. You'll be pleasantly surprised at the grand selection being shown in wallpaper stores these days—in almost any color or pattern you can imagine, from the very traditional to the ultramodern, for every room in the house. And, what is more important, the art of wallpapering has been brought into the "do-it-yourself" field with the introduction of new papers and pastes, and new methods. Much of the muss and fuss of papering has been eliminated so that a good job can be done by almost anyone.

Selecting the paper: The heavier rough papers are an especially



One innovation in the wallpaper field which simplifies paper hanging for the homeowner is a new paste-impregnated paper that is electronically pretrimmed. The only tools required to hang this paper are a sponge, scissors, yardstick and plumb bob





Pictures at left show two methods of trimming wallpaper prior to applying paste. Careful cutting with scissors is satisfactory, though the use of a straightedge and roller will give a better edge. If using cutting table, apply paste before trimming



Above, curl is taken out of paper by drawing it, print side up, over the edge of a table. At left, paste is applied to top half and paper is folded to center. Then the bottom half is pasted and folded. Folding keeps the paste moist



good bet for the amateur. They are easier to join, tear the least when handled and cover rough plaster, plywood and old wallpaper without blemishes. The standard wallpapers vary considerably in price. When choosing one, select only high-grade paper. Economy at this point may prove expensive in the long run. Also available are washable types of standard paper, which are easy to keep clean and new looking. Fabric wallpapers, consisting of a decorative cloth or grass mat glued to a paper backing, are popular today but are quite expensive. You can economize here by using imitation "grass cloths," which are heavy standard papers that are difficult to tell from the fabric type. Cellulose-plastic papers are among the newest additions to wall-papering. Though they have the appearance of standard papers, they can be scrubbed the same as an enameled wall. Standard wallpaper, too, can be made fully washable by an application of one of the new plastic "lacquers," which are brushed on the paper after it is hung.

Ready-pasted and trimmed papers: Designed especially for the homeowner to apply himself, papers with the adhesive already on the back and pre-





Seams are rolled after the paste has set. Usually by the time 4 or 5 lengths have been hung the paste will have set properly for rolling. Keep the seam roller wiped clean to prevent paste stains on paper

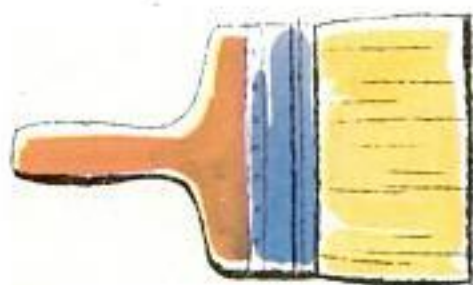

Roller cutter is used to trim paper along moldings and baseboard after paper is smoothed on with brush. Edges around door and window frames also are trimmed with roller cutter. Waste should be kept away from paper on the wall



trimmed by electronically-guided machine cutters have made their appearance. The newest of these papers is "Quick," manufactured by the Birge Co. of Buffalo, N. Y. The paper is washable, has the adhesive impregnated right in it and comes rolled with the pattern on the outside. To apply this paper, the wall is prepared by dusting and removing any loose ends of the old paper. Then, for a smoother job, the old seams are sanded flush. If the paper is to be put on a new wall, or a wall which is painted with a high-gloss enamel, a glue sizing should be put on the wall first. Even on walls which are covered with flat and rubber-base paints, it is always best to size before applying paper. In addition to the paper, which comes in standard-sized rolls, you need only a pair of scissors, a cellulose sponge and a yardstick. With every roomlot of the paper, a cardboard trough is provided to hold the water used in wetting the adhesive.

The trough, half-filled with water, is placed on the floor along the baseboard. The first strip of dry paper is cut to length, then allowed to roll naturally. Immerse the roll in the water for 30 sec., then grasp the top end of the strip and pull it out so that the roll remains submerged to permit all of the adhesive to be wet. If necessary for convenient handling, fold the adhesive-coated back against itself, just as in conventional paper hanging. Apply the adhesive side to the wall in much the same way as you would stick a postage stamp to an envelope. Since the adhesive remains wet

and workable for better than 15 min., there is no need to hurry. Slide the strip into proper position in respect to a plumbed guide line. Use the sponge with only normal pressure to smooth the material and force out the air bubbles. Only the large bubbles need concern you. The small ones which the sponge won't move will disappear as the paper dries. The paper is pre-trimmed, so neat butt seams are easy to make. Where complicated seams must be made, simply overlap the two thicknesses, cut them as required, remove the scrap and press the remaining material into place. The adhesive is nonstaining and can be wiped off the surface of the paper with a sponge or cloth at any time. If the entire room cannot be finished at one time, the job can be done piecemeal.

Tools: For standard wallpaper application, complete kits can be rented in many parts of the country at nominal cost from wallpaper dealers. Such a full set of tools includes a seam roller, shears, yardstick, paste brush, smoother brush, trimming knife, scraper, 7-ft. straightedge and a cutting table. For a small papering job, you can probably find enough tools around the house to do an adequate job. For the seam roller, substitute a clean wooden-wheeled furniture caster. Any household scissors



Left, new type of paste now on market is applied to wall instead of paper. Paper is unrolled on wall, eliminating cutting



Photo courtesy Wm. Barr and Co.



Garden sprayer can be used to apply water or wallpaper-removing solution when taking off old paper. Secret of easy removal is thorough soaking of wall before scraping

will do for the shears, and the paste brush can be any large brush on hand. For the smoother, use a soft sponge. A good sharp knife or razor blade will serve as a cutter, and a trued-up 7-ft. board can be used as the straightedge. You will also need a plumb bob to start the job and some type of worktable on which to do the cutting.

Wall preparation: Getting ready is half the battle. If the old wallpaper is well bonded to the wall, there is no need to remove it. Simply smooth any lapped joints with sandpaper and start the new paper so that the new joints will not fall directly over the old. Do not size the old paper. If there is any indication of a poor wall bond, completely remove the old paper. The common way to do this is to soak the paper, using a large brush or a paint roller dipped in hot water. The spray attachment on your vacuum cleaner can be used to wet the old paper. Go entirely around the room, wetting the paper thoroughly. When the last wall is soaked, the first paper should be loose enough to remove with the scraper. Adding a little baking soda, borax or ammonia to the water will aid in softening the paste. Or better yet, use one of the new wallpaper-removing solutions now available at your paint dealer. In some localities, equipment for steaming off the paper can be rented. When all of the paper has been removed, wash down the walls with a sponge and let dry. Holes and cracks in the plaster

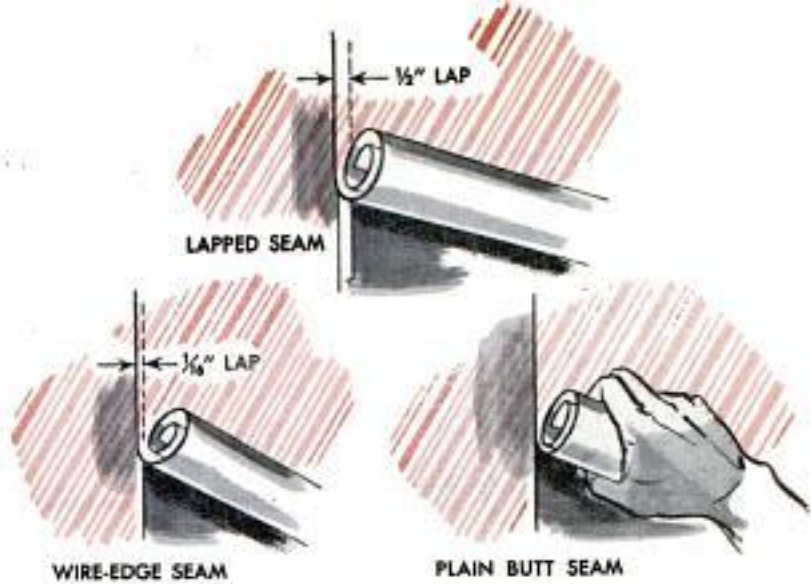
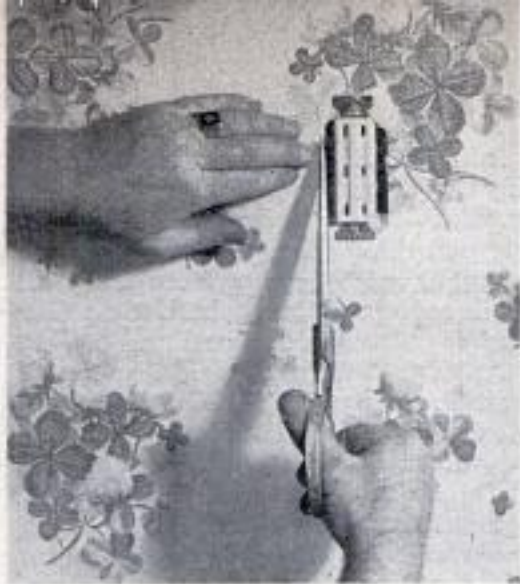

Paper is pasted directly over switches and wall outlets after cover plates are removed. When paper is completely dry, it is trimmed away with scissors

The lapped seam is the easiest to make since only one edge need be trimmed. Wire-edge seam looks better but is harder to match. Butt seam is smoothest

are filled smoothly with patching plaster. Very porous plaster, new plaster, plaster-board and plywood walls should be glue-sized. The size is mixed with hot water and applied while still warm, using a large brush to apply it quickly before it jells. Let the size dry thoroughly before papering, or it may stain through. Walls which have been painted should be washed before sizing, and calcimine or whitewash should be thoroughly removed with hot water. On rough walls, such as sand-plaster finishes, apply a lining paper or lining felt first. The liner also should be used on plywood to hide the grain if a thin paper is to be used. Wallpaper may serve as a liner if the pattern side is placed against the wall.

to the first and put on in the same manner.

Estimating rolls: Because some rolls of paper vary in size, it is best to have your wallpaper dealer figure the number of rolls needed. Give him the length, width and height of the room, plus the number of doors and windows. Or you can estimate the number of single rolls (the standard 8-yd. roll) by using the table on this page. Subtract one roll of paper for each two doors and window openings.

Cutting to length: Before cutting the paper, see that all rolls are from the same factory "run" number, for the best match. Examine the pattern closely so you can cut it without waste. Usually there will be "join" marks on the edges of untrimmed papers. There are two types of wallpaper patterns, the straight and the drop. With the straight pattern, all lengths of paper are cut on the marks to match. With drop patterns, the strips will match only if you drop each successive strip half the pattern design. Thus, if the pattern repeats itself every 18 in., the next length of paper must be lowered 9 in. to match. In using a drop pattern, cut from two rolls for economy, one on the marks and one halfway between the marks. Before cutting regular paper, take the curl out of it by sliding it, print side up, over the edge of a table.

Paste: Regular wallpaper paste can be purchased ready-mixed, requiring only the addition of water according to the directions. Use a small paddle to mix the paste. For lightweight papers, make the paste thin, while for heavy papers, keep it quite stiff. The new plasticized pastes, which come ready to use, are a boon to the beginner because they smooth out well and will not stain the paper. The latest innovation in pastes is one which is applied to the wall instead of to the paper. Made by Easy Hang Adhesives, Inc., of Aurora, Ill., this new paste eliminates precutting of the paper. After the paste is applied to the wall, the end of the paper is pressed in place at the top of the wall, allowed to unroll to the bottom, and cut off at the baseboard after brushing down. The next strip is matched

Pasting and trimming: If you trim the edges with scissors, do it before pasting, using a yardstick to draw a light trim line. If trimming with a knife and straightedge or on a cutting table, trim after pasting, so as not to get paste over the finish edges. The trimming also depends on the type of joint you use—lap, wire or butt. The lapped joint is the simplest and requires trimming

ROLLS OF PAPER FOR ROOMS

Lineal ft. of walls	Height of room				Rolls for ceiling
	8'	9'	10'	11'	
48	12	13	15	16	2
52	13	15	16	18	3
56	14	16	17	19	3
60	15	17	19	20	3
64	16	18	20	22	3
68	17	19	21	23	3
72	18	20	22	24	4
76	19	21	23	26	4
80	20	22	25	27	4
84	21	23	26	28	4
88	22	24	27	30	4
92	23	26	28	31	8
96	24	27	30	32	10
100	25	28	31	34	13
104	26	29	32	35	14

Single rolls



When papering ceiling, the paper is carried loosely folded back and forth across a stick or odd roll of paper. It unfolds easily as you cross the room

only one edge. For the wire joint, both edges are trimmed, but do not need to be perfectly true because they lap about $\frac{1}{8}$ in., leaving less bulge than the lapped joint. The butt joint is the very best but requires perfectly true edges to butt together snugly. The ready-trimmed paper makes excellent butt joints.

To apply paste, lay a cut length of paper upside down on the table and spread the paste evenly on the upper half. Then, without creasing, fold the end of the pasted half to the center. Paste the other half and repeat the fold to the center. This keeps the paste clean and prevents drying out. If the edges are to be trimmed, keep the selvage perfectly even when folding. Lay the straightedge on the folded paper and trim. Work fast with thin papers or the paper will become too wet and may tear. Avoid pasting or hanging in a drafty room because fast drying may crack the paper. Don't let paste dry on the table—wipe it off after each day's use.

Hanging the paper: The trick of papering is to hang the first length plumb. Start on the obscure side of a door or window, because the last length is difficult to match exactly against the first. If the door or window is not plumb, run a plumb line from the top of the wall one length of paper away from the frame. Hang the first length to this line, trimming to fit the frame. When hanging paper, carry the pasted lengths folded to the wall. Unfold the top half by lifting the top high and letting it unfold slowly of its own weight. Press the top corners in place with your fingers, leaving an inch or so of paper above any top mold-

ing. Smooth out the paper with the brush, crowding the upper end tight against the molding. Unfold the bottom half and repeat the smoothing. If a wrinkle appears, pull the paper gently away from the wall and smooth back in place again. Use a roller cutter to trim at the baseboard and ceiling molding. Before the paste dries, wipe off any excess on the woodwork. Cut the paper $\frac{1}{2}$ in. wider than needed around doors and windows and crowd into place against the wood, then trim with the roller cutter. For corners, measure from the last length hung to the corner, and cut a strip $\frac{1}{2}$ in. wider than this measurement. Hang this strip, crowding the extra $\frac{1}{2}$ in. around the corner with the smoother. Then hang the remaining part of the cut length as the first length on the adjoining wall, using a butt joint, thus matching the pattern. Use a chalked plumb line again to hang this first strip on the next wall. Always have clean damp cloths available to remove any paste marks on the paper. Roll down the seams of the paper after 4 or 5 strips have been hung. Keep the seam roller wiped clean. At electric outlets and switches, remove the cover plates and paper over the openings. Then trim with a scissors when fully dry. The border at the ceiling is hung last, starting in an obscure corner.

Ceilings: Ceilings today are often painted, but can be attractively papered with less difficulty than you might imagine. As with the wall, the secret of overhead paper hanging is in starting out correctly. A ceiling is always hung before the walls, and is started by snapping a chalk line about 16 in. out from the wall and hanging to this line, carrying the paper down the wall about $\frac{1}{2}$ in. Using butt joints, the paper can go either across the room (shorter and simpler) or lengthwise (fewer seams). But with lap or wire joints, it is important to start along the lighted side of the room so that shadows will not be cast from the seams, making them noticeable. Carry the paper to the ceiling folded loosely back and forth over a stick or odd roll of wallpaper. Press the end in place. Then, as you continue across the room, the paper will unfold as you smooth it in place. Ceiling seams are rolled down firmly, as on the walls.

★ ★ ★

Sharpen Scissors on Circular Saw

To grind scissors on a circular saw, place a grinding wheel or disk faced with emery paper on the arbor. Tilt the arbor or the saw table about 3 deg. and grind the scissors on the right side of the wheel. A piece of plywood can be clamped to the saw table to act as a guide.

Rodney E. Bellinger, Binghamton, N. Y.

W T M '55

Flashing Grade-Crossing Signals For Toy Trains

A grade-crossing warning buzzer and flashing red neon light will add much to the realism of any model railroad layout. As the train approaches the crossing, it operates a pressure switch under the track which starts the buzzer and light. Just like the real thing, the warning signals continue until the train has passed the crossing. Most model trains run from a transformer which supplies a.c. current, so it is necessary to wire a selenium rectifier into the circuit to change this to d.c. The rectifier used is a single-unit bridge type. The .01 mfd. capacitor has been found to be the most satisfactory. If the back electrode in the neon bulb lights, merely reverse the leads to cause the front electrode to glow. The bulb is a NE 48 neon

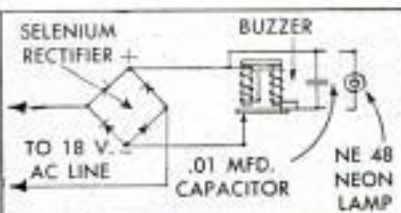

lamp. A buzzer is preferred to a bell because the louder sound of the latter will prove nerve-wracking in a short time.
George P. Pearce, Albuquerque, N. M.

Wagon-Wheel Lawn Bench Adds Beauty to Yard



The decorative value of old wagon wheels finds another application in this unusual lawn bench. The main frame of the bench is made from the front wheels and axle of a wagon. The uprights at the back of the seat and the angular braces extending to the ground are 2 x 4s, while the seat and back are 1-in. lumber. To prevent the uprights from sinking into soft ground, a 1/2 x 4-in. crosspiece can be nailed across the bottom between the uprights and the angular braces. To finish the bench, paint it white and trim such parts as the wheel rims, axle and hub bands in a dark color.
Kenneth Hadenfeldt, Storm Lake, Iowa.

Transfer Pictures Decorate Photograph

A novel way to decorate a photograph is to use colored transfer pictures, of the kind used for Easter-egg decoration. A sheet of such transfer pictures is usually included in a ten-cent package of Easter-egg dye and may be bought separately in small booklets at school-supply stores. The pictures are easily transferred to the photograph print by laying the transfer in place and dabbing the back with a damp cloth. The sheets of pictures include humorous drawings that will amuse adults, while others, including Mother-Goose and Walt-Disney-type sketches, will please children.



Screen-Wire Pad Removes Labels On Bottles and Jars



Difficult to do with the finer grades of steel wool used in scouring pads, labels can be removed quickly from bottles and jars with a piece of screen wire. The screen is shaped into a pad, with the ends of the wire folded under to prevent cutting the fingers. When the paper has been removed, regular scouring pads will remove any adhesive that may remain.

Hook Taken From Fish's Mouth With Aid of Vegetable Tongs

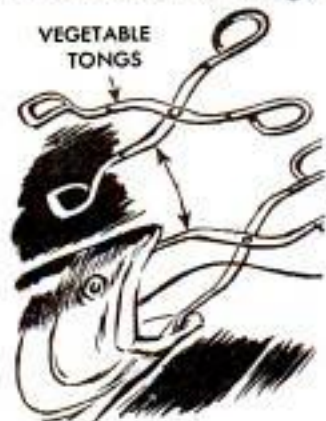

A pair of vegetable tongs, such as used by cooks for lifting hot vegetables from their cooking containers, can be used by fishermen as a handy disgorging tool when removing hooks from the mouths of fish. The closed tongs are forced into the fish's mouth and

then opened, thus forcing open the jaws. The hook then can be removed easily and without danger of being injured. The vegetable tongs can be purchased at most five-and-ten-cent stores.

Tracing Car Serial Number

To make a tracing of a car's serial and engine numbers, which many states require when a title is being transferred from one owner to another, use a small piece of aluminum foil taken from a gum wrapper. The foil is placed over the numbers and

stretched tightly between the thumb and forefinger of one hand, while the thumb of the other hand is used to rub the area over the numbers until they become visible as impressions in the metal foil.

Mrs. J. A. Sweitzer, Armbrust, Pa.

Buggy Wheel Is Removable For Mowing Lawn

The difficulty of mowing around old wagon and buggy wheels, set permanently in a lawn, can be avoided by making the wheels removable. To do this, weld a 2-in. pipe coupling to the steel tire of the wheel. Set a length of 2-in. pipe in concrete, so that its top end is just below ground level. When the lawn is mowed, a few turns unscrews the wheel from the pipe base and the mower can run over the pipe without damage.

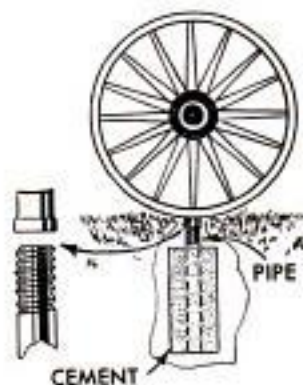

Orlin Jirka, Ralston, Neb.

Wire-Solder Dispenser

A discarded metal typewriter-ribbon box is used by one repairman as a compact container to carry a supply of both rosin and acid-core solder in his repair kit. Two $\frac{1}{8}$ in. holes are drilled through the sides of both cover and bottom. The hole in the bottom edge of the cover and in the top edge of the box are then slotted. One length of solder is coiled inside the box, the other in the cover, and the ends passed through the holes. The slots allow the cover and box to clear the projecting ends of the solder when the box is assembled. The type of solder is marked on the can.

John J. Rea, Urbana, Ill.

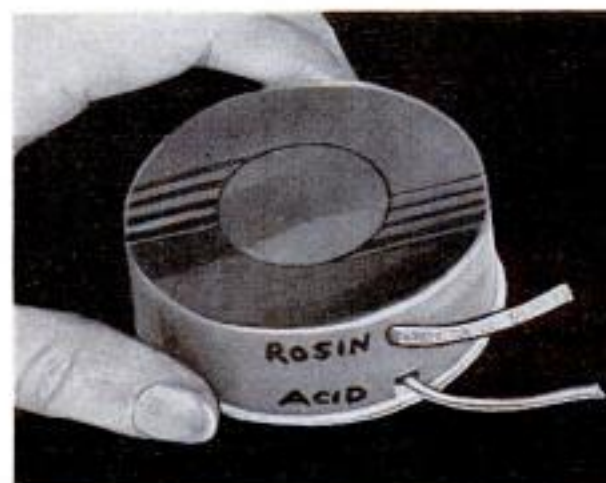

THREE-TIERED PLANT HOLDER

Three metal funnels of graduated diameters, a common pie pan, plus two dowel pegs, are all you need to make this attractive tiered planter. The cut-away detail shows how the pegs are used to hold the two top funnels vertically, while the photo below shows how the spout of the bottom funnel is slit and bent outward to form tabs for soldering to the pie pan. The whittled ends of the pegs are driven snugly into the funnel spouts, letting the one in the top funnel extend and cutting off the peg in the bottom funnel flush with the tabs. The peg in the top funnel is wedged in the second funnel and then waterproof wood putty is packed around the wooden pegs to seal spouts

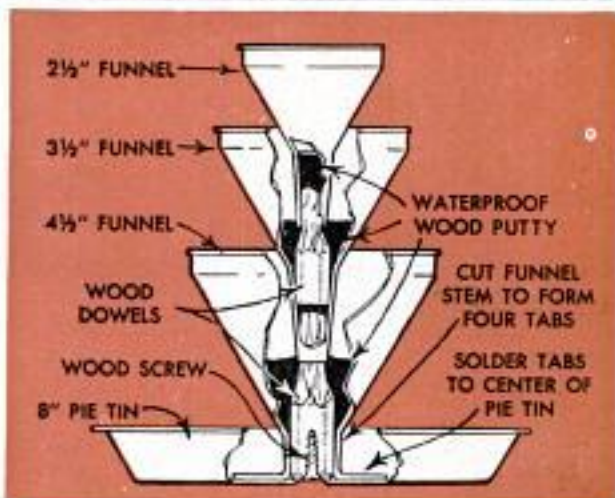
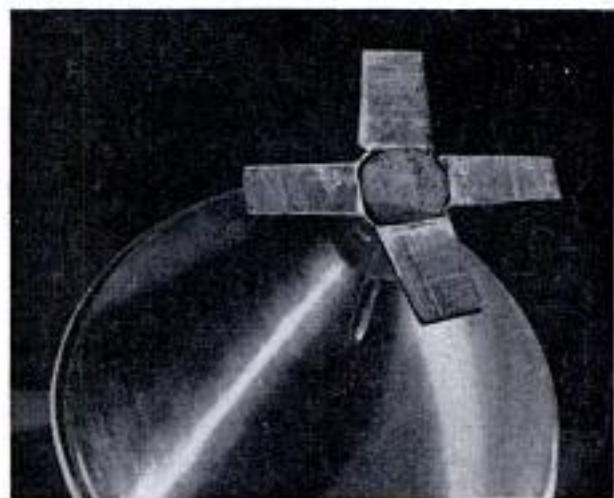

Jig Assures Accurate Sanding of Miter Cuts on Molding

After sawing miters in picture-frame and other small molding, it is often necessary to sand the cut to make a good fit. This hardwood jig permits sanding perfect joints by rubbing a block wrapped with sandpaper over the mitered end of the molding which projects through an opening in the jig. The base of the jig is cut to 45 deg. on the end that joins the sanding face and the slot in the face is cut to the same angle. A guide block for the work is fastened to the base at right angles to the sanding face. The jig is assembled with glue and wood screws for rigidity. If the jig is used often, the sanding face should be covered with light sheet metal.

Donald Zuerl, Fulton, Mo.

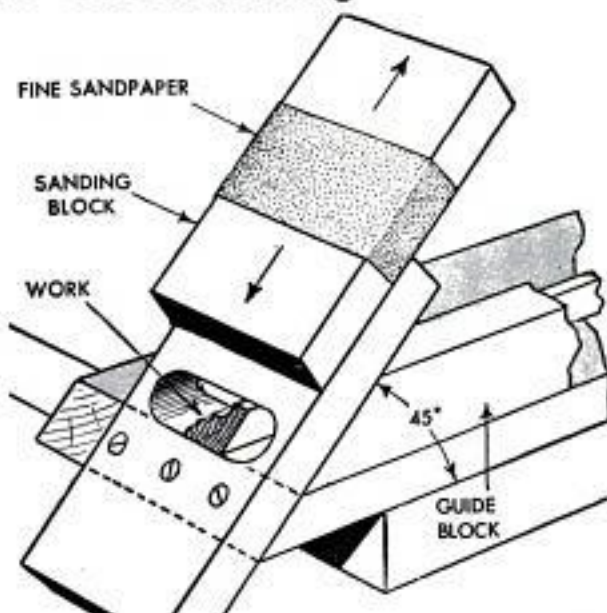

☛ To remove rust from cake tins, scour with a raw potato and powdered cleanser.

PLAN of the MONTH...

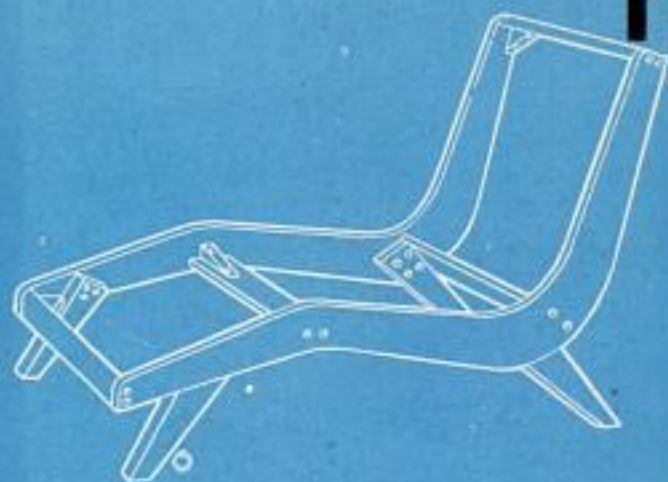

RELAXING CONTOUR design of this modern chaise longue will make it one of the most popular pieces of furniture in the house. Note from illustration that the four legs are the only exposed wooden parts of the frame and these should be of a hardwood such as oak, walnut or cherry. Frame is laid out full-size on heavy paper, using squared pattern below, and pieces for the side rails are half-lapped and glued. After side rails are band-sawed, frame is assembled with dowels or screws and glue. Then, sagless-spring clips are nailed to top edges of side rails, locating first pair $2\frac{1}{4}$ in. from the outside of the front rail and spacing remaining clips $4\frac{1}{2}$ in. on centers. Sagless springs are fastened to the clips and helical springs are added, after which springs are covered with burlap. Foam-rubber or rubberized-hair pad is applied to burlap, pad being cut 1 in. wider and 2 in. longer than frame. Next, cotton padding is added; then muslin cover and fabric cover. Back of chaise longue is covered with burlap, thin cotton layer and fabric. Underside is covered with cambric

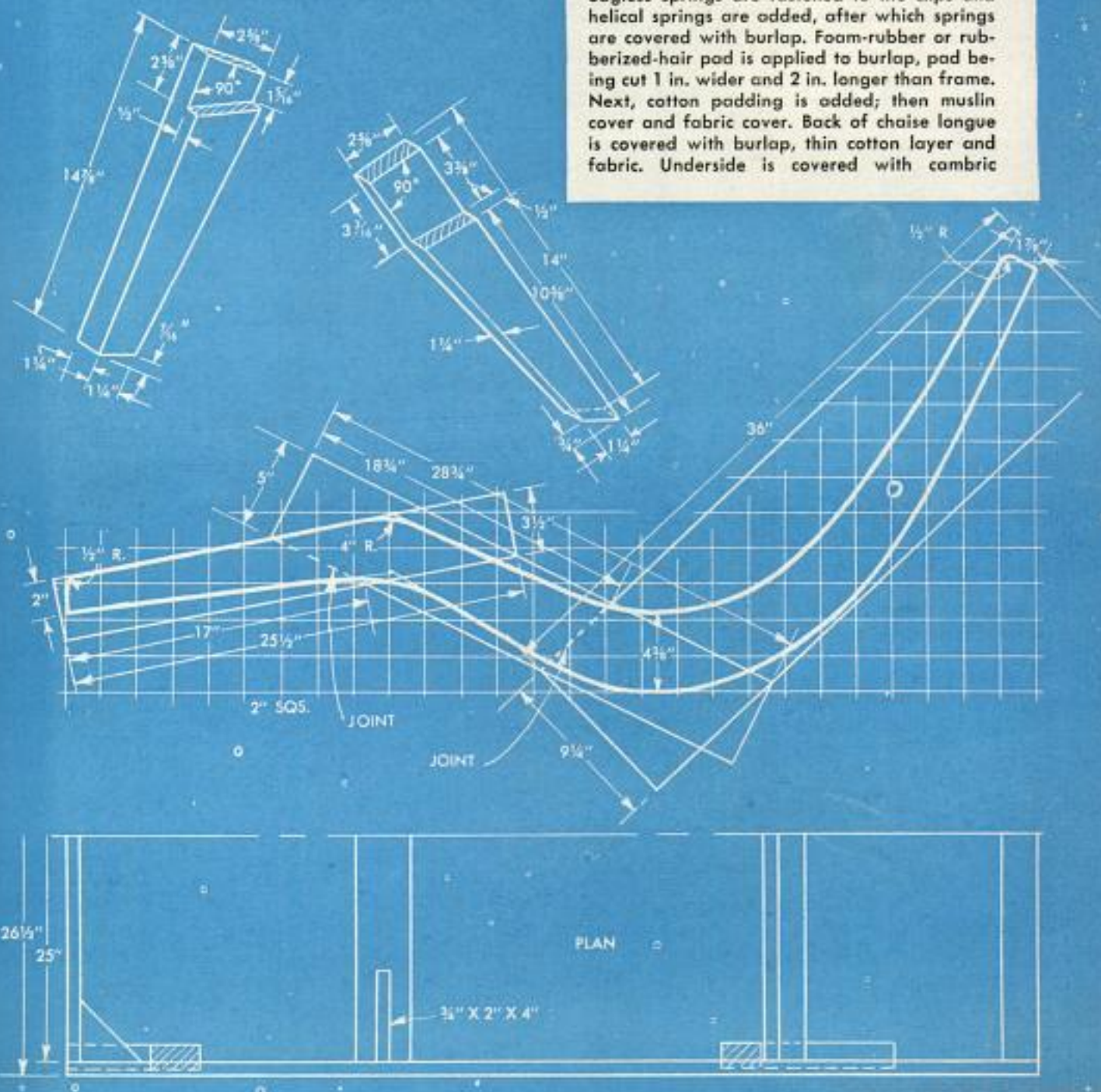

W T M '55
Chaise Longue
Modern Furniture



MATERIAL LIST

Cabinet Wood

2 pcs.—1¼" x 2¾" x 14⅞"—Front legs

2 pcs.—1¼" x 2¾" x 14"—Back legs

Soft Maple, Poplar or Gum

2 pcs.—¾" x 3½" x 25½"—Front side rails

2 pcs.—¾" x 5" x 28¾"—Center side rails

2 pcs.—¾" x 9¼" x 36"—Back side rails

2 pcs.—¾" x 17½" x 25"—Front and top rails

2 pcs.—¾" x 3" x 25"—Center crossrails

Miscellaneous

14—8-ga. sagless springs, 24" long

28—Sagless-spring clips

45—2" Seat helical springs

1 pc.—1½" x 28½" x 66" Corded foam rubber or rubberized hair, medium density

3½ yds.—Upholsterer's cotton

3 yds.—Burlap

3½ yds.—54" Fabric cover

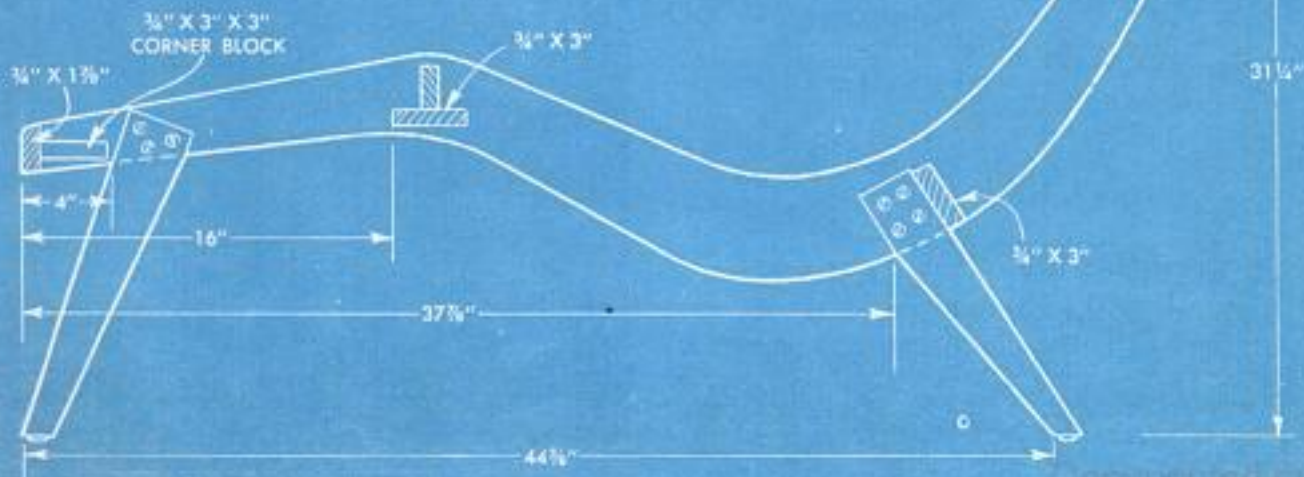
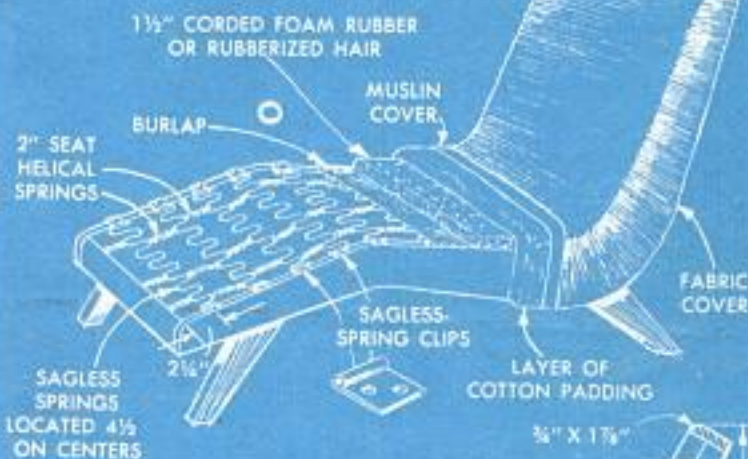

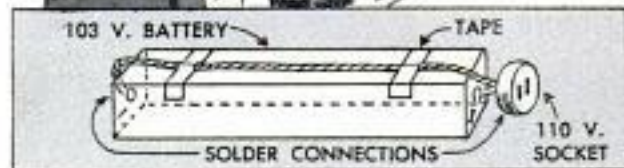

Power for Electric Shaver Supplied by Dry-Cell Battery

You can use your electric shaver no matter how far your camping trips take you from electric power if you carry this dry-cell power pack. The dry-cell battery may be one of several types which develop from 90 to 110 volts. Used in portable radios, the batteries are about 1-ft. long and 1-in. square. A 110-volt socket is wired to the battery, as shown in the detail, providing a means of connecting the shaver. With intermittent service, as in supplying current for a daily shave, the battery will last through a two weeks' vacation.

John W. Sherman, Mountain View, Calif.

Matchbook Cover Holds Flies In Sportsman's Hatband



To carry dry flies and fishhooks where they are easy to reach when he needs them, one sportsman presses them into corks which he has glued to the outside of matchbook covers. The covers, in turn, are inserted under the band of his hat, as shown. A number of flies may be kept at hand in this way.

Waterproof Your Hunting Boots

Hunting boots can be given a longer life and be made waterproof if they are soaked in a preparation consisting of mutton tallow, 5 parts; beeswax, 4 parts; and rosin, 2 parts. Heat and blend this mixture in a

shallow pan large enough to accommodate the boots and immerse the soles in it while the preparation is warm. Soak until the leather is thoroughly impregnated.

E. Dzus, Prince Albert, Sask., Can.

Rubber Ball on Fishing Rod Lessens Hand Fatigue

A child's rubber ball can be used to greatly lessen hand fatigue when holding a fishing rod for long periods of trolling and reeling. Using an ice pick or narrow-bladed knife, cut a hole in a solid, sponge-rubber ball. Make the hole just big enough to slide the ball snugly onto the handle of the rod at the point where it is usually gripped. Each time it is used it is adjusted to the most comfortable position.—L. Werner, Cleveland, Ohio.



Reflector Surfaces Renewed With Reflective Beads

When the reflector on a floodlight, auto headlight or photoflash gun has become so dulled that it is no longer effective, it can be restored to full usefulness by applying a coating of reflective glass beads. Available at art-supply shops, the beads are of the type used in making reflective highway signs. To refinish the reflector surface, brush on a coat of aluminum paint. Allow the paint to set until it becomes tacky, then flow the beads over the surface. The beads will adhere to the paint, making a smooth, even coating. In some cases this refinished surface will reflect more light than the original.



NEW FACES For OLD CEILINGS

By James R. Ward

LIKE CEILINGS in many older homes, the plastered ceiling in one of our bedrooms had cracked badly and was loosening from the wooden lath in a few places. This condition necessitated a new ceiling. However, we wished to avoid removal of the old ceiling if possible as this would reduce the cost, and the resultant plaster dust would infiltrate the entire house.

After checking with informed sources, we learned that we could plaster right over the old ceiling by using gypsum lath as a base for the new plaster. Since our old plaster was still adhering to the lath fairly well, we could nail the gypsum lath through the old plaster and into the ceiling joists to hold it securely.

Gypsum lath is applied to ceiling over old plaster. Nails are driven into joists at 4-in. intervals, lath-section ends being butted directly over joists

Joists spaced 16 in. on centers are easy to locate, but in older homes joists may be spaced irregularly. Here, holes must be made in ceiling to locate them



Base-coat plaster comes packaged with aggregate ready-mixed, requiring only addition of water. Reduces chances of error





Original ceiling is completely covered with gypsum lath and ready for new plaster. Only a 1/2-in.-thick layer of plaster is required to cover the lath base



Old plaster has been removed from cracked area at corner of room. Expanded metal lath is nailed in corner and area is replastered along with ceiling

On ceilings where the plaster keys between the wooden lath have been sheared off so that the plaster sags badly, furring strips should be used to provide a good nailing surface for the lath. In that event the old plaster should first be removed and the furring strips nailed to the joists, spacing them 16 in. on centers. Use 8d common wire nails for this job. If the plaster is not removed, as in our case, the nails should be long enough to reach through the plaster and penetrate the joists approximately 1 1/2 in.

Gypsum lath is easy to apply and goes up fast, thus saving labor costs. It provides a level, uniform surface for plastering and, unlike many types of lath, requires only a 1/2-in. thickness of plaster over it. This combination provides unusual fire resistance because the lath as well as the plaster is a protection against fire.

When nailing the lath, apply the sheets with the long dimensions at right angles to the joists. All lath ends must have bearing on wooden framing, headers or nailing blocks, and must be nailed securely. Nails should be driven so the heads are just below the paper surface without actually breaking the paper.

We used ready-mixed, light aggregate gypsum plaster for the base coat. This new packaged plaster requires only the addition of water. It is light and easy to handle, and puts less load on the joists, which is important when applying a new ceiling over an old one. Also, it avoids the common hazard of bad sand, and over-sanding is automatically avoided.

The base coat may be applied in one coat, thus saving time and labor costs, and permitting quick use of the room.

In the finishing operation on the base coat, two tools are used generally, a rod and darby. The rod is a long straightedge used to level out the surface and remove



Plasterer uses rod (straightedge) to level surface and remove excess. Final leveling is done with darby (long float) which also produces roughened surface

excess material. A darby is wood 1/2 in. thick, 4 in. wide and 4 ft. long. It is used for the final beveling of bumps and hollows.

This coat may be applied 24 hrs. after the base coat. A ready-mixed gypsum trowel finish was selected for the finish coat. It produces an extremely hard finish that can be decorated just as soon as it dries. Applied to a thickness of 1/16 to 1/8 in., the finish coat should be troweled to a blemish-free surface.

Besides applying a new ceiling, it was necessary to repair a bad corner crack. To do this, the loose plaster was removed down to the lath and cut back from the corner 2 or 3 in. on both sides. Then, a strip of metal lath was bent to fit the corner and nailed to the corner stud and the masonry wall. After wetting down the exposed wooden lath and old plaster edge, the corner was plastered in the same way as the ceiling. ★ ★ ★



Photo above shows base coat of lightweight-aggregate plaster being applied. Ready-mixed avoids common problems of using bad sand or oversanding



Last of base coat is being troweled on ceiling. Note above how plaster is troweled toward center of room. Light weight of ready-mixed plaster makes job easy



Break in wall is repaired same as ceiling, leveling with float. Roughened surface on plaster formed by float or darby is needed for finish-coat adhesion



Finish coat can be applied 24 hrs. after base coat. Photo above shows start of finish-coat application, beginning at side of room and working toward center

Ready-mixed plaster is applied in thickness of 1/16 to 1/8 in. and good workability permits long, sweeping strokes with trowel, as shown in the photo below

Finish coat is applied to break in room corner, below. Ready-mixed plaster may be decorated as soon as dry—in most cases, two days after application



Flowerpots on Wagon Wheel Increase Its Useful Beauty

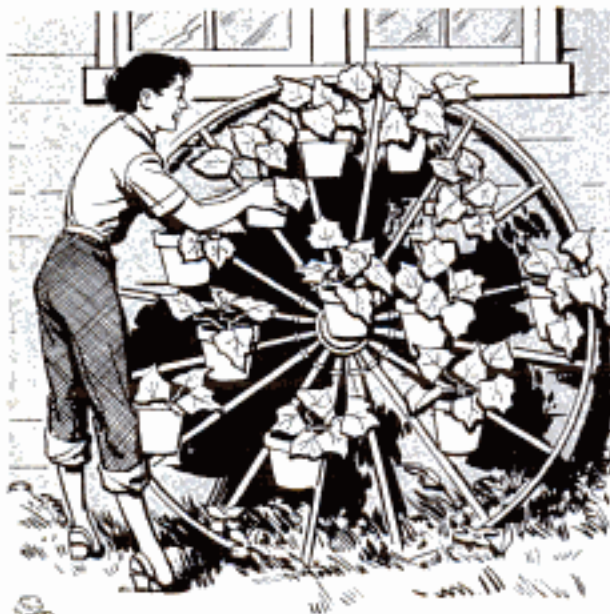

An old wagon wheel used as a yard ornament will become even more decorative and useful if flowerpots containing various kinds of flowers are wired to the wheel. Because the pots are up off the ground they are more easily tended and kept free of weeds. When cold weather approaches, it is a simple matter to remove the pots from the wheel and take them indoors.

L. H. Houck, Jefferson City, Mo.

Snag Hook Catches Nibblers

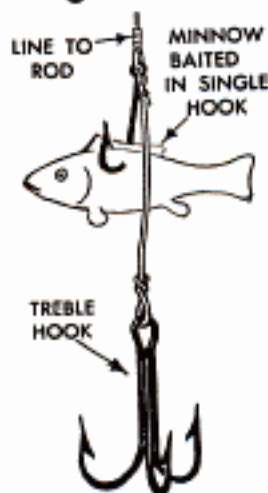

When you use a fishing line rigged with a snag hook as shown, very few of the fish who nibble at your bait will get away. A treble hook is attached to the eye of the bait hook, so that it hangs about 2 in. below the minnow, worm or other bait. At the slightest nibble, the rod is jerked sharply, and though the fish may not have taken the

bait, he will be snagged on the treble hook before he can get away.

Floors Given Light Wax Coat

When applying wax to hardwood floors, keep in mind the fact that too much wax darkens the wood and collects more dirt. To avoid putting on too heavy a coat, fill an old sock with the wax and apply it by rubbing lightly. You will find that a little wax

and more polishing gives better results. It is better to apply light wax coats more frequently than to apply one heavy coat. Also, be sure to use light coats if a power polisher is used. Heavy coats of wax have a tendency to "pile up" under the action of a power polisher.

Adjustable Rower's Seat For Flat-Bottom Boat

The seat of a flat-bottom boat can be made adjustable, so persons of different height may row in comfort. To do this, the seat is removed and fitted with a sash bolt

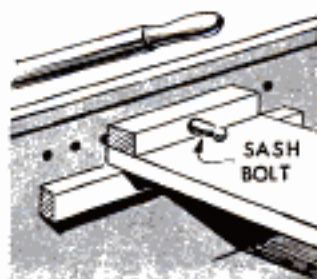

which is inserted in a cleat on each side, as shown. A series of shallow holes are drilled in each side of the boat, into which the sash bolts fit, and cleats are nailed under these to support the seat at the same height as the original installation.

G. E. Hendrickson, Argyle, Wis.

Old Railroad Ties in Garden Add Attractive Rustic Touch

An old railroad tie is an unromantic sort of thing and yet, when used in the garden, can help to provide an attractive rustic touch. In the photograph, a retaining wall at the end of a terrace has been built by stacking the ties. They also can be used to make garden steps, benches, terraced flower beds and wooden walks. The ties frequently can be obtained at no cost from railroads because the old ones usually are burned when new ones are laid. It is advisable to borrow a truck or trailer to haul the ties, as the creosoted wood is extremely dense and heavy.

Martin Snyder, New York City.



WTM 55

Things to Do With MILK CARTONS

By Jim Miller



Cutting down a milk carton to a height of 2 or 3 in. provides a neat, throwaway holder for solvent when cleaning small parts



"Mopping up" after cleaning paintbrushes is simple if a disposable milk carton is used to hold the turpentine or thinner



There's nothing as handy as these wax-coated cartons for carrying fishing worms, above, or starting house plants, right



Because of the intense heat with which they burn, the wax-coated milk cartons are just the thing for lighting bonfires



Above, there's no need to hunt for an empty can for small amounts of paint. A milk carton solves the problem nicely



Like mixing glue, above, the countless shop uses for milk cartons make it well worth-while to wash out and save them



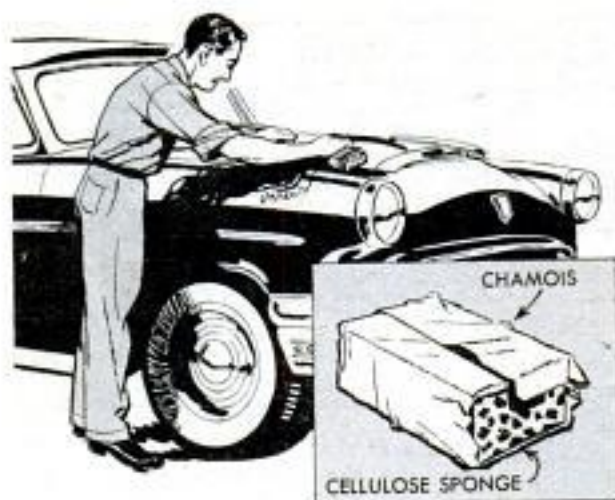

Sponge Holds Chamois Flat When Drying Car

To eliminate the annoyance of having the chamois wrinkle and roll up when drying a car, wrap the chamois around a cellulose sponge. The chamois will stay flat and smooth, but will be flexible enough to follow the contours of the car body. The sponge may be the same one used to wash the car.—Hugh Lineback, Stillwater, Okla.

Soak Tools to Remove Rust

Rust can be removed from tools by soaking them overnight in a solution of ammonium citrate, 1 tablespoonful, mixed in clear water, 1 pt. After soaking, the tools are rinsed in water, dried and coated lightly with oil.

Hinged Stop on Miter Gauge of Circular Saw Eliminates Waste

When cutting several lengths of stock to precise measurements on a circular saw, this hinged stop will speed up the job and eliminate any possibility of waste. Two pieces of hardwood are cut to the dimensions shown, the large one being fastened to a bar that slides on an extension on the miter gauge. The smaller one is a "gate" hinged to the larger. In use, the gate is closed and the stop is set so the distance between the saw blade and the stop is the correct length for the finished piece. To make the first cut, the gate is opened and the stock run through the saw. This gives one square end, plus a $\frac{3}{8}$ in. margin for the other cut. The piece is now reversed, the gate closed and the second cut results

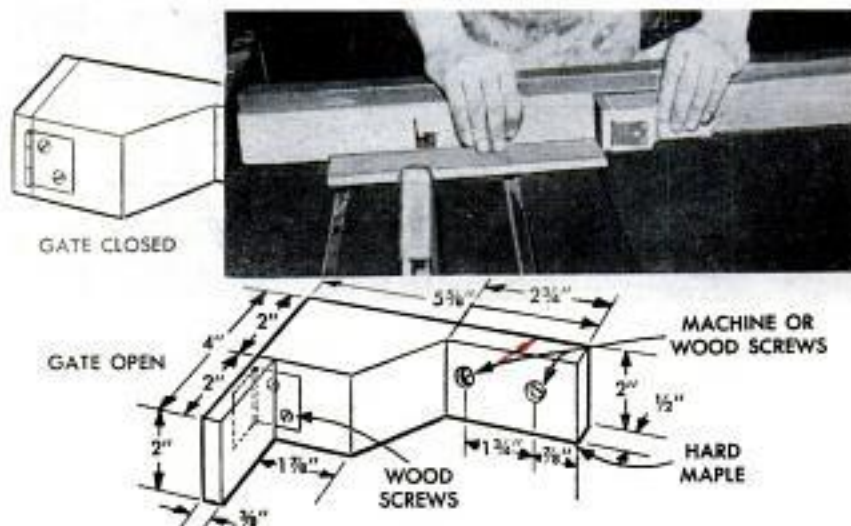

Storm Sash and Screens Marked With Carbon Paper and Die

A simple way to mark storm sash and screens is to stamp them with a set of number dies and a sheet of ordinary carbon paper. The carbon is placed on the area to be marked, and the number die is set on top of the paper and tapped with a hammer. Although the mark is fairly indelible, brushing a little varnish over the number will make it more completely weatherproof.

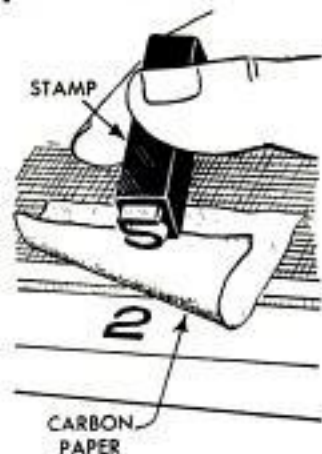

Insulation "Brushed" From Wire

A tin shield 3 in. square with a hole punched in the center of it to receive the wire is all you need to quickly strip the insulation from electrical wiring with a motor-driven wire brush. Push as much of the wire as must be stripped through the shield and hold it against the brush. The insulation will come off fast and clean. This is especially useful where a number of wire ends must be stripped, or where the insulation must be removed from a long piece of wire. Do not strip wire in this manner without shield to protect fingers.

WTM 55

Electro-Etched NAME PLATES

By
John Burroughs

THERE'S NOTHING like an etched-metal name plate to give a finished, professional look to a model, dress up a trophy or serve as identification on a tool or instrument. Electro-etching name plates is so simple that anyone can do it without previous experience. The electro-etching process is nothing more than electroplating in reverse. The brass name plate is connected to the positive cell of a 6-volt automobile battery and a strip of sheet copper is connected to the negative. Both are hung in a fruit jar containing copper-sulphate solution, and the brass plate becomes etched wherever the solution contacts the metal. Any part of the plate protected by a resist, such as wax or cellophane tape, won't etch. The proper etching solution to use is copper-sulphate crystals, 1 cup, dissolved in water, 1 qt., and stirred until the solution is a clear blue color.

To prepare for etching, cut a strip of brass to the desired size, and dip it in hot paraffin. Then, using any pointed tool, scribe the lettering in the wax and etch. For letters in relief on an etched background, use cellophane tape as a resist. Clean the plate with a fine abrasive cloth and lay on a strip of tape as long as the line of letters you want. Rub the surface of the tape with an ink eraser until it will take pencil marks and then trace the letters on it. Cut around them with the point of a sharp knife or a razor blade and peel away the background. If you want a raised border, apply tape to form the border and then etch the plate.

Etching time is in proportion to the amount of metal you want removed. Hang the plate in the solution with the side to be etched facing the copper strip. The back of the plate need not be covered. An immersion of 15 or 20 min. gives a reasonably deep etch. When etching is complete, the plate can be buffed and dipped in clear lacquer to preserve the brightness or the etched recesses can be filled with colored enamel. Use a baking enamel, laying it on heavily with a small brush, and bake about 1/2 hr. at 150-200 deg.

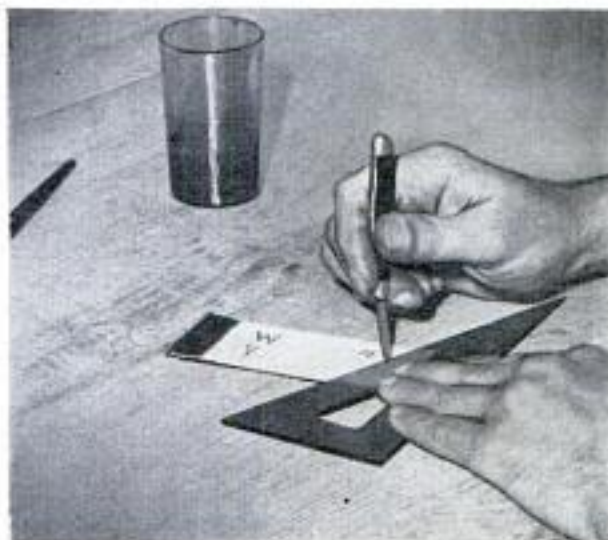
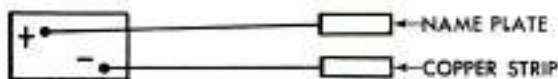

Above, a sharp-pointed knife is used to cut out or scribe lettering before etching. Below, the completed name plate, with enamel baked around the lettering, is dipped in clear lacquer to preserve polish





Wrapping Materials Are Dispensed Through Bottom of Cabinet

For the housewife who uses various kinds of wrapping materials, such as waxed paper, aluminum foil and freezer parchment, this cabinet arrangement provides a neat and convenient method of storage. A 1/4-in. slot for each type of material is first sawed in the bottom of a wall cabinet. Standard holders are then screwed to the inside of the cabinet, placed so the paper or foil will feed through the slots. A cutting edge is provided by a hacksaw blade which is screwed to a 1/2-in. strip of wood which, in turn, is screwed to the bottom of the cabinet at one side of each slot. The wood strip allows the wrapping to be gripped with the fingers.

Hubert W. Farris, Albuquerque, N. M.

Method for Hanging Screen Door

When hanging a screen door, place several thicknesses of newspapers between the bottom of the door and the threshold before screwing the hinges in place to assure clearance after the door is attached.

Winifred N. Jones, Provo, Utah.

Call to Colors

Believe it or not, you can change the apparent size of a room without tools. It's a matter of creating an optical illusion by the proper use of colors. Objectionable details can be played down and gaiety or dignity given a room, all with color know-how. Read about interior colors next month

Rear Sight on Gun Painted Red To Improve Accuracy of Aim

By painting the rear sight red, hunters can improve the speed and accuracy of their shotgun and rifle aim. This is a trick widely used by pistol shooters in Olympic competition and is especially helpful on moving targets such as animals and birds, where speed in aim is essential.

Gustavo A. Balcells, Toledo, Ohio.

Outboard Motor Stored on Bracket Fastened to Exposed Studding

An outboard motor can be stored in the correct vertical position when not in use by means of a simple 2 x 6 bracket fastened to the exposed studding in the garage wall. Gasoline and oil spillage can be kept to a minimum and any water left in the motor will have less chance of seeping into the block. The bracket in the illustration was attached directly to the 2 x 4 studding. A larger motor might require the addition of a 2 x 2 spacer to keep the motor far enough away from the wall. If the motor is mounted high on the wall, space beneath it can be used for the storage of gas and oil.

Ivan Grosvenor, Indian Rocks, Florida.





KNOW YOUR COOLING SYSTEM

A SUDDEN SPURT of steam from the radiator often is one of the few reminders to the average motorist that his engine has a cooling system; then it's too late. Severe damage to the valves, rings or cylinder walls may have been caused by this time. When you realize that the average 6-cylinder L-head engine generates enough heat to keep a 6-room house warm, it is apparent that the cooling system must be functioning at maximum efficiency to keep the engine operating temperatures within safe limits. Only about $\frac{1}{3}$ of the heat energy is utilized as power. Of the waste heat remaining, about $\frac{1}{2}$ is dissipated through the exhaust system; the rest must be absorbed by the cooling system.

A cross-section of a typical passenger-

car cooling system is shown at the bottom of this page. It consists of a radiator, its hoses, a water pump and fan, a thermostat, and the water jacket around the engine. Water is circulated through the system when the engine is running and, as it passes through the water jacket, absorbs heat which it carries to the radiator where it is dispersed into the air flowing through the radiator.

The radiator consists of a core with small tanks at the top and bottom. There usually is a baffle plate just under the filler opening of the upper tank to prevent water from surging out the inlet or overflow pipe. The bottom tank has an outlet connection only. There are two main types of radiator cores—the cellular and the

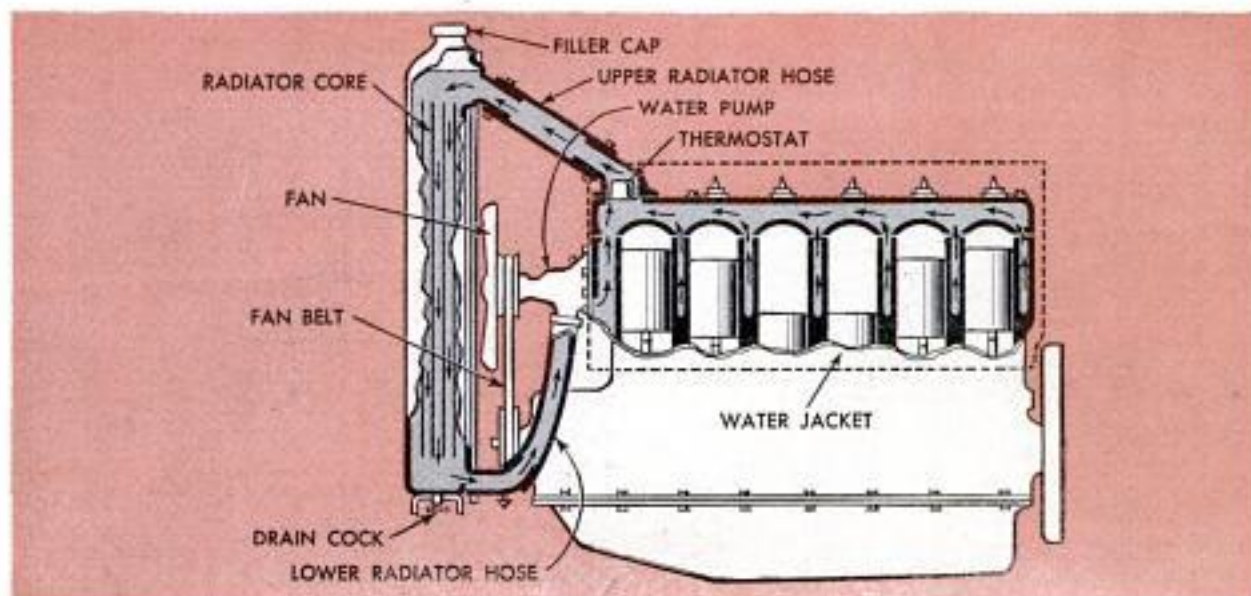

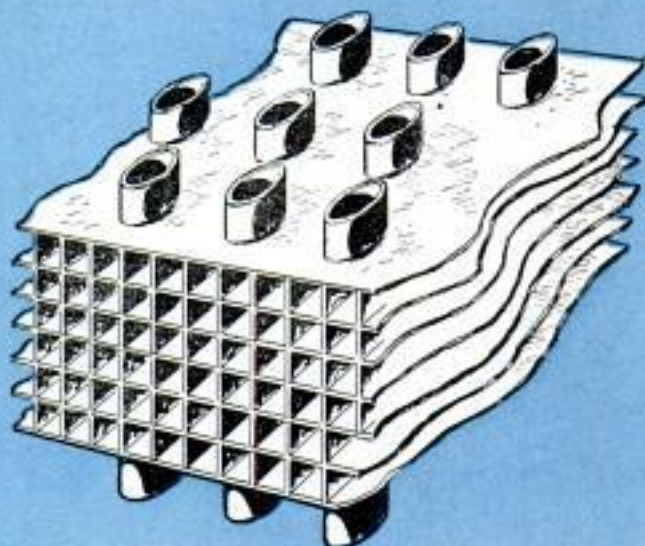

TUBULAR TYPE RADIATOR

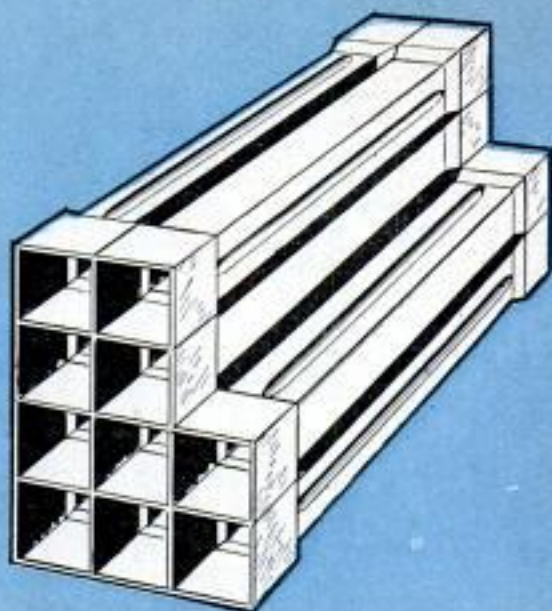

CELLULAR TYPE RADIATOR

Below are detailed two kinds of centrifugal water pumps. Each has the packless-type water seal around the impeller shaft although details of assembly vary between the two. The main difference in the pumps is that one has a brass bushing for a shaft bearing, the other ball bearings for heavy-duty service

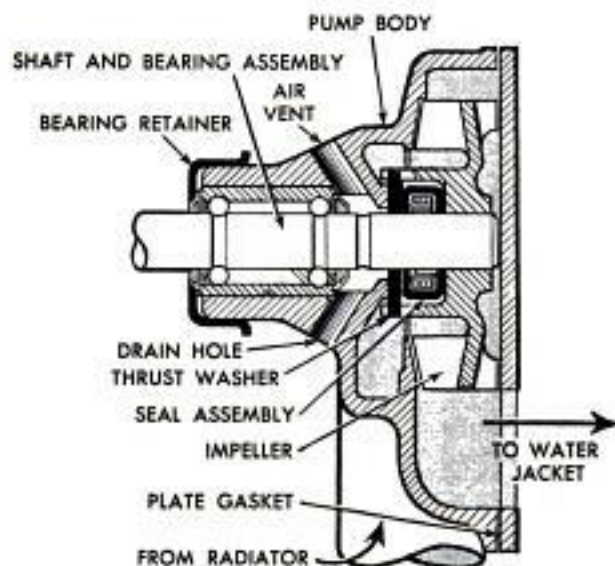
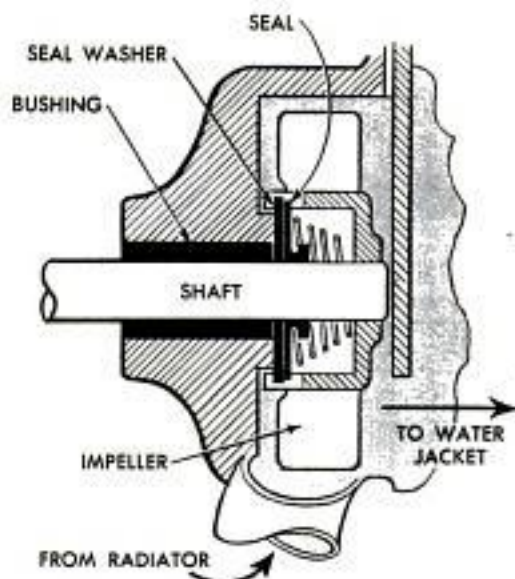

tubular. The cellular type is composed of short horizontal tubes or cells, their length determining the thickness of the core. Each tube has a flange around the four sides of each open end. When several thousand of these cells are soldered together by their flanges, water can flow around all four sides of each cell, thus presenting a huge radiating surface to the cooling air which flows through the inside of each cell. Although it is the most efficient heat-radiating device for any given size, the cellular type is expensive and does not lend itself to mass production as readily as the tubular type.

The tubular-type core is composed of vertical tubes of thin metal which extend through and are attached to closely-spaced thin metal fins. The top tank collects the hot water from the engine and distributes it across the radiator core, where it then runs down through the tubes. Its heat is dissipated through the tubes and into the fins where the air moving through the core picks it up and disperses it. The bottom tank simply collects the cooled water from the core and discharges it through the outlet to the water pump.

All modern cooling systems include a pump, located on the front or side of the engine, to circulate the water. It receives water from the bottom radiator tank and forces it through the water jacket, into the head and back to the radiator top tank. Almost all engines are equipped with the packless-type centrifugal pump. It has an impeller with blades which force the water away from it as it spins. The impeller is mounted on a shaft and is located inside the

pump housing. The outer end of the shaft is fitted with a pulley driven by a belt which runs from another pulley on the front end of the crankshaft. On some engines the water pump is coupled to the generator shaft. The problem of keeping the water from leaking out around the shaft of the impeller is solved by a self-adjusting seal. Both water pumps illustrated have this type seal, though details of assembly vary. The main difference in the two pumps detailed is that one has a brass bushing for a shaft bearing, while the heavy-duty type in the lower detail has two sets of ball bearings. It also has a drain hole and air vent just in front of the seal so that any minor leak of water will be thrown clear. The latter type of pump is used on heavy-duty engines.

The fan, which on most engines is mounted as a unit with the water-pump pulley, draws a large volume of air through the radiator core to cool the water, and also provides direct cooling of the engine by blowing air over it.

The cooling system of an engine is designed to provide adequate service when the engine is operating under heavy loads and in hot weather. Under light loads or in cold weather, the same amount of cooling would be too much. Overcooling results in rapid engine wear; fuel and power are wasted because the heat energy that should be driving the pistons is absorbed by the cooling water. To prevent overcooling, a thermostat is used to control the flow of water. The most commonly-used thermostat is the bellows type, shown in the upper illustration on this page in both the open and closed positions. The bellows expand with heat and contract with cold, thus opening and closing the thermostat valve. The thermostat usually is located in the outlet of the cylinder head, as shown in the cross-section on page 197. When the engine is cold, the thermostat is closed and prevents the water in the water jacket from flowing into the radiator. When the engine warms up, the thermostat slowly opens, permitting the water to circulate.

Many radiators are equipped with a pressure cap on the filler which seals off the overflow pipe during normal operation to prevent loss of water due to surging and, by keeping the water under pressure, raises the required boiling point of the water.

The engine water jacket consists of a number of passages inside the engine block and cylinder head. It completely surrounds the cylinders for their full lengths and carries water around the valve seats. The water jacket in the cylinder head covers the combustion chambers and in valve-in-head engines also cools the valve seats. Many L-head engines also contain a water

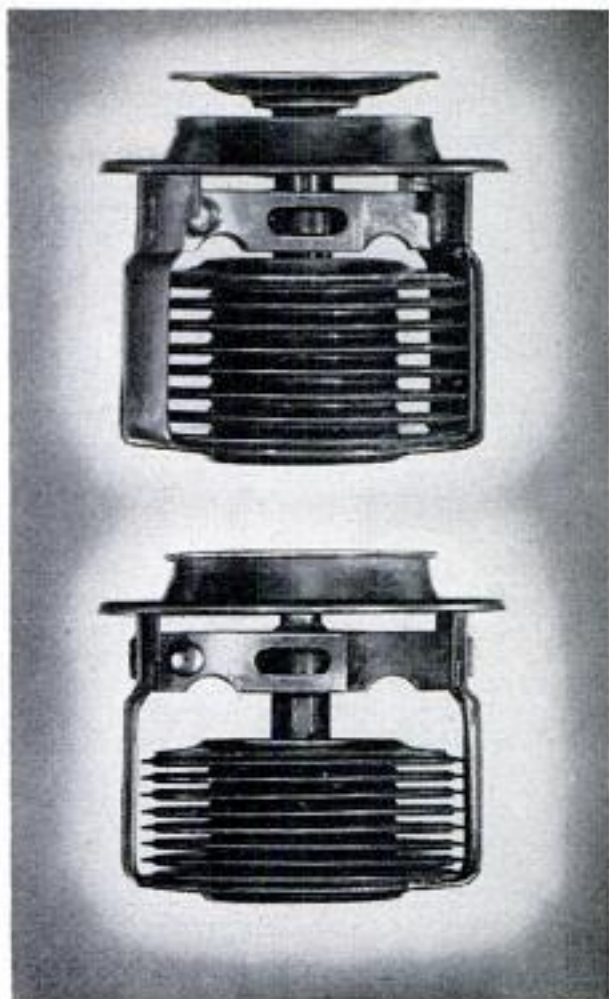

In the photographs above is shown the commonly used bellows-type thermostat. A liquid in the bellows boils at a predetermined temperature and expands the bellows which lifts open the thermostat valve. The upper photo shows the thermostat in the open position

Below is illustrated the method for testing thermostats to determine whether they are opening at the proper temperature range. The thermostat is suspended in water and heated to the specified temperature

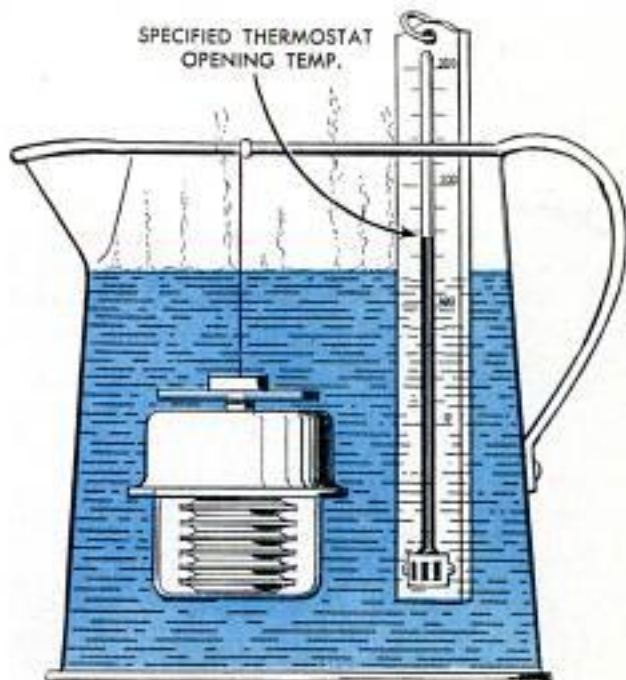

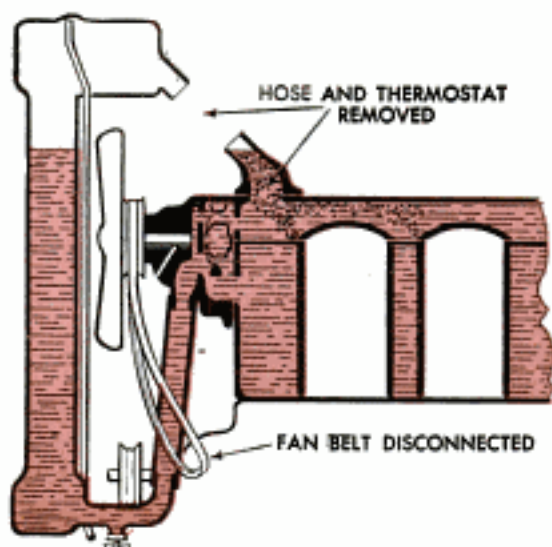

Test for combustion gas leaks in the water jacket caused by bad head gasket or cracks in head or block

distribution tube in the water jacket which extends horizontally back from the water pump. Holes in the tube direct water against the underside of the exhaust-valve seats.

Although water has excellent heat-transfer properties and is available almost everywhere, it has definite drawbacks. It has a comparatively low boiling point, a fairly high freezing temperature and a natural corrosive action on metals. A radiator completely filled with water will overflow when the water heats and expands. Antifreeze must be added to the water in cold weather to prevent freezing. Rust-inhibitor should be kept in the water when no antifreeze is used. Standard antifreeze solutions contain a rust-inhibitor of their own which is efficient.

When checking an automobile for overheating, be sure that the brakes are not dragging and that there is plenty of oil in the crankcase. Bad ignition timing also will cause overheating. Examine the engine for external leaks in the hoses, radiator and head gasket. Be sure the fan belt has only about 1 in. of play. If it is frayed or oily, it should be replaced. Test the thermostat by suspending it in water and heating it to the specified temperature, as shown in the illustration on page 199. If the thermostat opens at a temperature more than 10 deg. F. below specified temperature or fails to open at a temperature of 10 deg. F. above the specified temperature, it should be replaced with a new one.

Check for internal leaks of combustion gas into the water caused by a leaking head gasket or cracks in the cylinder head or block. To make this test, remove the upper hose and thermostat, drain the water down to the level of the engine block and disconnect the fan belt. Then pour water into the

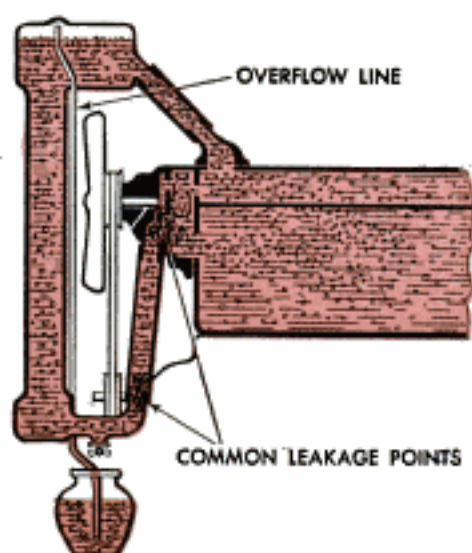

Test for air suction in system. Air will cause foaming and loss of heat-transfer properties of water

radiator until the water outlet on the head overflows. Start the engine and accelerate it 6 or 8 times. If bubbles appear it indicates a combustion leak.

Next, check for air being sucked into the cooling system. This causes foaming which greatly lowers the ability of water to absorb heat. The foaming water also will overflow, causing a low water level. Air suction usually occurs through a leak in the pump or in a connection between the pump and radiator. To test for this trouble, lower the water level enough to eliminate the chance of overflowing from expansion. Then block open the pressure valve on the outlet cap and tighten it securely on the radiator. Attach a hose to the overflow pipe and insert the free end in a container of water. Run the engine until the temperature remains constant. Then, with the engine running at a fairly rapid speed, watch for air bubbles in the container. If there is no internal leakage of combustion gases, the presence of bubbles indicates air is being sucked into the cooling system.

If your engine runs too cool, check the thermostat and, if necessary, cover part of the radiator to adjust the temperature to a safe level.

Inspect your radiator core every spring and fall. If it needs cleaning, use a good grade of cleaning compound and reverse-flush as directed on the package. A badly clogged radiator will require the services of a professional radiator-cleaning shop. There are devices on the market which may be suspended in the radiator to assist in preventing corrosion and clogging in the radiator core.

As in other parts of an automobile and its engine, preventive maintenance will eliminate trouble and save money. The cooling system must function efficiently. ★ ★ ★

"Kit" Permits Variety of Bric-a-brac Shelves

An infinite variety of sizes and shapes of bric-a-brac shelves can be assembled from precut and notched hardboard strips. The hardboard is cut into strips 2 in. wide, in 9, 12 and 15 in. lengths. Slots $\frac{3}{8}$ in. wide and 1 in. deep are cut 2 in. from both ends of the 12 and 15 in. lengths, and $1\frac{1}{2}$ in. from the ends of the 9 in. lengths. With a number of strips on hand, various combinations may be tried until a suitable size and shape is found. The unit can then be glued, and later painted or finished to match any decorating scheme. The best

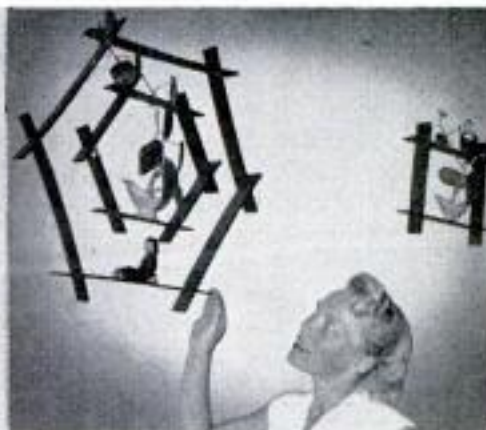
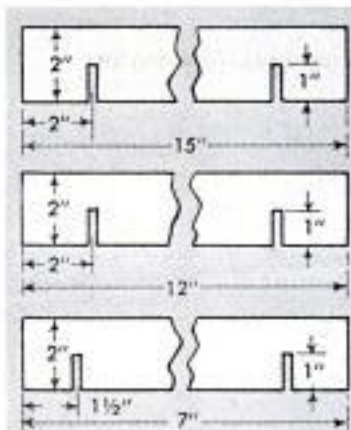

type of hardboard to use is that which is finished on both sides. It is available in $\frac{1}{8}$, $\frac{1}{4}$ and $\frac{1}{2}$ -in. thicknesses.

George Van Volkenburg, Key West, Fla.

Plane-Iron Sharpening Jig Is Made From Wood Scraps

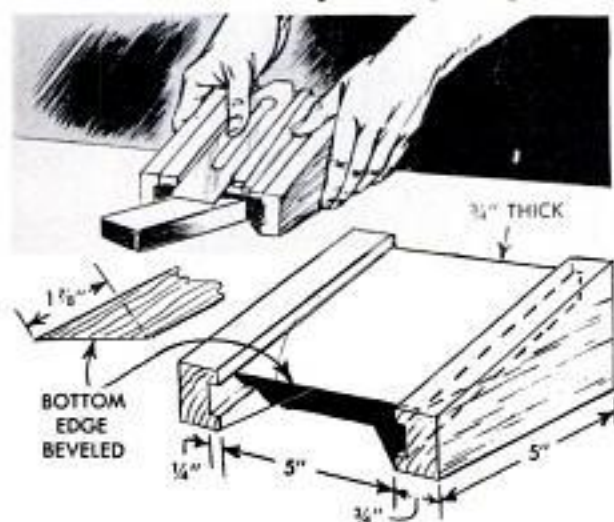

Holding a plane iron at the correct angle for sharpening the cutting edge can be done quickly and accurately by using this jig. The two sides are cut to taper 2 in. in the 5 in. length. The top piece, which should be about twice as wide as the sharpening stone, is held in grooves cut in the side pieces. The bottom edge of the top piece is beveled to be parallel to the surface of the stone. The distance from the bottom of the jig to the underside of the top plate is determined by the thickness of the stone. To align the iron for sharpening, a block is placed on one side and two thin wedges on the other. Clamping the blade down will cause it to dig into the stone.

Edward E. Thorp, Montclair, N. J.

Pillow Kept on Camp Cot by Removable Headboard

Tired of having the pillow fall off the end of his folding cot and groping around in the dark to find it, one camper fitted his cot with a removable headboard. The board itself is a piece of $\frac{1}{2}$ -in. plywood, 4 in. wide and 29 in. long which is sanded smooth and waterproofed with two coats of spar varnish. Two lengths of light pipe strap are formed to go around the wooden cot spreader and fastened to the headboard. Two pieces of $\frac{3}{16}$ in. x 2-in. flat steel are bent to form L-shape brackets, one end of each being bent upward to bear against the side rail of the cot. A $\frac{1}{4}$ -in. flat-headed stove bolt is used in the lower hole of the bracket so it will clear the spreader bar. To remove the headboard when folding the cot, just pull out the spreader bar and lift it off. The headboard can be strapped to the cot when transported or stored away.

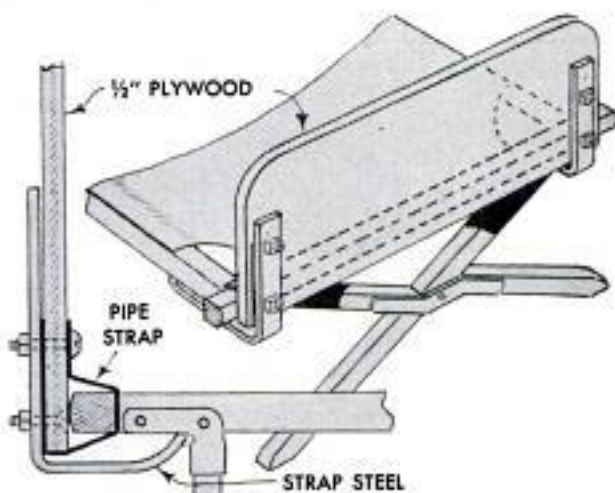

☛ To remove mustard stains from fabric, rub the spot with glycerin and then wash in soap and water.

MODELING THE MIDWAY

Part III

By Paul Strayer

NOW THAT YOU have completed the flight deck, the gallery piece and the cover board which make up the upper three-piece assembly of the model *Midway*, you are ready to tackle the superstructure called the "island." Here in this island on the starboard side of the actual ship is installed the maze of incredibly complicated apparatus upon which virtually depends the operation of the carrier. The island is an immense structure, measuring some 12 ft. wide and 130 ft. long. The huge stack itself rises approximately 40 ft. high and is 50 ft. long.

The island on your model of the mighty *Midway* measures only a mere 3 in. long and yet it is minutely detailed. Begin by tracing the full-size pattern for the island, which is given on the opposite page, on a block of 1/2-in.-thick pine and then saw it neatly to line. You'll note in studying the drawing on the opposite page that this piece serves as a blank to which all the tiny component parts are glued. All these parts are shown actual size to make it easy for you to duplicate them simply by taking measurements with dividers. The portion of the island block that represents the stack, or funnel, is rounded at each end with a file and sandpaper. The rakish stack canopy is a separate piece, glued in place so it overhangs the sides of the stack but not the ends. The three squares on top of the canopy are cut from thin cardboard, such as Bristol board, and are glued in the position indicated. The island blank is held to the flight deck with two 1/8-in. dowels.

The tripod mast, which is a part of the island, is preassembled in a

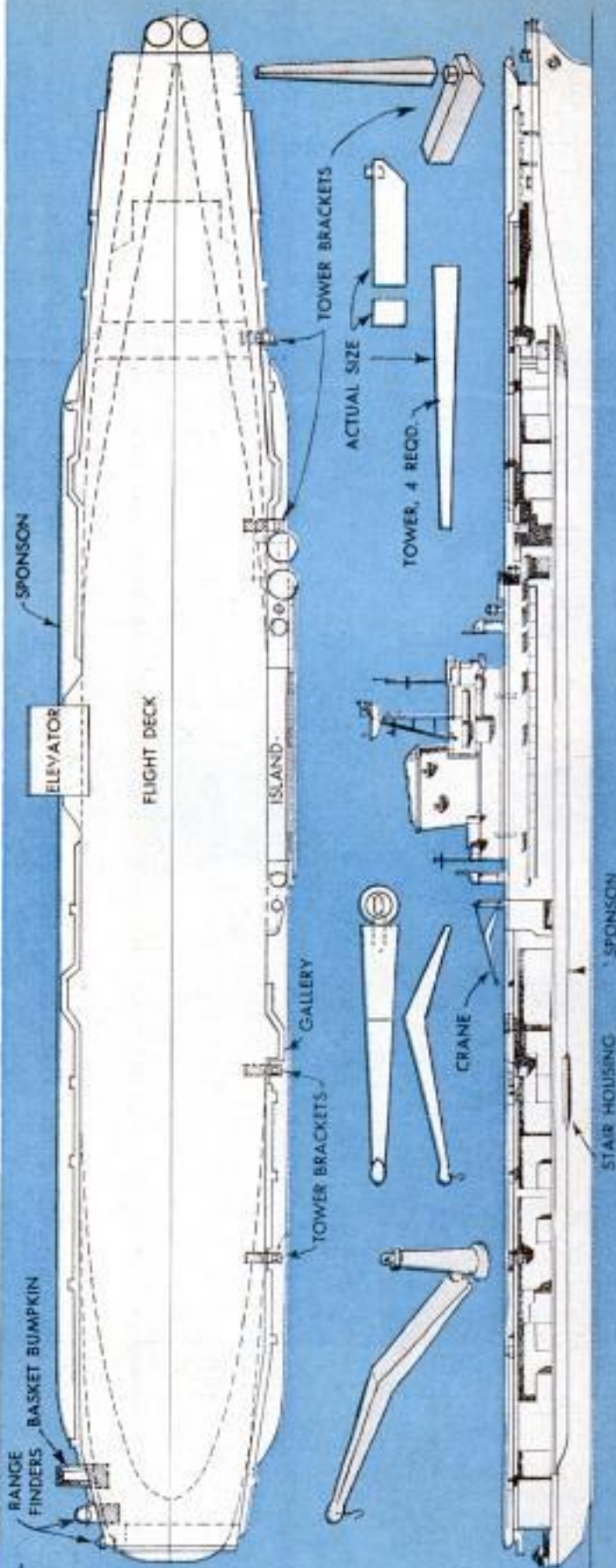



ASSEMBLY OF TRIPOD MAST

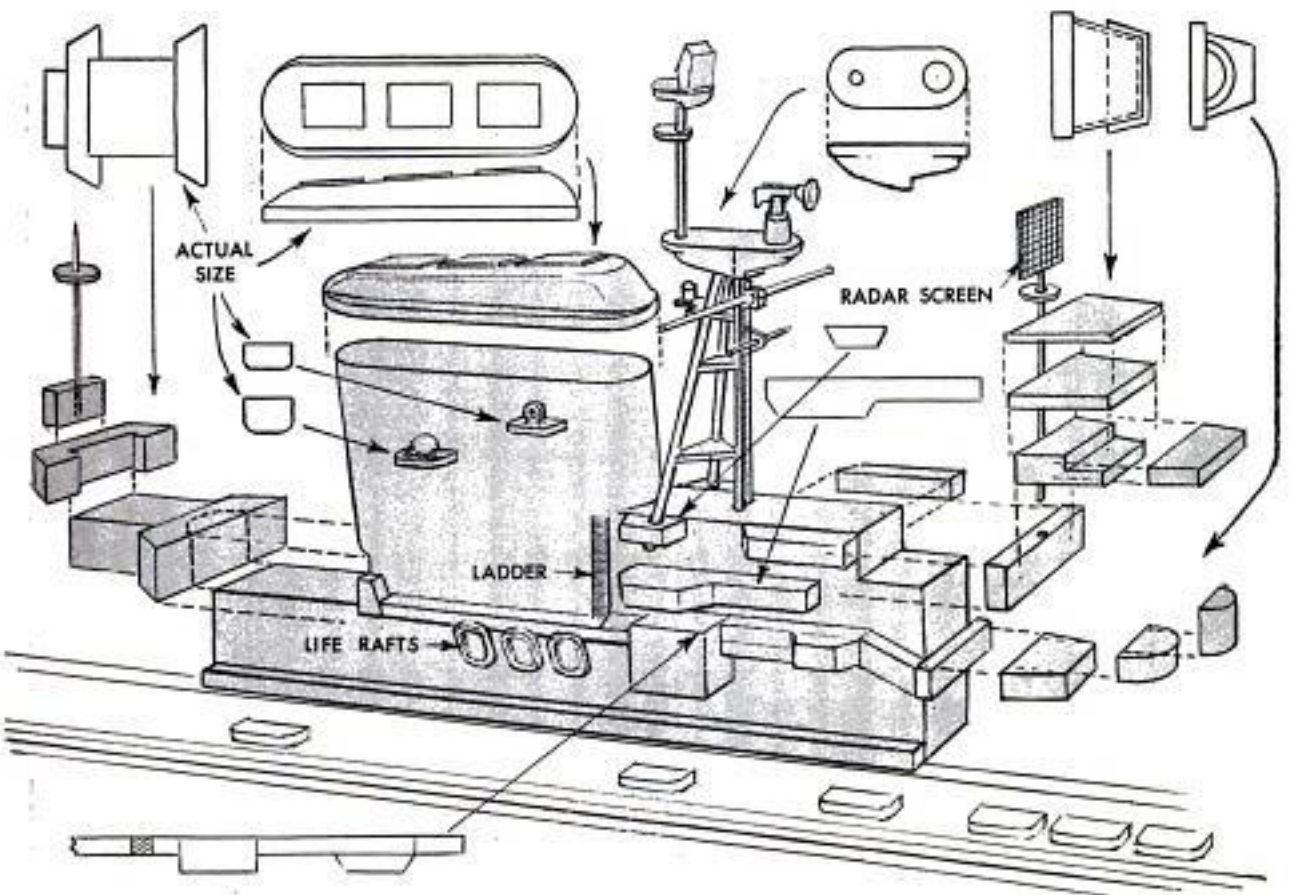
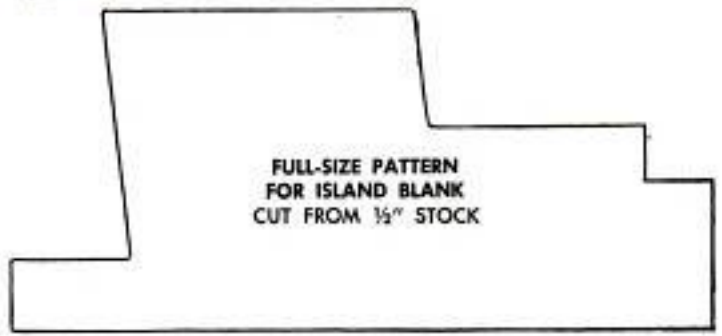

PULLAPART ASSEMBLY OF ISLAND SUPERSTRUCTURE

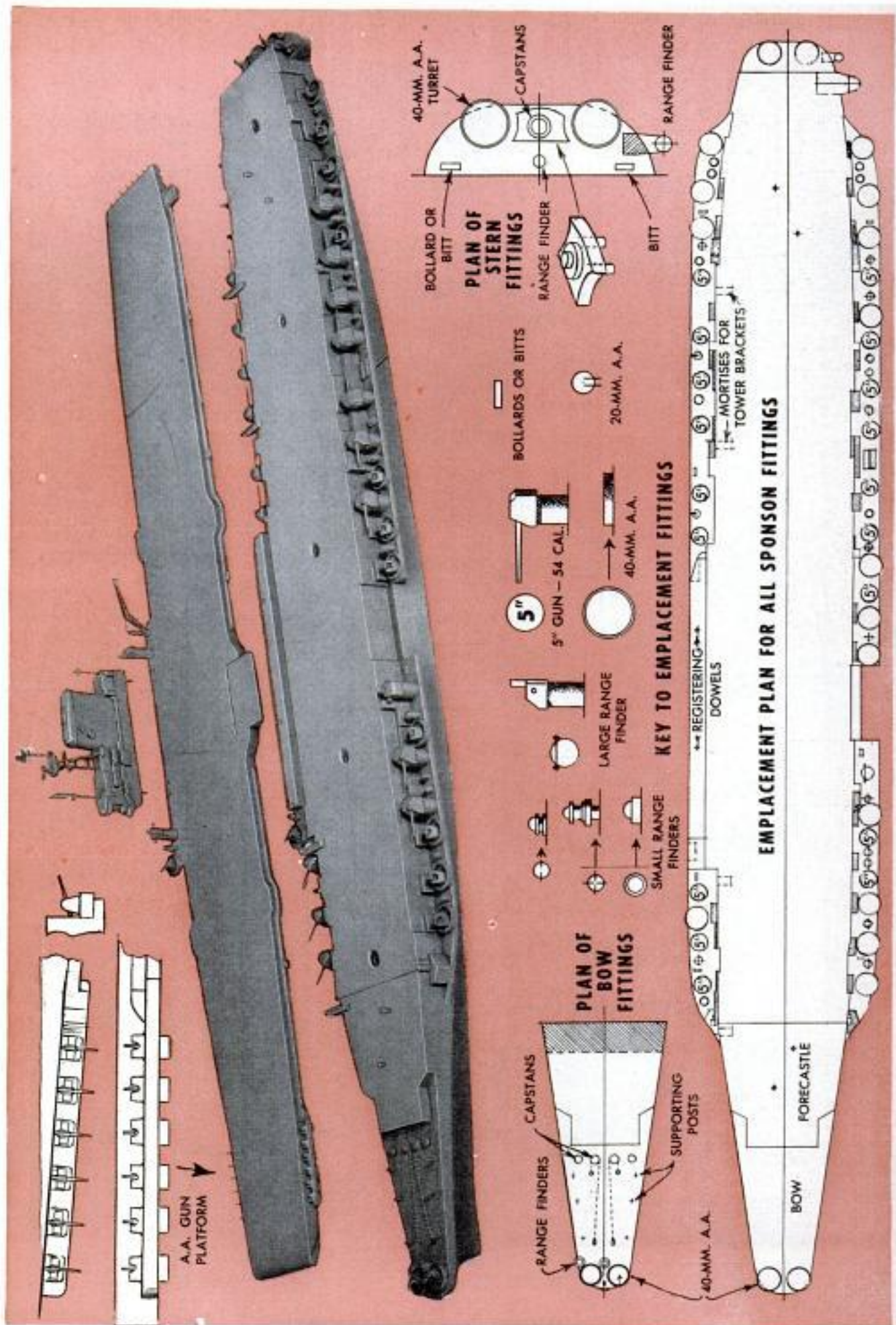

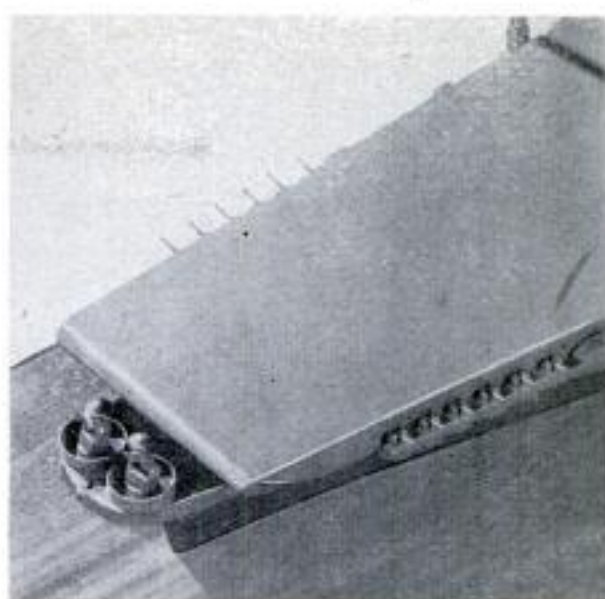
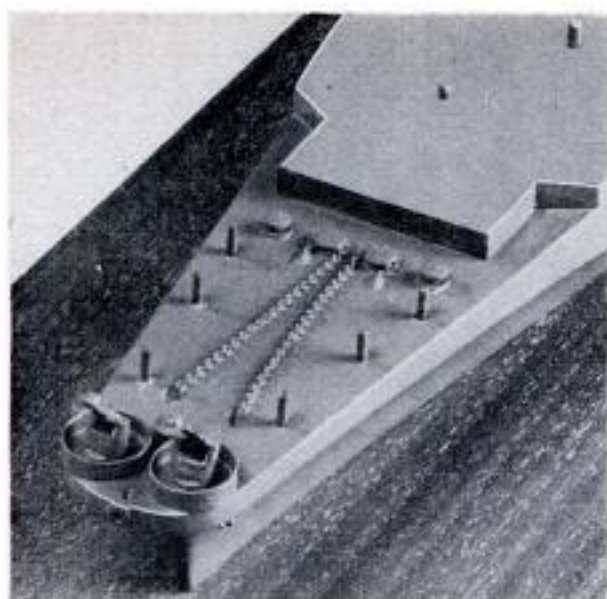

Closeup views at the bow. In the left-hand photo the flight-deck assembly has been removed to expose the deck fittings on the forecastle. Note in the right-hand photo the batteries of 20-mm. AA guns, each side

jig. Drill three holes in a scrap piece of wood, following the triangular plan of the tripod base. The forward hole should be drilled vertically, about $\frac{3}{8}$ in. deep, while the two aft holes should be spotted so they will fall at a point where two small galleries jut from the sides of the island blank. These aft holes should slant inward so that all three legs of the tripod will meet at the top. The legs are cut from 54-ga. drill rod and should be long enough to support the mast platform about 1 in. above the deck. The three legs are soldered together at the top. When this is done, the mast can be removed from the jig and set in position on the island. Note that the aft legs of the tripod extend just barely below the galleries which jut from each side. The small triangular-shaped braces between the legs are cut from thin pieces of metal or cardboard and are fitted in place by gently forcing them upward between the rods with tweezers until they wedge in place. A spot of shellac or quick-setting household cement applied with a toothpick will hold them in position. The small platform supported by the mast is drilled to fit down over the soldered ends of the three legs.

The two signal masts are made from 58-ga. drill rod and the $\frac{1}{16}$ -in.-dia. platforms which fit down over the ends are cut from thin Bristol board. The radar screen is made of the same material and one side is scored to represent the screen. The remaining components of the tripod mast are made from bits of wood, following the actual-size patterns of each, and are fastened to the island block in their respective positions with quick-setting cement. The two ladders, one on the tripod mast and the other on the starboard side of the stack, are cut from single-ply Bristol board and

measure $\frac{3}{16}$ in. wide. Scored lines represent the ladder rungs.

Deck fittings: The position of the various fittings on the forecastle (not to be confused with the forecastle piece previously discussed in Part I) is shown in the bow plan on page 204 and the left-hand photo on page 205. The fittings consist of two 40-mm. A.A. turrets, two large, low capstans around which the anchor chains pass, two smaller capstans, two range finders and six supporting posts for the overhanging forward deck. The posts are 54-ga. drill rod set in holes and made long enough to touch the underside of the flight-deck assembly. The anchor-chain size is 24 links to the inch and it can be purchased from most ship-model supply shops. Two lengths of chain are needed and each one is installed by inserting one end in a simulated hawse pipe, which is simply a hole drilled in the deck, and securing it with a drop of quick-setting cement. The other end of the chain is brought around one of the large capstans and carried forward $\frac{1}{4}$ in. and into a spurling gate. Again, the spurling gate is represented by a hole in the deck and the chain is anchored with a drop of cement.

The deck fittings at the stern consist of two 40-mm. A.A. turrets, two range finders (one being raised between the two turrets) a capstan and two bollards. These bollards, or mooring posts, also appear in various positions on the sponsons. Each one is made by cementing a tiny Bristol-board rectangle, $\frac{1}{16} \times \frac{3}{16}$ in., to the surface and then driving two minute lengths of 76-ga. wire in predrilled holes in the board. These tiny bollard fittings can be omitted, if you wish, without any appreciable loss to the appearance of the model.

Crane and tower patterns are given in

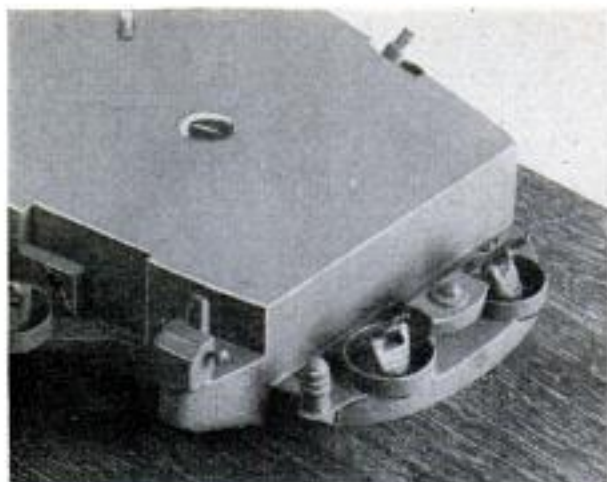

Closeup view of stern with flight-deck unit removed, shows the arrangement of the various deck fittings

the drawing on page 202. The towers are made from a strip of wood $\frac{1}{8}$ in. square. I find it more practical, in working small parts like this, to shape them individually from a long strip and then cut them off to the specified length. The towers taper from a point $\frac{3}{16}$ in. from the bottom and are $\frac{1}{32}$ in. square at the upper end. The four towers are supported by brackets which jut beyond the edge of the flight deck. You may recall that notches for the tower brackets were previously formed when the notched piece was cut. Glue and small lils (dress-

maker's pins) are used to anchor the brackets in their respective notches. Properly fitted, the brackets will project half their thickness above the surface of the notched piece. You'll notice that the towers are actually tenoned to the brackets to reinforce them. A hole is made in the lower end of each tower to set over a tenon fitted in the end of each bracket. With careful handling, however, the towers merely could be glued to the brackets as the plastic case will protect these fragile parts from breakage. The crane is carved from a single piece of wood, and the crane tower is turned from a short length of dowel, the tower measuring $\frac{1}{2}$ in. high.

The life rafts are cut from 3-ply Bristol board, $\frac{3}{32}$ in. wide and $\frac{7}{32}$ in. long. Round the ends and dish the center with the flat head of a nail, filed oval shape to leave a $\frac{1}{32}$ -in. margin all around the edge of the raft. As shown on page 203, three of these are cemented in a row to the starboard side of the stack, letting them slant inward to touch the surface.

In a concluding article next month you will be told how the range finders are made, as well as the 5-in. guns and turrets and the 40-mm. anti-aircraft guns and carriages. Details also will be given for mounting the model, painting it and building a protective plastic case. ★ ★ ★

Popular Mechanics Bookshop



For Photographers

Here's a basic handbook on photography. *How to Take Better Photographs*, in clear text and illustrations, takes you through all the essential steps. Starting with equipment and picture-taking techniques, it covers lighting, composition, and darkroom know-how. The price is \$2.50



For Teen-agers

How and Where to Obtain a Summer Job is the book for youngsters graduating from high school or working between college terms. This directory tells where to look for jobs, how to choose them and what jobs are likely to serve as training for a lifetime occupation. Price, 75 cents



For the Golfer

Directory of Golf Courses covers the courses on the North American continent. Included are all the vital statistics—name, location, number of holes, yardage and type of greens. The author rates each course and makes valuable comments on all of the tricky holes. The price, \$1.00

All books available from Popular Mechanics Press, 208 E. Ontario St., Chicago 11, Illinois

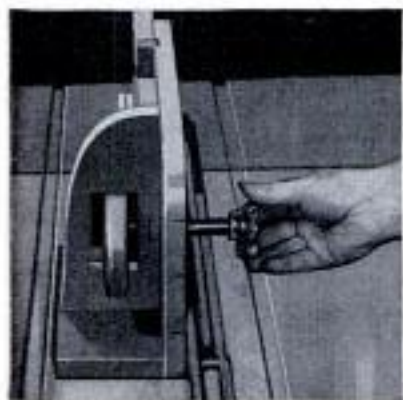

Before running cut on work, right, adjust clamp arm to parallel position with hand wheel as above

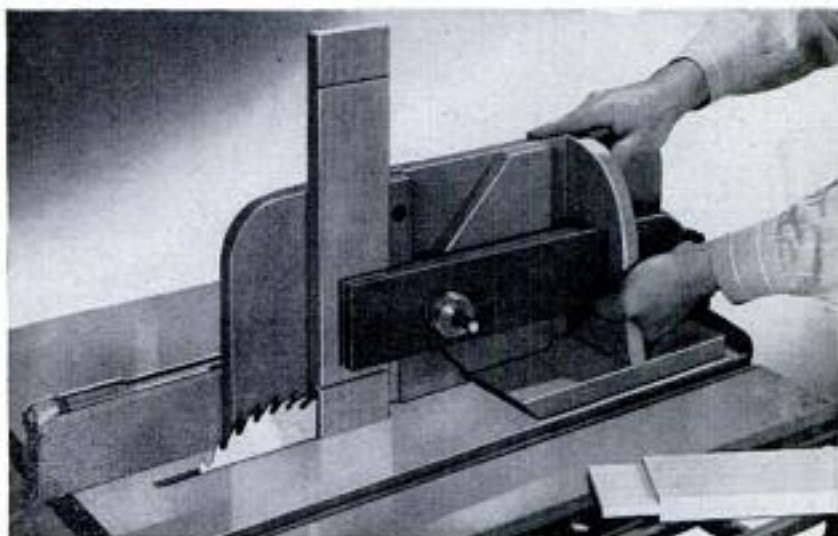

LEVER-ACTION TENONING JIG

By Sam Brown

A TENON JOB on the circular saw requires the accuracy of a jig which provides for clamping the work firmly in a vertical position while the cuts are being made. The jig pictured above and below and detailed at the right consists of a right-angle frame made by joining two selected pieces of hardwood stock edge to face with screws and glue. The longer vertical member is grooved and slotted for the backstop as detailed. The 45-deg. angle plate, cut from hardwood, is glued and screwed to the face of the vertical member with the forward end flush with the edge of the backstop groove. When the angle plate is

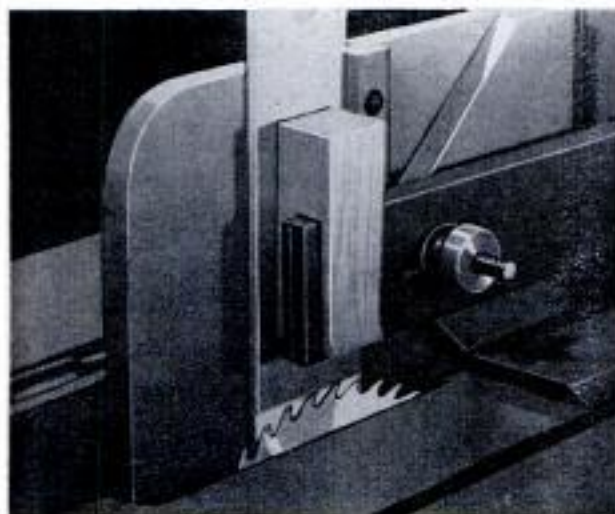
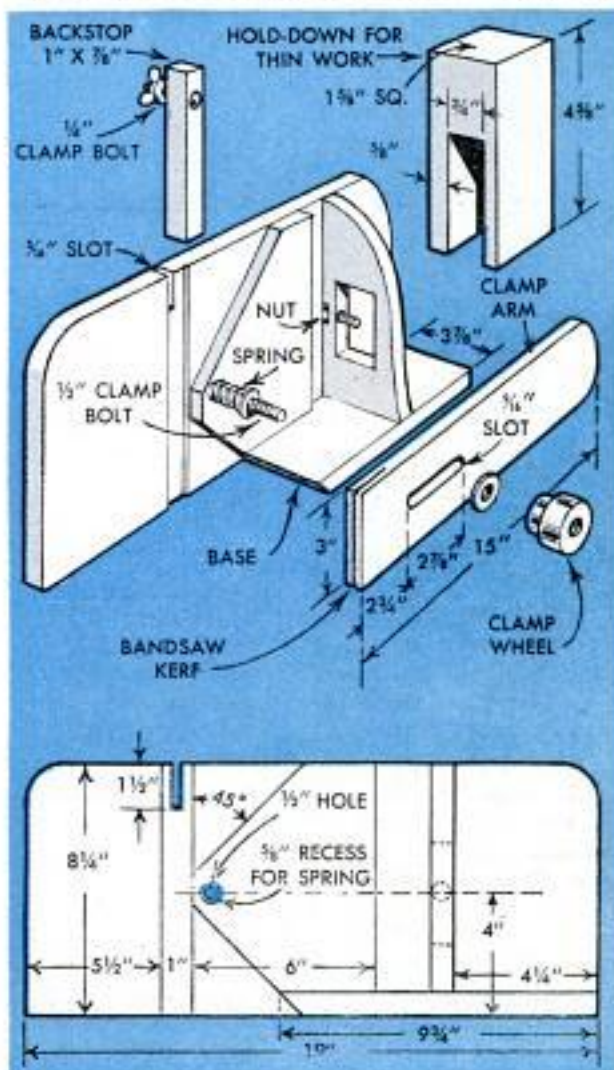

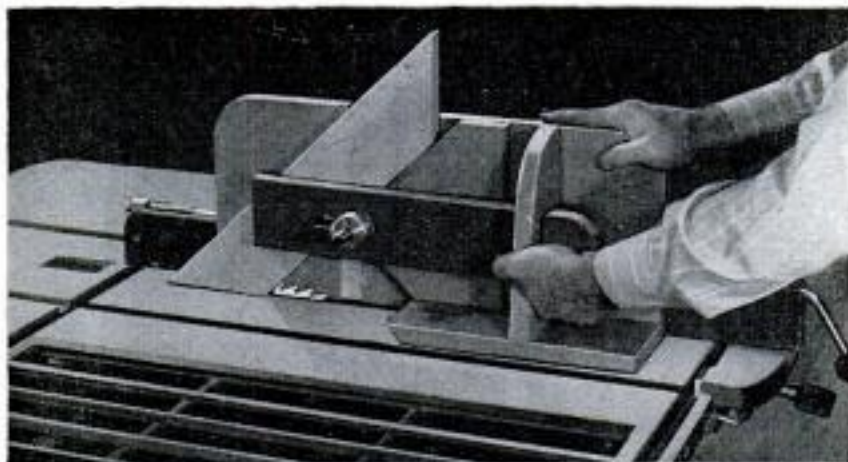

When cutting tenons or grooving ends of stock mitered at 45 deg., backstop is removed. Photo above shows first grooving operation for spline

In the second position, toe of miter bears against base piece, or shoe, of jig. When cutting tenons, run shoulder cuts first on each end of stock

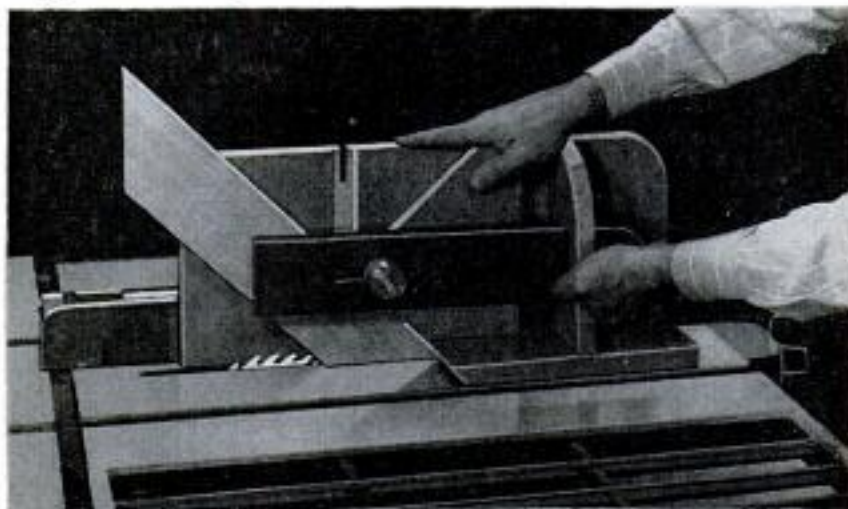

used backstop is removed for clearance.

When these three parts have been fastened in position, a brace is fitted as in the detail. The brace is mortised through to take the free end of the arm. Note that the brace is grooved to house a nut between it and the vertical member. The latter is drilled at this point with an oversize hole to take a $\frac{7}{16}$ -in. cap screw. The hole is continued through the brace into the mortise. Note also that the vertical member is counterbored to $\frac{1}{2}$ and $\frac{5}{8}$ -in. diameters near the end of the angle plate. The counterbore is made about $\frac{1}{4}$ in. deep which is sufficient to seat the inner end of the spring on the $\frac{1}{2}$ -in. clamp bolt holding the clamp arm. The free end of the clamp arm bears against the end of the bolt passing through the brace into the mortise, the bolt providing an adjustment for keeping the arm parallel to the work. Note in the detail that the clamp arm is slotted $\frac{5}{16} \times 2\frac{3}{8}$ in. so that it can be shifted to accommodate work of varying widths. Note also that the clamp arm is kerfed across the end with a band-

that it is parallel, or very nearly parallel, with the vertical member of the jig. This is done by tightening the bar lightly on the stock with the clamp wheel (a $\frac{1}{2}$ -in. nut may be substituted for the clamp wheel shown). Then adjust the arm with the cap-screw that bears against its free end as in the upper left-hand photo on the preceding page. In this view the cap screw has been fitted with a small hand wheel. Saw kerfs run in the back face of the vertical member of the jig as in the upper and lower left-hand photos on the preceding page will prevent it from warping. ★ ★ ★

Securing Temporary Wire Fencing

To simplify the job of putting up and taking down a temporary wire fence, use slats, such as wooden lath, nailed over the wire at each post instead of staples. Attached to the post with only two or three nails, each slat can be pried free easily with a crowbar to remove the wire.

Ted Otsu, Vancouver, B. C., Can.

Desiring shelter for his tractor without the cost of constructing a permanent building, one farmer borrowed the idea of the modern carport, but improved on it by making a "tractorport" that folded. One side is hinged to an existing building, such as the barn, and the other side is supported by two hinged posts, thus allowing the shelter to fold flat out of the way when not in use. The posts are held against the shelter by long bolts when it is folded, as shown in the detail. Shingles or roofing paper are applied to the top surface to prevent leaks in rainy weather. This shelter also is easily transported when moving to another farm.—Ervin L. Strayhorn, Beebe, Ark.

Low-Cost Hinged "Tractorport" Stores Simply by Folding Against Barn Wall

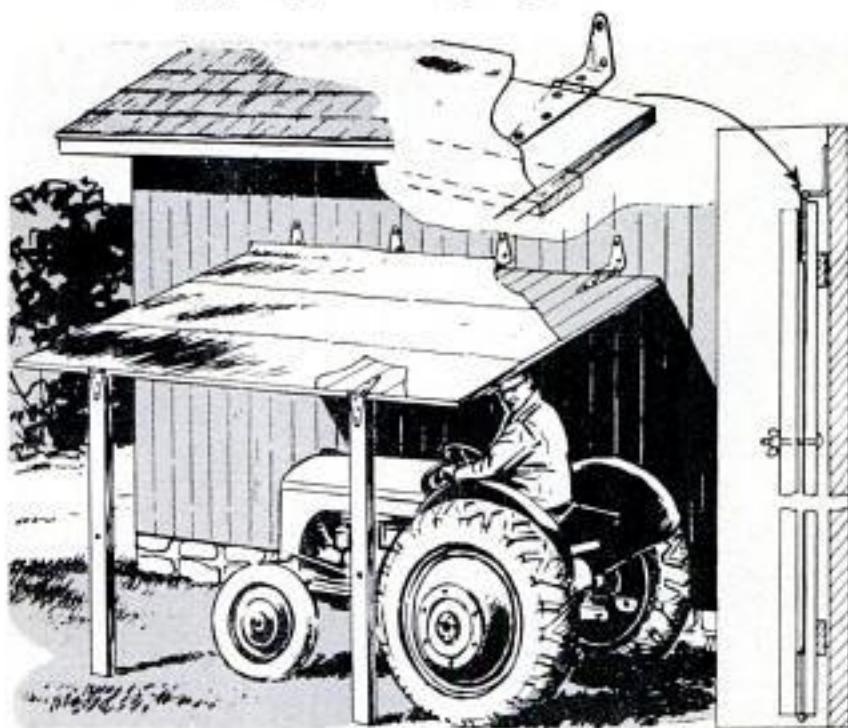

Wire-Solder Hook Assures Submerging of Pail in Cistern

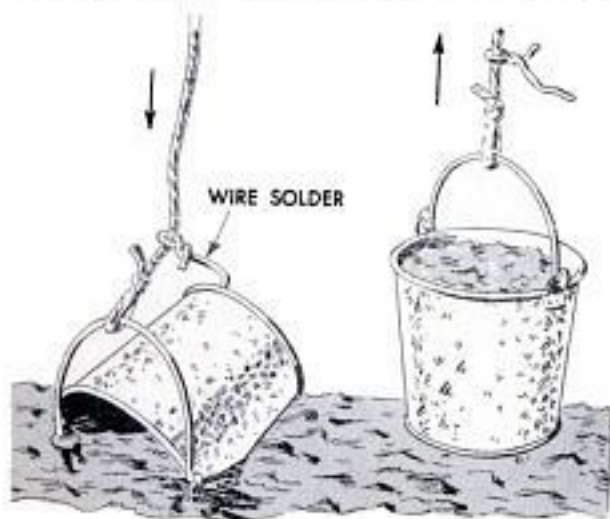

The difficulty of submerging a pail to fill it when dropped into a deep cistern may be overcome by using a hook made from wire solder. One end of a length of solder is twisted into a loop around the pail rope. The other end of the solder then is bent to form a hook which will catch the flange on the bottom of the pail. The hook is shaped to hold the pail so the top will enter the water first. As the pail fills with water, its weight will pull it down, and a quick tug on the rope will straighten and release the hook. The filled pail then may be lifted. The wire solder can be reshaped an indefinite number of times without breaking. Do not kink the solder, but make a gentle bend when forming the hook.

Clothespins Provide Leveling Wedges for Resilvering Mirrors

One shop that specializes in resilvering mirrors has found that the halves of spring-type clothespins provide excellent wedges for accurate leveling. The clothespin halves are all of the same size and shape and thus can be interchanged. As shown, the glass is being leveled preparatory to flowing the silvering solution over it.

Ken Murray, Colon, Mich.

☐ For complete maintenance of an automobile engine, occasionally snug-up on all the oil-pan bolts, to prevent an oil leak around the gasket.

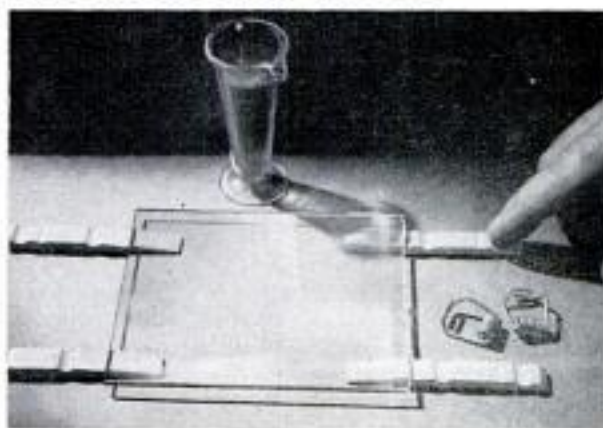

FLAME SOLDERING

By Sam Brown

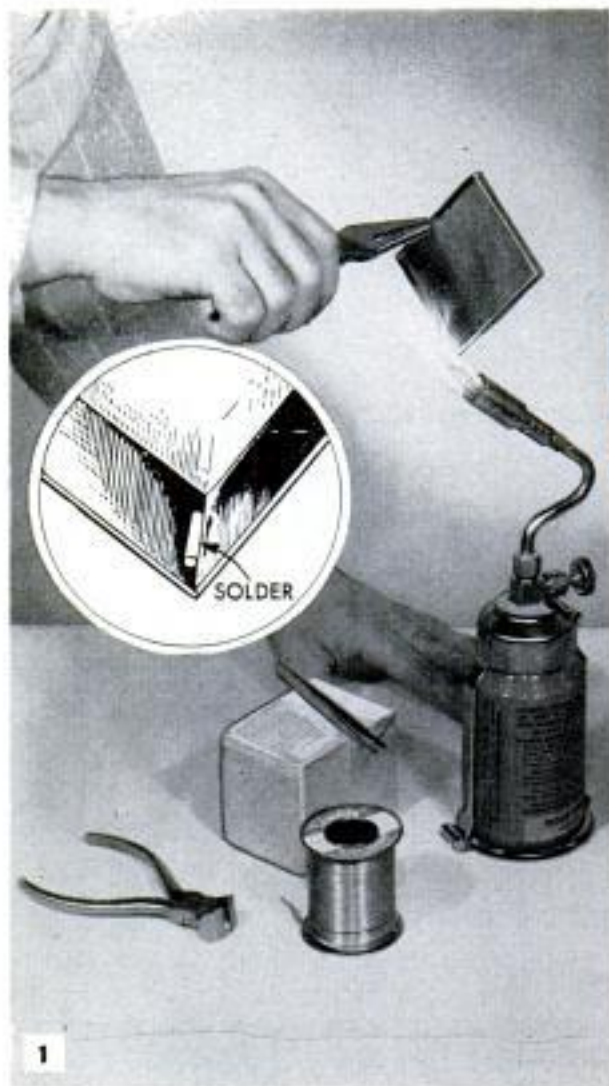

FAST, CLEAN and invariably neat—that's flame soldering on all sheet metals that can be joined with solders, either hard or soft. On small units fabricated of light-gauge sheet metals the joint is formed almost instantaneously. This is always an advantage, especially when a number of small parts must be held in position with clamps or wire.

Equipment required: Soldering equipment for ordinary work is pictured in Figs. 2, 3 and 4. The torch, Figs. 1 and 2, utilizes fuel which is supplied by a detachable pressurized container. Good flame soldering also can be done with an acetylene torch, a Bunsen burner or even a candle. The handiest soft solder for average work is that in the $\frac{1}{16}$ -in. wire form in the 60-40 grade, melting at about 370 deg. F. A 50-50 solder melting at 400 deg. also is practical on certain types of work.

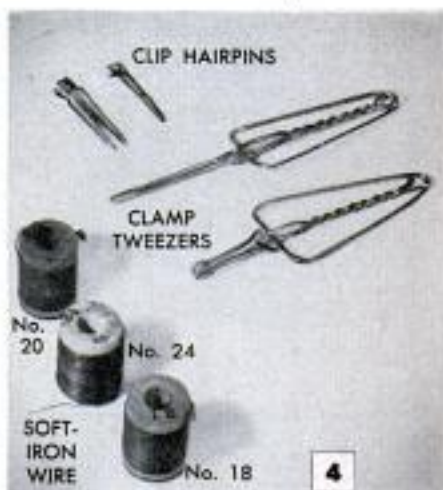
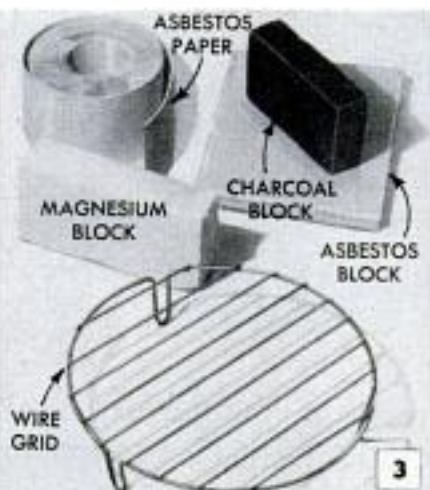

1. FLAME SOLDERING is done with torch of the type furnished with a detachable pressurized container supplying fuel in liquid form. Good flame soldering also can be done with an acetylene torch, a Bunsen burner and even with a candle on light metals

2. BASIC EQUIPMENT includes torch, solder and flux. Solder in $\frac{1}{16}$ -in. wire form in 60-40 grade (60 percent tin, 40 percent lead) is best all-purpose soft solder. Melting point is about 370 deg. F. A 50-50 soft solder also is useful for certain types of work

3. WORK BASES for flame soldering vary according to the type of the work. They must be of asbestos, magnesium or other fireproof material that will reflect heat. Soft charcoal and magnesium blocks permit mounting work with small pins pressed into block

4. HOLDING DEVICES are clips, clamps and binding wire. Weights also can be used on certain types of work. Use only iron binding wire, as brass or copper wire will bond with solders. Clamping tweezers are usually best for flat work. Never use pliers as holders



PRACTICE JOINTS will quickly acquaint the inexperienced operator with the speed and neatness of flame soldering. Flux the joint and place snippets of wire solder along the full length of it. Then heat the metal until the solder flows, or draws, into the joint uniformly

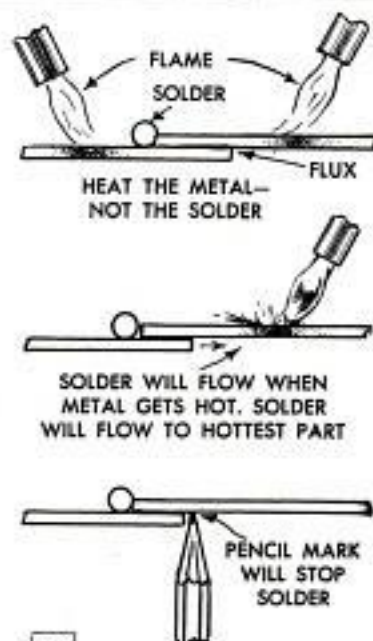
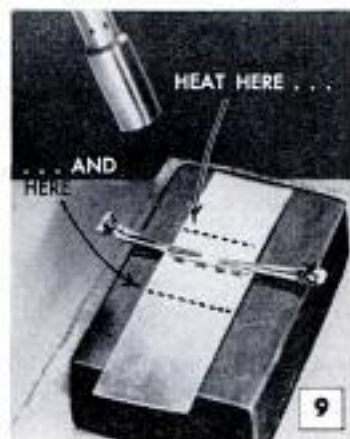
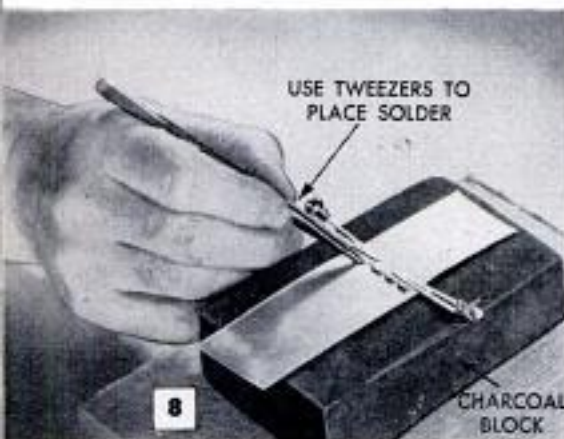

WHEN HEATING to form a soft-soldered joint avoid directing flame on joint or solder. Rather it is best practice to heat adjacent metal from below whenever possible. Keep flame moving continually as the heat is applied, to heat the metal uniformly as otherwise solder will flow to hottest spot

In all soldering, a flux must be used to clean the metal chemically and permit the solder to flow over it. The handiest of all prepared fluxes is that in the liquid form. This is an all-purpose flux and can be used on all metals except aluminum. On some types of work it is necessary to use a flux that will cling to vertical surfaces until the heat is applied. For these jobs, a paste flux is useful. Some users prefer, instead, a paste solder in which solder in granular form is combined with a paste flux. A non-flammable base on which to place the work is easily made by tacking a sheet of asbestos to a block of wood of the size required. However, professional work requires the use of magnesium, charcoal and asbestos blocks like those shown in Fig. 3. For some work, a wire grid is the thing. Several fire bricks also can be arranged to make a suitable work base. Never use iron, steel or other metals for work bases as these absorb heat so rapidly as to make soldering difficult if not impossible.

Lap seam: Figs. 5 to 10 inclusive show the steps in flame-soldering a lap seam. The first step is to cut $\frac{1}{16}$ -in. snippets from wire

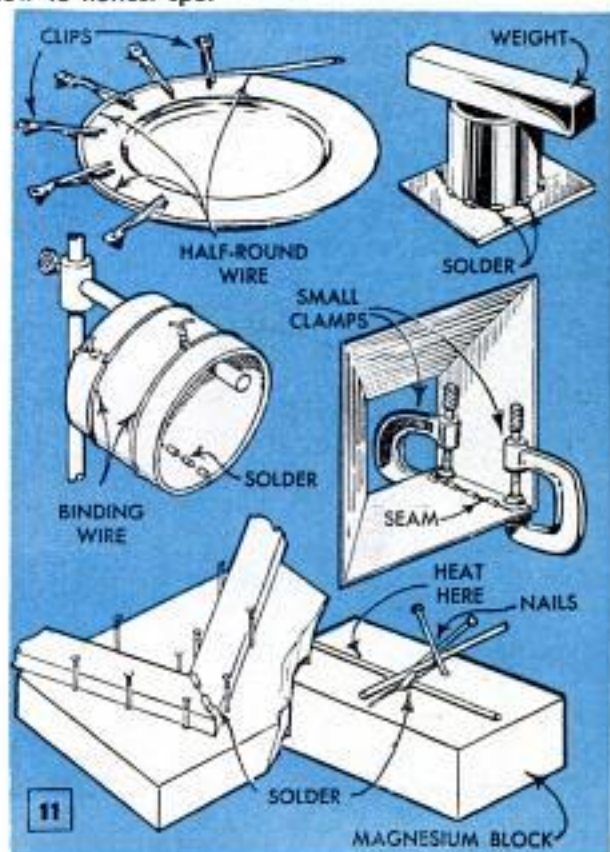

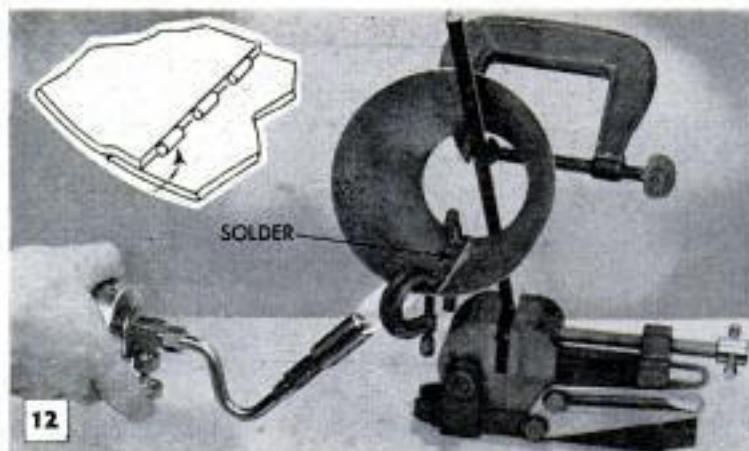

APPLYING FLAME from below permits uniform heating of metal while keeping flame away from the solder itself. Photo at right shows how a wet strip of asbestos prevents softening of solder in seam—already joined. When soldering bottom to cylinder or cone, bottom piece can be placed inside or outside

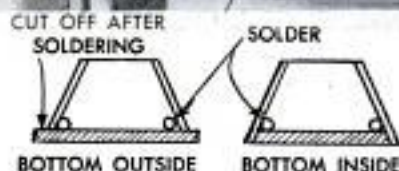

14 BOX LID WITH OVERLAY

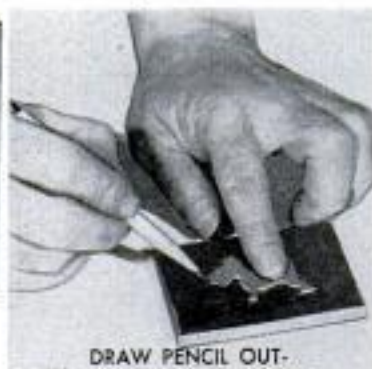

15 DRAW PENCIL OUTLINE AROUND CUTOUT

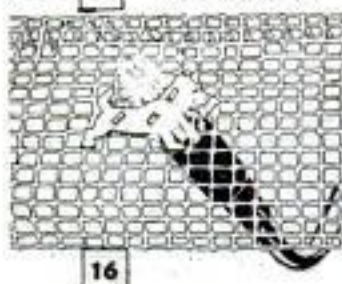

16 TINNING IS OPERATION OF MELTING COATING OF SOLDER ON WORK SURFACE



APPLY FLUX INSIDE PENCIL OUTLINE

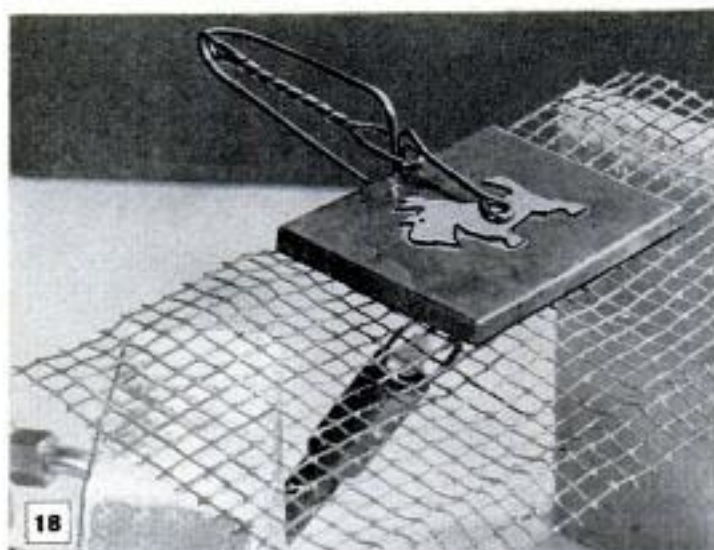

18

solder. Then clean meeting faces of the parts with fine steel wool and apply a liquid flux, Figs. 6 and 7. Clip the parts together or hold down with a weight. Clips are preferable, Figs. 8 and 9. Place the solder snippets along the joint, leaving about $\frac{3}{16}$ -in. space between. Then apply the flame as in Figs. 9 and 10. As soon as the solder melts and flows, withdraw the flame. If you wish to stop solder flow at any point on metal, draw a pencil line at that point. In seam work and certain other operations it's a simple trick to "draw" the solder to any desired area by concentrating the heat at that point. Otherwise it is the best practice to keep the flame moving over the surface of the work so that the metal is heated uniformly.

Cylinder with bottom: Fig. 11 details several examples of work necessary when assembling sheet-metal forms. A rolled-up cylinder or cone with a bottom is typical. The seam is done first, Fig. 12, applying heat from below to draw the solder through the joint. The roll is held in place with soft-iron wire, Fig. 4, while the joint is made. Dampened asbestos paper is used to protect the finished seam when the bottom is soldered in place, Figs. 11 and 13. The bottom can be soldered inside or outside the cylinder or cone as in the detail below Fig. 13. Heat should be applied at the center of the bottom piece and slightly away from the side seam.

Sweat soldering: Figs. 14 to 19 inclusive picture a typical job of



19



20



HARD SOLDERING is essentially the same procedure as soft soldering except that a much higher heat is required, up to 1600 deg. F., to melt silver solders. Flux is made by mixing cake borax with water to make a creamy mixture. Metal must be brought to a medium-bright red and then flame is played directly on joint until solder melts

sweat soldering. Sweating is used where it is desirable to prevent flow of the solder beyond the edges of the joint. First mark around the metal cutout with a lead pencil as in Fig. 15. Then flux the back of the cutout and place it bottom side up on a wire grid as in Fig. 16. Place three to five snippets of solder on the surface, arranging them so that when the solder flows it will cover the surface uniformly. Apply flame from below, moving the flame back and forth or with a slight circular motion to melt the solder uniformly. This operation is known as tinning. Next, apply a paste flux inside the pencil outline as in Fig. 17, making sure that none of the flux extends beyond the pencil line. Then clip the cutout in position and apply heat from below as in Fig. 18. Withdraw the heat when a thin, bright line of molten solder appears at the edges of the cutout. For exceptionally strong joints that must withstand appreciable strain, both parts of the work should be tinned. Small parts also can be sweated together without tinning by using a prepared paste solder.

Hard soldering: Hard soldering is essentially the same process as soft soldering except that the solders used have much higher melting points. Alloys containing silver and brass are used as solders. Silver solders are available in both the sheet and wire forms. Brass hard solders are usually available only in the sheet form. Figs. 19 to 23 inclusive show the process and the equipment needed. Hard solders melt at from 1300 to 1600 deg. F., and for this reason an air-acetylene torch is recommended, as it takes a bright-red flame approaching yellow to melt silver solder effectively. Solder in the sheet form is cut into small squares, about $\frac{1}{16}$ in., as in Fig. 19. The parts to be joined are first fluxed with a mixture of stick borax and water. This is

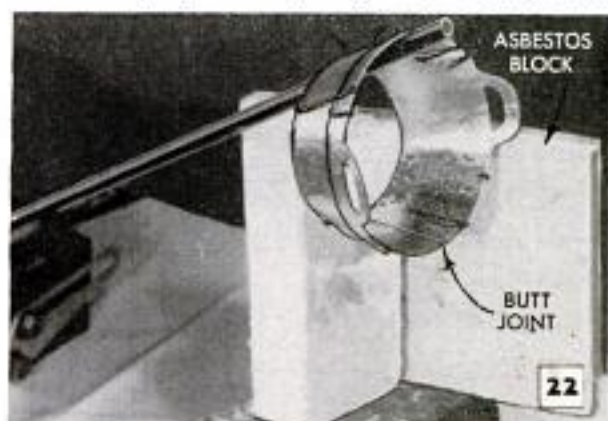

22



23

Charcoal block to which work is wired does not absorb heat in soldering bottom of bucket in place. Asbestos-covered wooden block may be used instead

made as in Fig. 20 simply by rubbing the borax stick on a piece of slate which has been wet with water. After fluxing and placing the particles of solder, heat from below until the metal comes to a medium bright red, then play the flame directly on the joint and solder until the latter melts and runs. Joints must be prefitted as silver and brass solders will not bridge gaps. When possible, use asbestos or charcoal blocks as in Fig. 23 to aid in concentrating heat. Hard-soldered joints will withstand severe strains such as hammering, spinning or other mechanical work. ★ ★ ★

Generator on Power Mower Runs Hedge Clipper



A commercial gardener often encountered the situation of being too far from an electric power source to run his electric hedge clippers. He solved the problem by installing a small 5-amp., 110-volt, A.C. generator on his gasoline-powered lawn mower. After he has finished cutting the lawn and is ready to trim the hedges, he slips off the drive belt of the mower and runs it over the pulley on the generator. With this arrangement, he is independent of the need of an electrical outlet and may run the clippers wherever convenient.

Seed Germination Percentage

The germination percentage of seeds can be determined easily by first punching small holes in a piece of insulating board and forcing a seed into each perforation. Then place the board in a shallow pan containing water. Add sufficient water from time to time to keep the insulating board damp. Percentage can be figured from the number of sprouts.

Test Innertube for Tiny Leaks With Aid of Hand Wringer

To simplify detection of tiny "spook" leaks in car innertubes, one garage attendant dips the partly-inflated tube in water and then runs it between the rollers of an old hand wringer attached to the side of the testing tank. This compresses the air in the tube sufficiently to cause small bub-

bles to appear over the defective area. It's a good idea to run the tube between the rollers several times, changing the starting point each time so that all areas of the tube are subjected to high pressure. The leaks then can be marked and repaired with a patch in the usual way.

Accurately Aligning Dowel Holes Requires Only Carbon Paper

Requiring only a strip of ordinary carbon paper and a rubber band, this idea eliminates the problem of aligning dowel holes in two pieces of wood. First, drill the required number of holes in the end of one of the pieces to be joined. Then fasten a strip of carbon paper on the drilled piece so that it covers the holes. A rubber band will hold the paper and allow you to keep both hands free. Place the two pieces together in the exact position wanted. Give the drilled piece one sharp tap, and the impression from the carbon paper will give location of the dowel holes.

C. L. Barber, Dowagiac, Mich.

Keeping Water Warm in Pail

To keep a pail of water warm for outdoor use during cold weather, set it inside another pail in which a hot brick has been placed. If desired, two bricks broken in half to fit the bottom of the outer pail may be used to keep the water warm for a longer period.

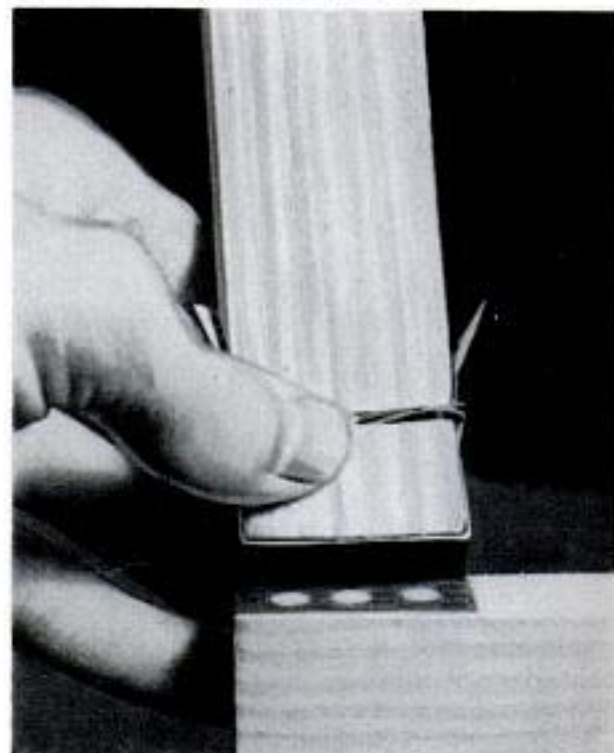

GRINDING JIG for lathe chisels

Leo F. Bowler, Jr.

EVEN EXPERIENCED hands have some difficulty holding the edge of a wood-turning skew chisel to a true bevel when grinding. Some variation is permissible on other lathe chisels but edge bevels on the skew chisel and gouge must be ground accurately. Of the two, the skew chisel is the most difficult to grind correctly freehand and as it is a true cutting, or paring, chisel, the degree of the included angle at the edge is important. A simple jig, made from hardwood as in the details below, does the trick. With only a slight change it can be used either on a circular-saw table, as in the center photo, or on a lathe sanding table, as in the upper photo. In either case, the jig is guided by a hardwood strip screwed to the base piece that slides in the miter-gauge grooves in the saw table and sanding table. The tool holder is inclined at an angle slightly over 17 deg. and the grooves cut into its face give the 30-deg. angle at the cutting edge. The grooves are cut to two widths to accommodate different sizes of skew chisels. Note that the grooves intersect at the center of the holder block so that each size of chisel can be turned over to grind the second bevel. Depth of the grooves is slightly less than the thickness of the chisel blade so that the clamping block will hold it firmly.

Except when reshaping the bevels on a damaged chisel, use a fine-grade grinding wheel, No. 80 or 100. In grinding, set the wheel to take successive light cuts on both bevels. This is done by adjusting the height of the saw arbor, center photo, or adjusting the sanding table as in the upper photo. The gouge is ground freehand as in the lower photo. Simply hold the tool as shown and roll it slowly from side to side.

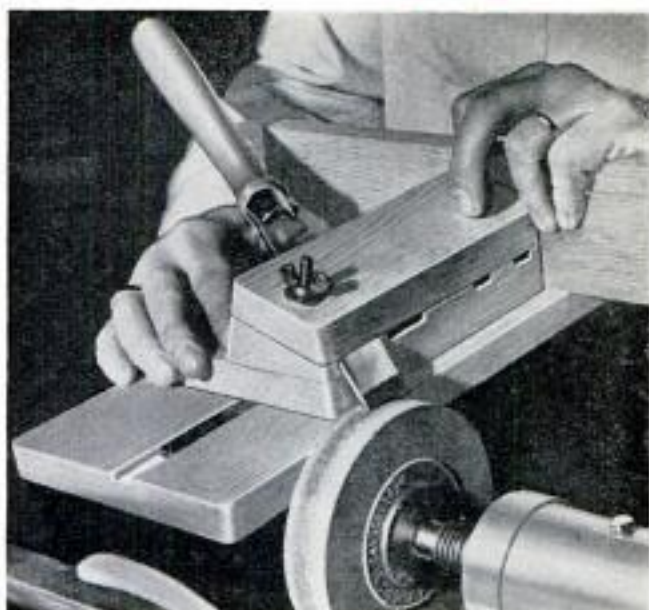

Jig set up on a wood lathe with grinding wheel mounted on lathe spindle. The grinding jig slides on the lathe sanding table, guided by a hardwood strip

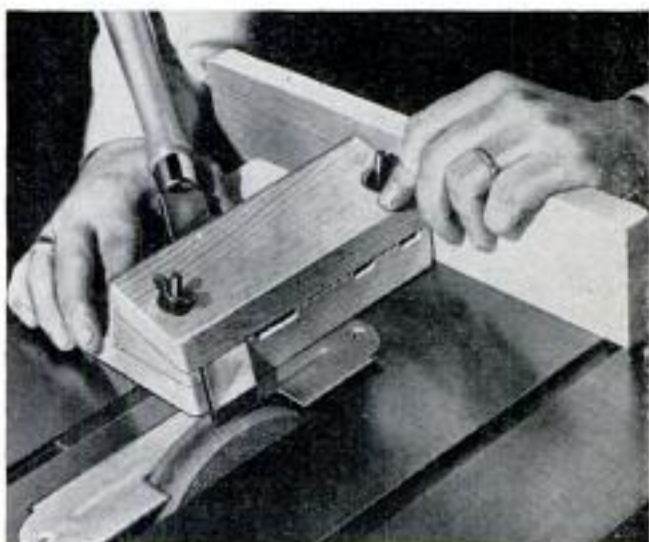

Above, same setup on the circular-saw table. Wheel is adjusted for height by raising saw arbor. Below, gouge is supported on table and rolled freehand

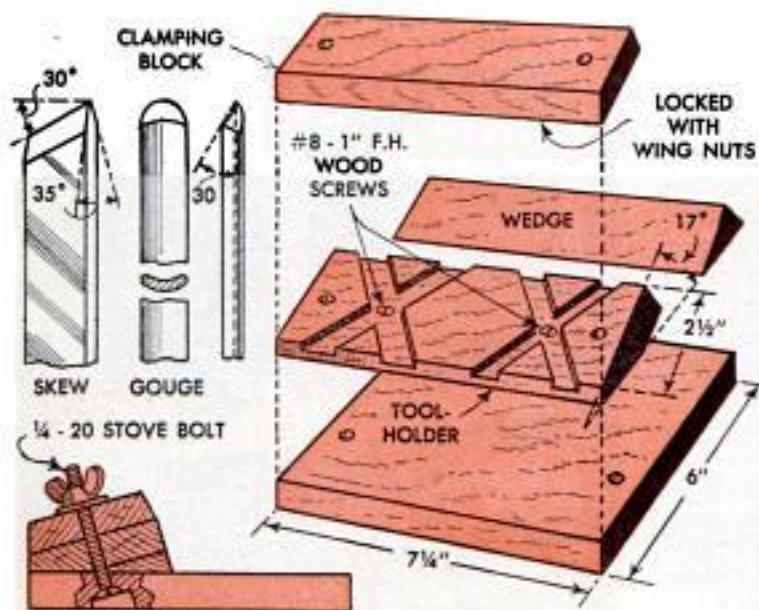



Inking Device on Pantograph Utilizes Refill Cartridge

When mounted on a pantograph, a ball-point pen refill will provide an ideal inking device that glides smoothly in any direction. Simply wind a turn of cellulose tape around the reservoir as shown to hold it in place. The pen refills may be purchased at most drugstores, department and variety stores where fountain pens and supplies are sold.—Frank Shore, New York City.

Hanging of Meat in Smokehouse Speeded by Using Hog Rings



To avoid having to cut and tie twine for hanging hams and bacons in his smokehouse, one farmer simply clinches a hog ring into each piece so it can be slipped over a hook as indicated. In this way, the pieces not only are hung securely but also can be removed easily for testing or storing. Natural oils in the meat prevent the rings from rusting.

securely but also can be removed easily for testing or storing. Natural oils in the meat prevent the rings from rusting.

Machinist's Layout White

A mixture of painter's white-lead-in-oil and carbon tetrachloride makes a good layout paint for use on dark or rusty metal when no commercial product is available. Enough carbon tetrachloride should be

added to the paste white lead to make a very thin solution. The oil must be skimmed off after the solution is thoroughly mixed to assure rapid drying. The mixture is applied with a brush and dries immediately, leaving a flat white surface.

C. Wayne Close, Sycamore, Ohio.

Drill-Press Clamping Kink

To provide a flat surface for the pad of a C-clamp on the underside of a drill-press table, one machinist uses an adjustable jaw or adapter plate in the manner shown. This consists of a steel bar slotted to receive the frame of the clamp at varying depths, a steel pin inserted crosswise through holes drilled near the end of the bar and a leveling screw installed at the opposite end. The pin holds the bar in place, while the screw is adjusted to make the bar level.

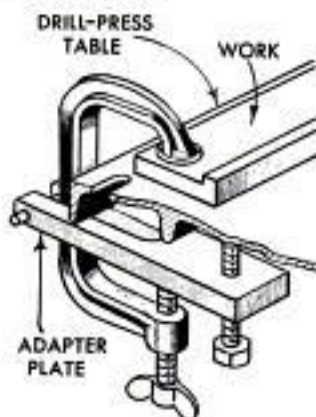

C. H. Willey, Penacook, N. H.

Frame Covered With Fencing Keeps Birds and Eggs Clean

Covered with poultry fencing, this light wooden frame keeps the birds and eggs out of the droppings. It is easily removed for cleaning. The back rail rests on lag screws projecting from the studding of the wall of the poultry house. Bolts instead of nails are used at the corners to keep the frame from twisting. The rails are 2 x 6s and the roosts are 2 x 2s with the tops rounded.

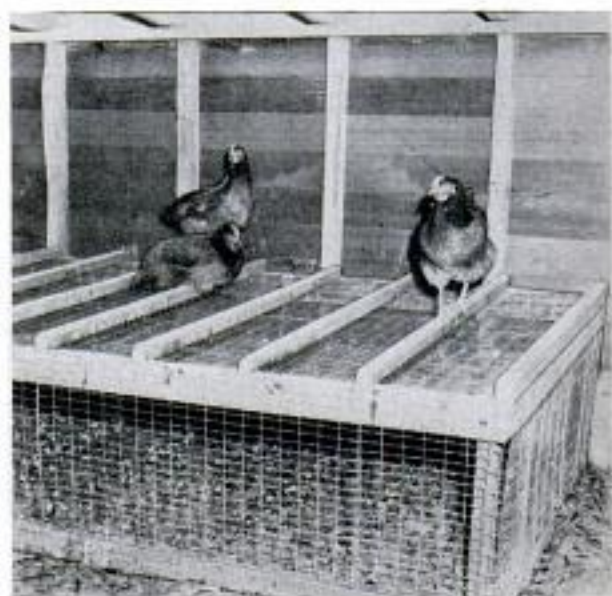

Glass Cutter Held in Lathe Tool Post Scores Bottles Accurately

Cutting sections from colored glass bottles for use in making flower holders, spacers for built-up lamp bases and other novelties can be done accurately in a lathe. Mount the bottle between the lathe centers by using a cupped wooden faceplate for the bottom of the bottle and a tapered wooden "cork" at the other end. Mount a glass cutter in the tool post and adjust it to engage the bottle at a point about $\frac{1}{4}$ in. below the center line of the lathe. In some cases, a lathe dog can be used to hold the cutter as pictured. With the cutter engaged, turn the lathe one revolution by hand. If the cutter "skips" in places give the work one more turn. Wrap a small cord around the bottle at the score, saturate with alcohol and ignite. As soon

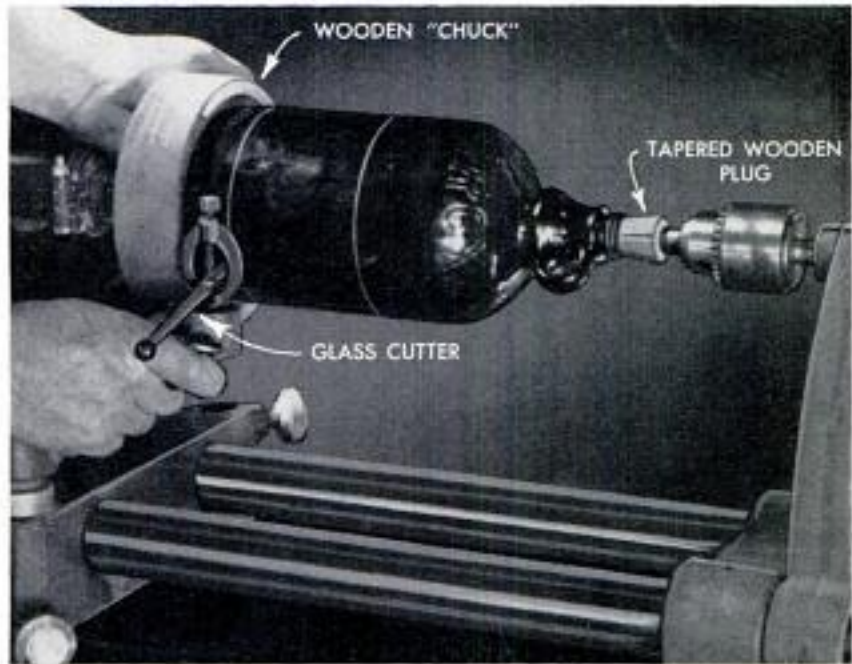

as the cord burns off, remove the bottle from the lathe and immerse in cold water. It will crack uniformly at the score.

W. G. Waggoner, Sacramento, Calif.

"Tow Bar" Is Quickly Improvised From Pipe and Chain

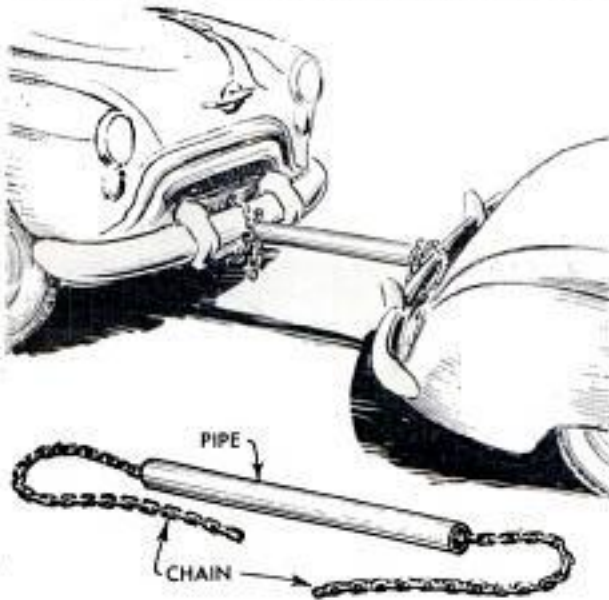

Combining the coupling advantages of a tow chain with the rigidity of a bar, this tow bar can be assembled quickly by any car owner. It consists of a chain threaded through a length of pipe. In use, connect the tow with a minimum of play between the ends of the pipe and car bumpers.

A. V. Malone, Los Angeles, Calif.

Handle for Carrying Vice

One way to make the job of carrying a heavy machinist's vise easier is to clamp the jaws on a 2 x 4 or heavy plank several feet in length. This will provide a handle that will permit two men to carry the vise between them. The handle is also helpful if the vise must be lifted or moved a short distance singlehandedly.

Warren H. Howe, Longview, Calif.

Lathe Center With Driving Pin For Machining Small-Diameter Work

Small-diameter work that must be machined its full length can be mounted between centers on the lathe and driven by a pin, which projects from the end of the live center. The pin is inserted into a corresponding hole drilled in the end of the work. This will eliminate the customary lathe dog, give better balance and allow much higher speeds to be used.

C. W. Woodson, Chicago.

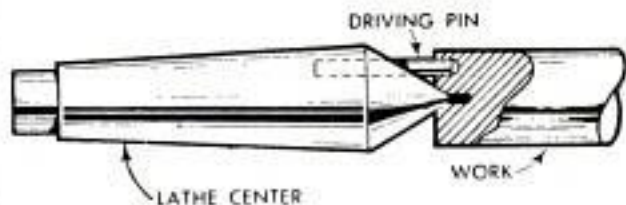

Clear lacquer provides a good coating to protect copper downspouts.



1

SHOPPING FOR TOOLS

1. RUST PREVENTIVE in crystal form gives off a harmless vapor which covers all surfaces within reach with an invisible film that prevents the formation of rust on metal surfaces exposed to high humidity. Items to be protected, such as tools, motors, are stored in drawers or paper bags with a quantity of crystals

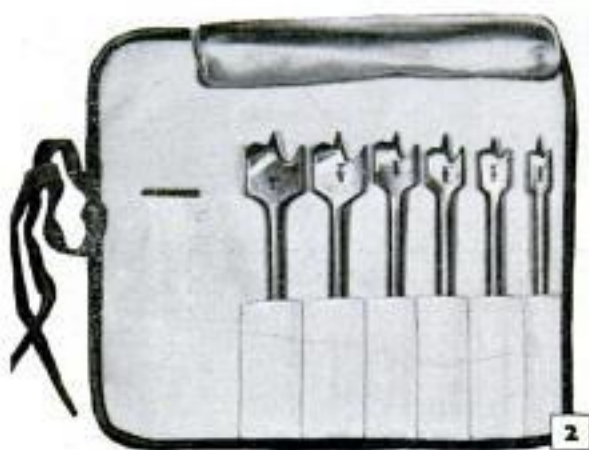

2

2. WOOD-BORING BITS designed for use in portable electric drills have 120-deg. flats on the shanks to prevent slippage. Unusual shape of lip permits cutting edge to sever wood fibers cleanly, resulting in exceptionally smooth holes in hard and soft wood. Comes in four, six and nine-piece sets

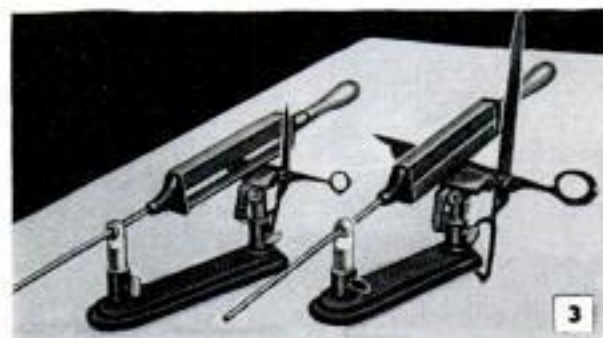

3

3. SCISSOR-SHARPENING JIG for hand-sharpening and honing scissors has a swiveling guide that takes care of the tricky business of maintaining a uniform bevel throughout length of edge. Holder is designed to mount two stones, one coarse and one fine, as in the illustration. Holder also takes a special short file

4. COMBINATION POWER SHOP can be set up as five power tools on a fixed base, the outstanding feature being a circular-saw unit having a tilting arbor for angle cuts up to 45 deg. Tailstock of lathe has 3-in. ram, or quill, travel with lever adjustment. Wood lathe swings 8½ in. and takes 32 in. between centers

5. SOAPSTONE "PENCIL" for welders, plumbers and others who make detailed layouts on sheet metal. Works like an automatic pencil and is designed to prevent breakage of the delicate soapstone "lead." The adjustments permit extending lead any desired distance and provision is made for locking it securely

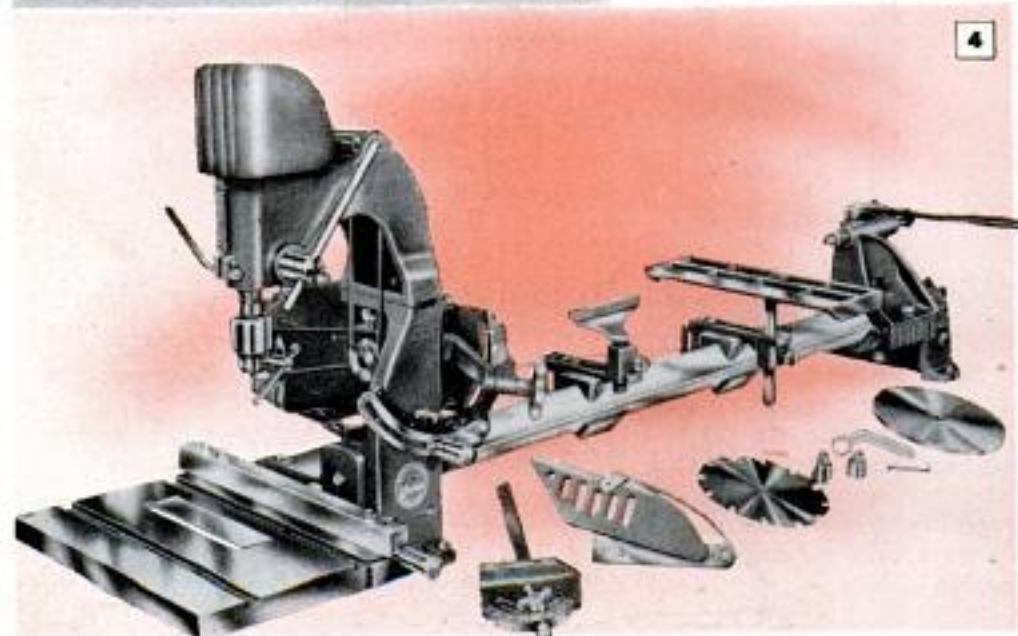

4



5

6. JIGSAW for hobbyist has a built-in motor which drives the blade direct through a rocker-arm mechanism. Cuts 1½-in. softwood. Table raises and lowers and tilts 45 deg. permitting full use of the blade throughout its length. Machine is equipped with a four-way blade holder so that it can be set to cut in any direction without interference from the frame when sawing long stock. Blade guard protects fingers



7. CENTERING PUNCH locates holes to be drilled transversely through round stock, pipe and tubing. Has a swiveling protractor head with scale and level which enables operator to set punch directly on axis of work as in left-hand photo or at an angle as in right-hand photo. Protractor head is of aluminum with accurately machined contact surfaces. Punch is ⅜ in. in diameter, has hardened and ground point

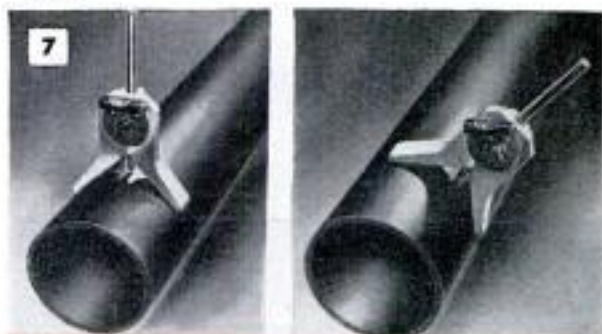

8. ADJUSTABLE DRILL BIT can be adjusted to drill oversize holes for clearance or undersize for press fits. Drills holes from 2 to 4 in. in dia. with two sets of blades. Top photo shows blades extended and lower photo pictures blades in retracted position. Shank is ground to No. 3 Morse taper for use in heavy drill presses, boring mills and turret lathes. Adjustment is made by turning a scroll ring on the body of the drill

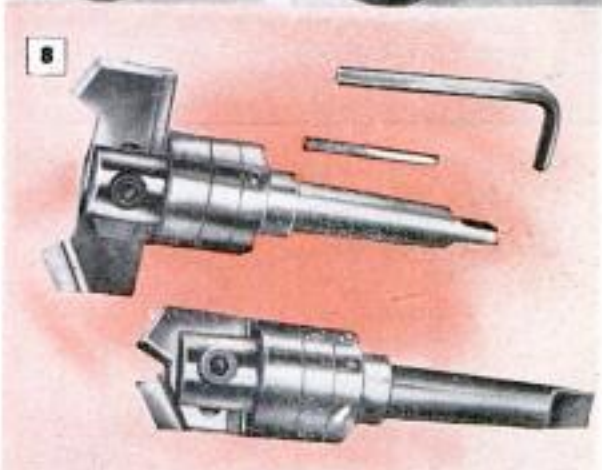

9. FAUCET RESEATER is self-adjusting to faucet seats of various sizes. To use, simply remove the packing nut from the faucet, unscrew the stem and insert the reseater, pressing the arms tightly together so that the pilot, or guide, will enter opening below seat. Then press down firmly and turn in a clockwise direction. There are no separate cutters or other parts to lose as cutters are welded to arms forming handle

10. LEVELING ATTACHMENT for portable electric drills enables operators to drill straight holes either vertically or horizontally. Fits any drill and snaps into place with an elastic band as pictured. Eliminates that "blind spot" so familiar to operators of portable drills. Unit also has other uses. It can be used to level a camera on tripod and also comes in handy when leveling machines for special operations

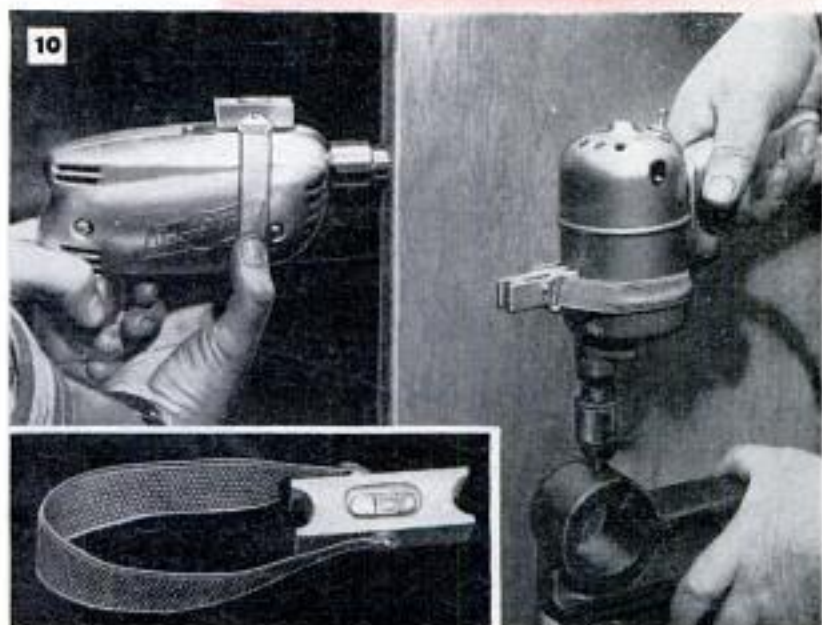
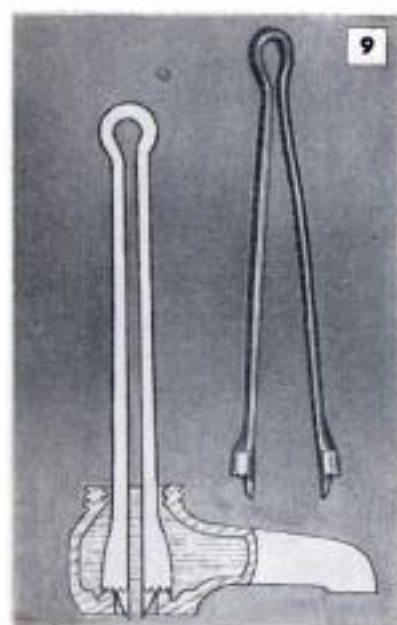

SHOPPING FOR TOOLS

(Continued from page 219)



11. PORTABLE ELECTRIC DRILL has built-in light that focuses a bright beam on the point of the drill bit. Light is built into the gear housing below the drill chuck and the bulb has a vibration-proof filament. Puts light where you want it in those hard-to-see places. Eliminates inconvenience of light extension



12. SPARK-GAP TOOL sets spark-plug electrodes with an accuracy that cannot be equalled by ordinary methods. Takes all standard plugs with gap specifications ranging from .022 to .040. Straightens the side electrode as it is set, thus assuring that the measurement is from the flat face and not from one edge



13. SELF-ADJUSTING PIPE WRENCH fits pipe from $\frac{1}{8}$ to $1\frac{1}{4}$ in. Single movable jaw is pivoted and special shape of work surface of jaw enables it to grip any size pipe within the normal range of sizes for which it is designed. Wrench cannot slip and score pipe when pressure is put on handle to tighten or loosen



14. FLEXIBLE DRIVE TOOL is available either as a screwdriver with conventional blade, or as a socket driver. Shank is flexible; permits driving screws or nuts at any angle up to 90 deg. with the axis of the handle. Gets into places where nut or screw cannot be reached with conventional types of drivers

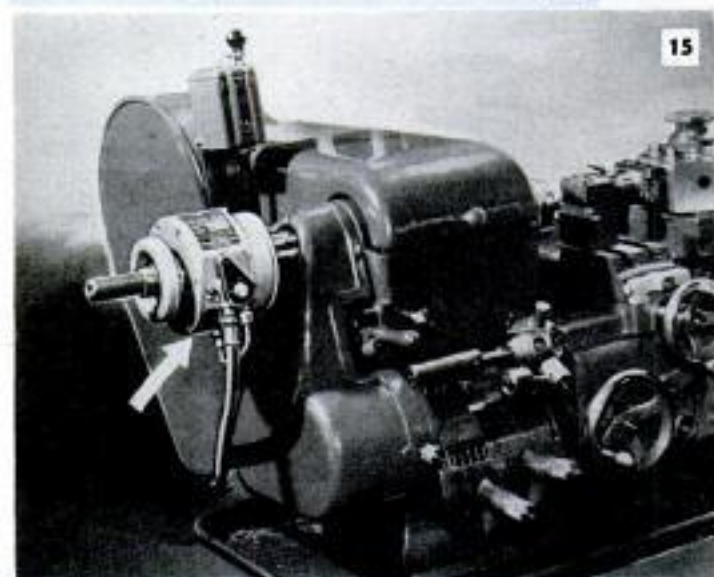

15. COLLET CLOSER is air-operated to give nonstop lathe production on first or second-operation jobs. Adjusts automatically to slight variations in size of stock. Uses any standard draw-type collet and step chucks. Can be operated by hand or foot control, the latter eliminating hand operation entirely



16. HINGE-BUTT MORTISER utilizes a portable electric drill to supply power for the router bit. Consists of a router-bit guide and a jig, or carrier, which clamps to edge of door stile and to jambs as pictured. With the drill and guide in position, a simple movement cuts mortise to correct size and depth

Navy's new radio "Voice"

dedicated to America's security

**WORLD'S MOST POWERFUL MILITARY RADIO TRANSMITTER
A 6-YEAR NAVY-RCA PROJECT!**

On Jim Creek, in the State of Washington, stands the world's most powerful military radio transmitter—its giant antenna stretches from mountain peak to mountain peak.

A 6-year project of the Navy and RCA, "Big Jim" was built and installed to provide the Navy, for the first time, with instant communications with naval units everywhere, on the seas and under the seas, on land and in the air.

Speaking at the dedication ceremonies, Gen. Sarnoff, Chairman of the Board of RCA, said:

"May I express the wish, which I know all in our Armed Services share, that this powerful instrument for transmitting intelligence may add to our national security and to the peace of the world."

The first message flashed by the "Big Jim" transmitter was from Admiral Robert B. Carney, Chief of Naval Operations, to U. S. Navy personnel around the world. He said:

"With this message we forge another link between you and your homeland. With it, we build a new security channel from America to the naval units which form its outer ramparts of defense."



AT DEDICATION CEREMONIES—General Sarnoff operates key to transmit first message, dictated by Admiral Carney, to fleet units around the world.



RCA® **RADIO CORPORATION OF AMERICA**
World leader in radio—first in television



Choosing the right projector for your family color shows

IF you're a color slide fan—or about to be—you know that color slides are rewarding for yourself and enjoyable for your family, too. Yet much of the pleasure you receive depends on the projection device you buy.

Projector, table viewer . . . or both?

Naturally, you don't need a high-powered auditorium-type projector for a small living room. And it takes more than the minimum-powered projector to do a job, say, in a large family recreation room. It's possible you'd be just as happy with a table viewer as with a large picture projected on a large screen. Many color slide fans have both—a projector for a family show, and a table viewer for "quickie"

showings or editing slides in the living room under normal light.

Get a demonstration

When your dealer demonstrates the Kodaslide Projectors and Table Viewers shown on the opposite page, you'll find they flood your color slides with brilliant light, even to the extreme edges of the picture. You'll see each detail crisp and clear, thanks to unique optical systems developed by Kodak optical engineers. And slide changing is easy—even in darkened rooms.

Your Kodak dealer is there to help

Talk with your Kodak dealer about your personal needs—have him demonstrate—and you'll find it's easy to choose the right slide projector or viewer.



Kodaslide Highlux III Projector—Has a brilliant optical system, powerful 300-watt lamp; gives new life to your color slides. Quiet motor-driven blower cools slides. New-type slide feeder in top prevents jarring instrument when changing slides. \$56.50. Highlux II is 200-watt model without blower. \$36.50.



Economy projector—Kodaslide Merit Projector shows your slides with bright, even illumination. Aluminum baffles keep slides cool. Built-in elevation device, easy to operate. Slide-feeding on top prevents jarring instrument. Includes fine Kodak Projection Ektanon Lens, 5-inch $f/3.5$. \$24.65.



For small group showings—Kodaslide Table Viewer 4X combines projector and screen in one handy unit. Enlarges color slides more than 4 times, shows them brilliantly even in lighted room. Only \$37.50.



Deluxe viewer—Kodaslide Table Viewer, Model A, has Day-View Screen for brilliant images. Takes 75 cardboard or 30 glass slides. Push-pull changer advances slides, turns light on and off, restacks slides. \$97.50.

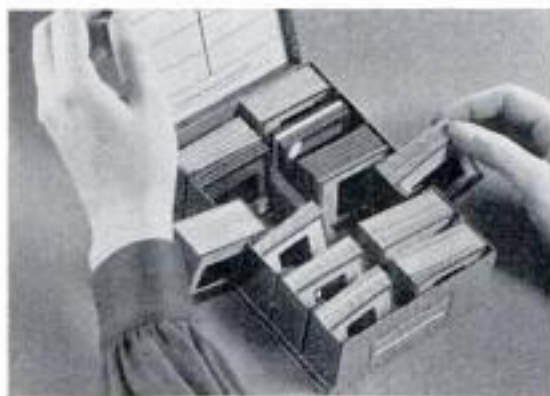

Easy way to store slides—Kodaslide Compartment File has 12 handy swing-out compartments. Stores 240 cardboard or 96 glass slides. You'll appreciate the handy index inside cover for subject reference. \$3.94.



New file for an evening's show—Kodaslide Ready-File is compact, handy for carrying. Holds 200 cardboard 2 x 2 mounts or 100 stereo cardboard mounts. Keeps slides in groups, the way you project them. Index in cover. \$1.95.

Prices are list, include Federal Tax where applicable, and are subject to change without notice

Eastman Kodak Company, Rochester 4, N. Y.

Kodak
TRADE-MARK

Care and Feeding of Engines



BY
S. P. CORP

LOOKING FOR OIL LEAKS

After a long cold winter, gaskets may shrink, bolts may loosen, oil may leak on your garage floor. It is important to locate these leaks and correct them.

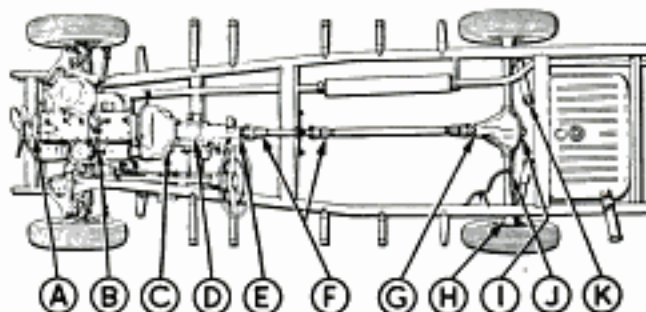

- A. May require a new timing chain oil seal or new oil pan gaskets.
- B. New oil pan gasket.
- C. If engine oil, a new rear main bearing oil seal may be needed. If oil is black and heavy, you may need a new transmission front bearing oil seal.
- D. Transmission oil leaking here may call for a new transmission cover gasket or a new speedometer drive gear oil seal.
- E. Transmission oil here calls for a new transmission rear bearing oil seal—also indicated by oil thrown across the under side of the car body.
- F. You may need to replace the U-joint rubber boot.
- G. Oil leaking from front of rear axle calls for replacing the pinion shaft bearing oil seal.
- H. When inside of wheel is covered with axle oil, the outer end of the axle oil seal needs replacing, lest it cause brakes to grab, which is dangerous.
- I. May require rear axle inspection cover gasket, or merely tightening the plug. If filler plug ferrule is loose in housing, spot welding is needed.
- J. Rear axle oil leaking at hydraulic brake fitting may call for removing brake liner and tightening or replacing fitting; then bleed brakes.
- K. Oil leaking from shock absorber usually calls for replacing the whole sealed unit.

Watch for oil leaks and correct them, as oil can cause costly damage on parts where it doesn't belong.

YOURS FOR THE ASKING



Write for your free copy of the helpful illustrated manual, "MORE POWER, Less Gas, Less Oil." It may save you real money. And when you re-ring, insist on Sealed Power KromeX Ring Sets, with chrome top compression ring, chrome rails on oil ring, and the famous Full-Flow Spring. KromeX Ring Sets are factory-seated for fast break-in and immediate oil control. Sealed Power, Dept. G-3, Muskegon, Mich.

Sealed Power

PISTON RINGS

Clinic for Homemakers



As a service to our readers in solving the hundreds of problems pertaining to a home—inside or out—the editors of *Popular Mechanics* invite you to present your problems to The Clinic Editor for help and advice. Address your questions to The Clinic Editor, *Popular Mechanics Magazine*, 200 East Ontario Street, Chicago 11, Ill.

Sawdust Insulation



Q—I'm planning to build a new home of frame construction with outer walls sheathed and clap-boarded and inner walls lathed and plastered. I want to use sawdust and planer-mill shavings as insulation. However, I'm troubled about the problem of the insulation settling in the walls leaving a space unprotected. How is this prevented?

—G. B., Ore.

A—We cannot recommend the use of sawdust or shavings as insulation in walls. As you have anticipated, the material tends to settle into a compact mass having questionable insulating properties. It also tends to collect moisture, causing rotting of the framing members of the structure. When damp, it does not dry out readily. Although the initial cost of sawdust-shavings insulation may be attractively low, we think that in the long run it will pay you well to discard the idea entirely and use an approved insulating material. This can be one of the batt, quilted or foil type, whatever you choose as being the most convenient to install. We'd suggest that you consider using a batt-type insulation having a vapor-seal facing which is placed on the room side of the wall at the time of installation.

Puttying Sash

Q—A year or so ago I re-puttied the window sash in my home. I allowed the putty to dry two weeks before the sashes were painted. Now the putty is loose in several of the sashes and some of it has fallen out, exposing the glass and also bare wood. The putty strips hardened but did not seem to adhere to the wood. What is the cause and how can I remedy it?

—J. F., Va.



A—Are you sure that the wood was thoroughly dry when the putty was applied? This is such a common cause of the trouble you describe that we are raising the question. It is essential that the wood be dry. Also, it is advisable to prime the wood with paint or linseed oil after the old putty

(Continued to page 226)

No wonder it's called
"Miracle Vinyl-Flooring"!



MATICO ARISTOFLEX

RESISTS GREASE, ACID, ALKALI AND GRIME!

You'll call it "miracle flooring," too, when you see for yourself how rugged, durable MATICO Aristoflex shrugs off household acid, alkali and grease... stays new and sparkling looking with easy damp moppings. Biggest miracle of all is the price! Produced especially to meet the needs of homeowners everywhere, MATICO

Aristoflex is low in cost... gives you more for your money. And you can install economical Aristoflex in every room in your home... from basement to attic. See Aristoflex in 12 rich, clear colors at your MATICO dealer soon. You'll find him listed in your classified telephone directory.



MASTIC TILE CORPORATION OF AMERICA

Joliet, Ill. • Long Beach, Calif. • Newburgh, N. Y.

Manufacturers of:

Aristoflex • Confetti • Parquetry • Asphalt Tile • Cork Tile • Plastic Wall Tile

INSTALL IT YOURSELF AND SAVE!



It's easy! Just mark a straight line through the center of your room in both directions, using a chalk and line. Be careful not to cover up your guide lines.



With a notched trowel, spread adhesive over one-half of your room at a time. leave only a thin coat of adhesive on the floor.



After adhesive becomes tacky, snap the tiles into place. Do not slide tiles or adhesive will push up between the tiles.



Here's the best part! Show your wife your handiwork. (Don't tell her what a cinch it is with MATICO's easy-to-follow instructions).

No Kitchen Odors

SINCE WE INSTALLED OUR

FASCO VENTILATING FAN



AT LAST, an end forever to those annoying cooking odors, messy greases and damaging vapors! Why, our kitchen is a breeze to keep clean . . . and so pleasant now with this beautiful Fasco Fan. . .

DO IT
YOURSELF
AND SAVE!

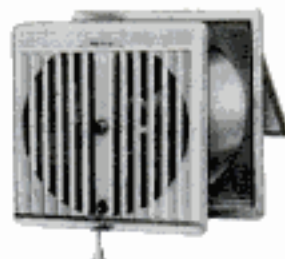

FASCO SHOWS YOU HOW

Start enjoying complete kitchen ventilation the Fasco way today! Simply follow complete step-by-step method in this free and fully illustrated book furnished by Fasco. You'll be amazed how easy it is.

FREE

16 pages of photographs, complete in detail, makes it so easy anyone can do it. Send 10c to cover cost of handling and mailing.

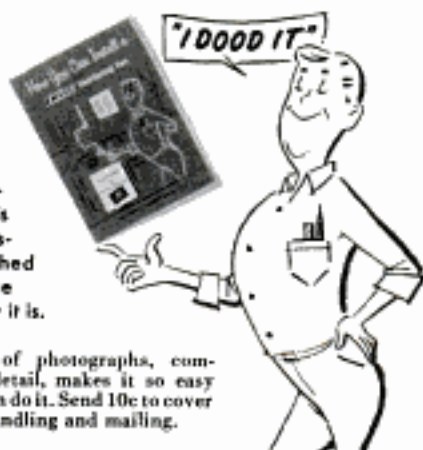

FASCO INDUSTRIES, INC.
20 Augusta St., Rochester 2, N. Y.

Please rush my Do-It-Yourself Book. I enclose 10c to cover cost of handling and mailing.

NAME _____

ADDRESS _____

CITY _____

STATE _____

(Continued from page 224)

has been removed. The primer should be thoroughly dry before new putty is applied. Be sure you have the putty worked to the proper consistency. It should "draw" easily under the knife but should be heavy enough to stay in place without sagging on vertical sash rabbets. Use sufficient pressure on the knife to force it under the edge of the glass pane. The new putty should dry for at least two weeks, preferably longer, before painting.



Reseeding Old Lawn

Q—Last year my lawn was patchy, infested with weeds and in some places moss appeared. The soil apparently is a hard clay and I have trouble getting new seed to root. I do not want to go to the expense of tilling and preparing the area for an entirely new seeding. Can I improve the present lawn?—C. Y., Kans.

A—There is much you can do to improve conditions for the healthy growth of the existing sod but, of course, you can hardly expect to achieve the perfect lawn. This first season set the mower as high as it will cut and continue to cut the grass at this height throughout the season. Soon after growth starts apply a complete lawn fertilizer which is combined with a weed killer. This should be applied with a spreader so that you get a uniform distribution. Several applications will be necessary at regular intervals to get all the weeds and stimulate growth of the existing grass. As the weeds are killed out bare spots will appear. Loosen the soil in these spots with a spading fork and seed heavily. Mix grass seed in with the fertilizer and weed-killing mixture at each application.

Crack in Foundation Wall

Q—There is a horizontal crack running nearly the full length of one wall in my basement. The wall is poured concrete and the crack is at approximately the same level all the way across. It has opened about 1/4 in. in places but so far as I can tell the wall has not tipped inward appreciably. Is there anything I can do to repair this defect?—H. B., Minn.

A—Of course, it is not possible to say with certainty, but we would guess that this crack will not open much more, if any. It undoubtedly was caused by pouring the wall in two stages, with a day or more elapsing between pourings. A crack of the type you have described usually results from this procedure. As a rule, it does not develop into a serious defect structurally, although there is the possibility of water seepage causing some trouble inside the basement. Probably the best treatment is to fill the crack with a masonry waterproofer. Mix a small quantity of this with water to form a fairly heavy paste. Force this into the crack with a putty knife or small trowel and then immediately smooth the material with a brush to conceal the appearance of a narrow patch.

Wood Paneling Over Masonry Blocks

Q—I want to panel an interior wall with knotty pine. The wall is built of light, soft blocks laid up in the same manner as concrete blocks. Can I nail the pine panels, or boards, directly to the blocks? Is there any danger of moisture condensation back of the boards?—S. L., Ky.

A—You can nail the pine boards directly to the blocks, as you suggest, but we think it would be better to nail wooden furring strips to the blocks and then attach the boards to the strips. On an interior wall there is little danger from condensation, but perhaps it is just as well to make doubly sure that no trouble occurs by applying asphalt building paper to the furring strips before nailing the boards in place. Some builders also would prime the backs of the boards with an oil-base paint before installation. Be sure that the furring strips are nailed tightly and that they are of a uniform height above the surface of the wall.

SEE

New Moon

MOBILE APARTMENT HOMES

featured in
M-G-M's
Technical Hit

"The Long, Long Trailer"

Starring

Lucille Ball and Desi Arnaz

AT YOUR FAVORITE THEATRE SOON!

See PHILIP MORRIS CBS TV SHOW 'I Love Lucy'



Learn how you too can enjoy *Carefree Living* ... at a new, low cost

GET YOUR Free Copy

Read how thousands of folks are enjoying new economic security and living freedom in a completely furnished New Moon Mobile Apartment Home.



Newlyweds find New Moon Living the answer to facing an uncertain future with complete confidence. New low cost effects lower living expenses. Complete mobility permits moving to top paying jobs.



Men, whose work requires periodic moving, now take their families with them as they move from job to job. Their New Moon homes make it possible for them to enjoy real family life—and the kids love it too!



Servicemen find New Moon Living makes it possible to keep their loved ones with them, enjoy home comfort near-the-base as they move from camp to camp, and be all set for living after their discharge.



Retired folks rave about New Moon Living as the answer to realizing life-long dreams. They travel, vacation, visit with their families, live North in the summer, South in the winter—in their New Moon Homes.

Your Passport to New Moon living!

Learn all about the advantages of New Moon mobile living—how you can enjoy complete living comfort and convenience in a New Moon mobile apartment home that is completely furnished and available in a variety of sizes to fit your living needs. This colorfully illustrated fact-packed book tells how you, like thousands of folks from all walks of life, can enjoy New Moon ownership at new low cost on our "like-rent" payment plan.

WRITE TODAY FOR YOUR FREE COPY

to: **NEW MOON HOMES INC.**
Alma 40, Michigan

WITHOUT OBLIGATION, please send me a free copy of "Planning Guide," describing the advantages of New Moon Mobile Apartment Living.

Name: _____

Address: _____

City: _____ State: _____



YOU TAKE YOUR HOME WITH YOU WHEREVER YOU GO ••• FOR SEMI-PERMANENT LIVING, TRAVEL AND VACATION FUN!

TIME SAVING TIPS

ALL YOU NEED IS A TUBE OF

DU PONT DUCO CEMENT

REG. U. S. PAT. OFF.



CAMERA EXPOSED? Peeling leatherette on cameras, binoculars and other equipment can be mended like new with "Duco" Cement.



RIDING A HOBBY? Maybe you make toys, scale models—build 'em for the fun of it. Use fast-drying "Duco" Cement.



LEAKY AQUARIUMS call for quick, dependable repairs. A dab of waterproof, transparent "Duco" Cement seals leaks easily.



LEAKY TENTS can spoil camping fun. Waterproof, flexible "Duco" Cement seals tiny holes... prevents them from enlarging.



TORN BASEBALL MITTS can stay in the game longer when leather is repaired with strong, flexible "Duco" Cement.



CRACKED LENSES on flashlights will hold fast until they're replaced, when you mend them with transparent "Duco" Cement.



TORN WALLPAPER need not be a household catastrophe. Just mend it neatly, quickly with handy "Duco" Cement.



REPLACE FELT on bases of candlesticks, vases, and bric-a-brac—to protect finish of tables. Use Du Pont "Duco" Cement.



NEW EASY-SEAL TOP HAS HANDY APPLICATOR TIP



BETTER THINGS FOR BETTER LIVING
... THROUGH CHEMISTRY

REG. U. S. PAT. OFF.

The Sub That Can Lick a Plane

(Continued from page 126)

the only person looking through the periscope when the submarine is submerged and everything is dependent upon his judgment.

Skirting fishing fleets and diving from planes searching for him, the skipper "conns" the ship towards the assigned station. At last that day arrives and then comes a period of tenseness in which the radar picket must surface and establish contact with the carrier striking forces. The first thing that our submarine picket gets on his radar screen is an incoming flight of planes bent on destroying the task forces moving in.

Back in the air-control center, a room unique to pickets between the conning tower and the after-torpedo room, an operator spots the planes and speaks into a UHF or VHF set: "Bogies, seven or eight in number, bearing 045, range 40 miles, closing fast."

This information flows to the carriers of the task force and there orders bawl out: "Pilots, man your planes." Combat air patrols, hovering above the carriers, are already on the way to meet the attack.

The skipper of the picket hears this by monitor. The operator broadcasts his information direct to the task force without checking with the skipper. Time doesn't allow it. In the jet age, forty miles is only two "breaths" away.

The picket continues to broadcast information as she spots enemy air movement on her radarscope.

How can the radar picket fit into the total radar defense of the United States other than by her assigned role of watchdog for the operating carriers?

The answer, again, is simple. In event of future wars these stealthy boats could arrange themselves off an enemy coast and relay movement of high-flying aircraft back to the States. Since the broadcast range would necessarily have to be short, a veritable chain of these boats would be needed as a supplement to our coastal radar defenses.

The submarine has its greatest advantage in adaptability. It can now launch guided missiles. It has already proved its worth in plundering enemy shipping and in the humanitarian chores of pilot rescue and evacuation. It can drop frogmen close to enemy shores.

Now, a new role has been added in the radar picket. Subs were second best in fighting aircraft surfaced, but now the radar picket can lick a plane without even firing a shot.

★ ★ ★

Snap-Tite

REG. U.S. PAT. OFF.

ADJUSTABLE STOPPERS

STOP...

**LOSS OF — HEAT • COLD • FLAVOR • TASTE • FRESHNESS
• AND ELIMINATE LEAKY CORKS**



No. 25

Fits regular-size vacuum bottles

25c



No. 15

Fits beverage bottles

15c



No. 40

Fits regular ALADDIN vacuum bottles

40c



No. 52

Fits ALADDIN wide-mouth 10-oz. vacuum bottles

50c



No. 50

Fits THERMOS spoon-mouth bottles. In 10-oz., pt. & qt.

50c



No. 70

Fits UNIVERSAL and THERMOS pt. size wide-mouth food vacuum bottles

70c



No. 80

Fits ALADDIN wide-mouth pt. & quart vacuum bottles

70c



No. 75

Fits UNIVERSAL and THERMOS qt. size wide-mouth food vacuum bottles

75c



No. 79

Fits PICNIC JUGS

79c

**AVAILABLE FOR ALL
POPULAR MAKES OF
VACUUM BOTTLES
PICNIC JUGS
BEVERAGE BOTTLES**

Snap-Tite Adjustable Stoppers will save money for you by keeping food and beverages fresh, hot or cold longer — makes an air-tight seal. It's the easy-to-use adjustable feature that makes this possible. A twist with the fingers makes Stopper larger or smaller to fit size of opening. Ask your dealer for Snap-Tite or write.

Snap-Tite

MOELLER MFG. CO., INC.

Dept. PM, 2401 Durand Ave.,
Racine, Wis.

In Canada

Moeller Mfg. Co. (Canada) Ltd.
Niagara Falls, Ontario

Canada

Prices slightly higher in Canada.



We manufacture special stoppers for industrial applications. Send details for prompt quotation.



...When you use
these WIZARDS with WOOD!

Down at your hardware, paint or lumber dealer's are 3 magical products for mending things, making things, finishing things. Mail coupon for everything you want to know about Weldwood Glue, Firzite and Satinlac.

Gets that blond or pickled effect—



Produces those magical "woody" effects—on hard wood or soft, plywood or solid lumber. For light pastel tones, tint White Firzite with Colors-in-Oil. (On fir plywood stain jobs, tame that wild grain with Clear Firzite.)

WHITE FIRZITE®

Gets that Natural-Wood Finish



— without shellac or varnish. On furniture, panelling or woodwork, there's nothing like Satinlac. Brings out natural grain and color beauty of any plywood or solid wood. Avoids that "built-up" look. "Water-clear," easy to brush or spray, dries ready for next coat in 2 or 3 hours.

SATINLAC®

The Wood Glue you can rely on!



To make things or fix things, use Weldwood Glue for all wood-to-wood bonds. Makes joints stronger than the wood itself. Mixes easily with water. Stain-free, rot-proof...highly water-resistant!

WELDWOOD®
 PLASTIC RESIN GLUE

United States Plywood Corporation,
 Dept. 306, 55 West 44th St., New York 36, N. Y.

Send me free leaflets on Weldwood Glue, Firzite and Satinlac.

NAME _____

ADDRESS _____

How to Produce New Ideas

(Continued from page 106)

an attempt to send telegraph signals from a rotating disk—which he noticed gave a resonant hum at high speeds. In 1877 he developed a modified funnel through which vibrations of the voice operated a pawl and ratchet wheel. Tinkering with what seemed a useless toy, the inventor suddenly connected it with his disk experiments. Combining elements from the two devices, he came up with the talking machine. Had Edison not had a problem lying dormant, mere experiments with the voice funnel would not have led to the phonograph.

Creativity seems to depend upon a sudden fusion of elements already familiar in experience. An experiment in chemistry provides an analogy. Take a supersaturated solution of sodium thiosulphate and examine it; it has all the properties of a liquid and no characteristics of a solid. Drop just one crystal into the solution, and with a rush of molecules the entire solution will suddenly solidify in crystalline form.

Unsolved problems, stirred in the mental hopper long enough, tend to become supersaturated. When that stage is reached, introduction of a single pertinent new factor may cause crystallization or "inspiration."

Especially in the case of major originators, the number of new ideas produced is as startling as their range. Leonardo was almost equally proficient as a painter, mathematician, architect, engineer, sculptor, psychologist and physicist. He himself regarded his military work as equal to his works of art. Leonardo studied optics and devised a theory of three-dimension vision. He originated the science of hydraulics. Botany, anatomy, geometry and natural history vied for his time and attention. Yet his first major job was as a professional musician. He invented a rapid-fire cannon, a time fuse, harbor dredge, screw-cutting machinery, a diving bell and a rolling mill. He conceived of using the propeller for motive power and devised models of a submarine.

Ludwig von Helmholtz was a military physician, physicist, anatomist, mathematician and physiologist. His discoveries ranged from measurement of the velocity of nerve impulses to the principle of conservation of energy. He made major advances in electrodynamics, fundamentals of geometry, vortex motion of fluids, optics and philosophy. Printer-diplomat-writer Benjamin Franklin invented the lightning rod, bifocal glasses, the Franklin stove and a clothes mangle. He founded the public library system, the national postal service

(Continued to page 234)

GRAVELY

More
for your
Money!



GRAVELY MAKES TOUGH JOBS EASY!

Gravelly does jobs other tractors won't . . . because Gravelly has that *extra* power you need for the tougher mowing, gardening, field and farm jobs. Does a better job, even on *steep slopes!*

You get *more* when you get Gravelly. All-gear drive, power reverse, simple operation. More traction from easy-handled, *balanced* weight. Power attachments quickly interchanged, *securely* mounted, with only four bolts!

See Gravelly's rugged, compact, completely functional design. Not merely assembled, but completely manufactured by specialists who make only Gravelly Tractors and their attachments.



5-HP

SINCE
1922

PLUS . . . 21 JOB-RIGHT TOOLS!

Your choice of 21 tools for a versatile tractor that saves time, work and worry *all year long*. Tools to do every mowing, gardening, field and farm job.

Send coupon today for "Power vs. Drudgery", the big booklet that shows how Gravelly equipment solves your upkeep and gardening problems . . . *faster, easier, better!*

GRAVELLY TRACTORS, INC.
BOX 363 DUNBAR, W. VA.

Please send me "Power vs. Drudgery" Booklet and dealer's name.

NAME _____

ADDRESS _____

CITY _____ STATE _____



CULTIVATE



MOW WEEDS



SAW
TIMBER,
FIREWOOD



MOW
LAWNS



BLOW
SNOW



MOW
LAWNS, WEEDS,
MULCH
LEAVES



HAUL

FREE

MAIL TODAY

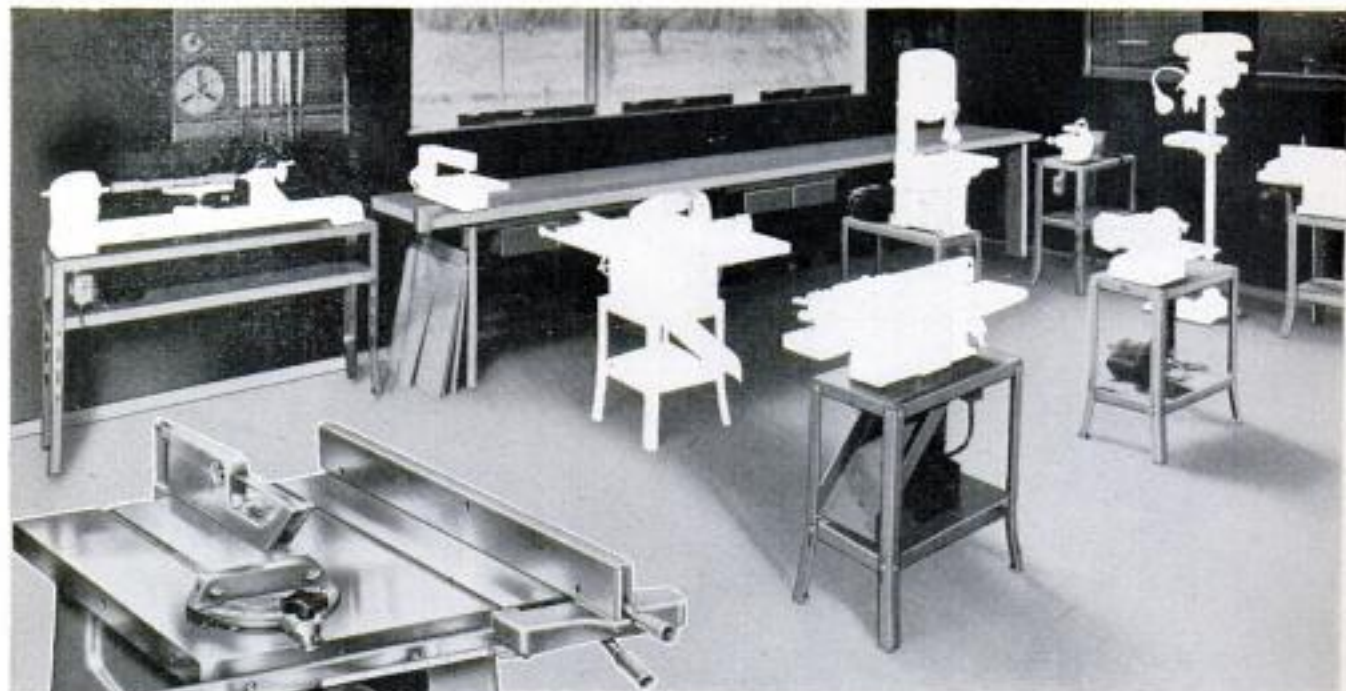

**No. 3021
Circular Saw**

STYLED BY
HARLEY EARL
DESIGNERS

**WRITE FOR COMPLETE
WOODWORKING POWER
TOOL CATALOG . . . FREE!**

ATLAS PRESS COMPANY

324 N. Pletcher Street, Kalamazoo, Michigan

Please send free catalog of ATLAS Woodworking Power Tools and the name of my nearest ATLAS Franchised dealer.

Please send me a copy of 18 OUT-DOOR EQUIPMENT WOODWORKING PLANS, garden and porch furniture and accessory plans by outstanding authorities. I enclose 50c (65c outside U.S.A.)

NAME _____

ADDRESS _____

CITY _____ STATE _____

Even if you have a saw, you should see **THESE TWO GREAT NEW ATLAS TILT/ARBOR, BALL BEARING CIRCULAR SAWS... 8" No. 3021... 10" No. 3061**

They're brand new from top to bottom . . . the saws of tomorrow setting new shop standards today. **TEN NEW FEATURES** combine to make them more rugged, easier to handle, quieter, smoother and more accurate than any previous saws, at any price. Just look at these "plus values": **NEW** modern structural design . . . **NEW** push-pull dual blade control . . . **NEW** larger arbor and sealed-for-life ball bearings . . . **NEW** famous ATLAS double-locking, lift-off fence . . . **NEW** dual V-belt drive . . . **NEW** grip-form miter gauge . . . **NEW** big, easy-to-read tilt gauge . . . **NEW** structural design mechanism . . . **NEW** clear-vision safety guard . . . **NEW** pyramid design stand. America's newest and finest circular saws sensationally priced . . . No. 3021 8" saw only \$87.50* less motor, guard, stand—No. 3061 10" saw only \$139.75* including guard.

SEE YOUR ATLAS FRANCHISED DEALER TODAY . . .
he's the man who knows power tools . . . let him help you get the most out of your home shop.

you can DO so much MORE

FILL IN THE "BLANK SPOTS" IN YOUR SHOP WITH...



Atlas POWER TOOLS

America's Finest

Here are the power tools you need to complete your woodworking shop . . . the finest power tools available, built to the same exacting standards that have made ATLAS Machine Tools the leaders of the industrial field for over 40 years. Each one is the outstanding value in its class . . . you'll be proud to own ATLAS Power Tools.



NEW . . . THE SMOOTHEST 24" JIG SAW EVER . . . every part of this saw is newly designed to minimize vibration and promote smooth, clean, accurate cuts. Tremendous capacity . . . handles wood, metal, plastics . . . cuts up to 2 1/4" thicknesses . . . blade turns 90° . . . arm is removable . . . massive 14" x 14" precision ground tilt table . . . four speeds . . . sealed-for-life ball bearings . . . spinning blade support . . . complete splash lubrication . . . exclusive spring steel hold-down. No other jig saw compares with the new ATLAS No. 4002 . . . only \$84.75*



6" JOINTER-PLANER . . . you'll be thrilled at the "professional look" you can give your work with this tool . . . tight fitting joints, perfect rabbets, glossy smooth surfaces, accurate bevels and tapers. Massive construction with 10 pound cutter head . . . tops for accuracy and ease of operation. Only \$129.75*



DRILL PRESS . . . takes the hard work out of dozens of jobs . . . drilling, boring, carving, sanding and shaping . . . it routs, carves, cleans, buffs, polishes and even mixes paint. Bigger ATLAS head, exclusive floating drive, sealed-for-life ball bearings and other exclusive features make this today's best drill press buy. Prices start at \$87.00*

ATLAS OFFERS TOOLS TO FIT EVERY NEED AND EVERY PURSE. See the ATLAS WORKSHOP line . . . quality power tools at budget prices. For example, the Workshop No. 9340, 13" Jig Saw, costs only \$24.75.*

so much **BETTER** with



GRINDER-HONE . . . something absolutely new, not just a grinder, but a rotary hone as well . . . sharpens knives, tools, drills, garden implements and household utensils to a perfect razor edge . . . also sands, buffs, polishes and cleans . . . a real workhorse. 5" reversible oilstone (120-320 grit) turns at 110 RPM while 6" all-purpose grinding wheel spins at 3000 RPM. Only \$31.50*



12" BAND SAW . . . you'll wonder how you ever got along without it . . . cuts thick lumber or multiple pieces, makes smooth outside curves and does many heavy jobs no other tool can do. Sealed ball bearing construction, both for wheels and blade supports . . . tilt table supported by rugged trunnions . . . extra heavy construction throughout . . . big capacity. Only \$105.00*



BELT AND DISC SANDER . . . for beautiful finishing without back breaking, time consuming hand work. Big 10" diam. sanding disc . . . large sanding belt operates in vertical and horizontal positions . . . table tilts 45° . . . sealed-for-life ball bearings. Only \$81.75*



SPINDLE SHAPER . . . makes fancy furniture trim, molding and beading . . . a necessity for door and window work, home "finishing", cabinet making. Stationary spindle with sealed ball bearings . . . 15" x 21" precision ground table moves up or down 2" . . . integral motor support. Only \$82.50*



12" LATHE . . . for turning bowls, plates, lamps and legs for tables, chairs, beds, etc. Ball bearing construction . . . 36" capacity between centers . . . lever controlled bed locks . . . 60 hole indexing system . . . four speeds . . . rugged precision construction for smooth accurate work. Only \$89.75*

*Prices slightly higher west of the Rockies.



Atlas Press Company

ATLAS WOOD WORKING POWER TOOLS
ATLAS METAL WORKING MACHINE TOOLS
CLAUSING HEAVY DUTY MACHINE TOOLS

NEW PRINCIPLE OBSOLETES ALL OTHER SHOCK ABSORBERS

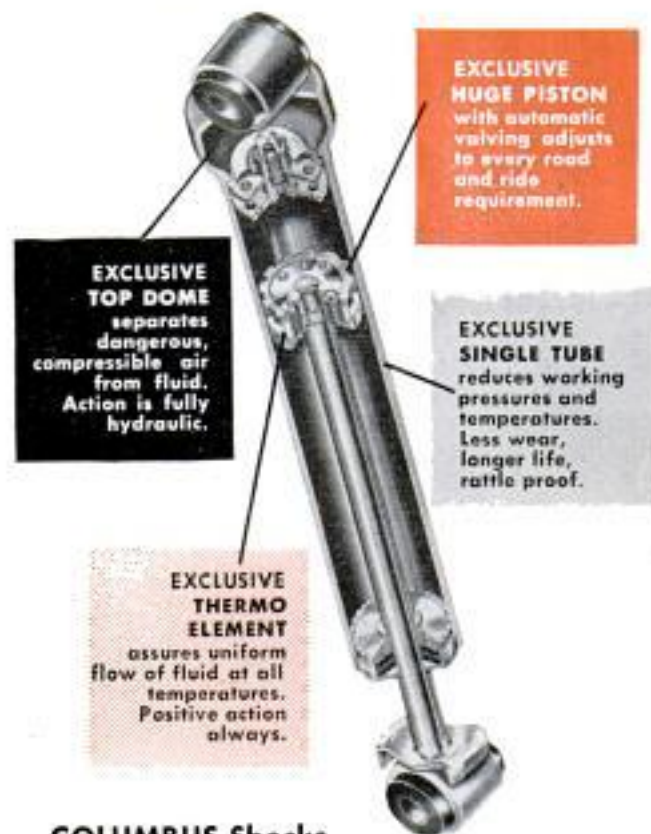

COLUMBUS Shocks

embody the only major improvements in design and construction since the airplane type was introduced.

COLUMBUS gives an improved ride never before possible with ordinary conventional shocks. Columbus gives greater car control because it compensates more fully for sudden road changes. This means a safer ride for you and your family.

"SAFETY KNOWS NO SEASON"

Write for free booklet...

explaining in detail the new principle of Columbus Shock Absorbers. Discover the facts about America's Safest Shock Absorber NOW.

HECKETHORN MFG. & SUPPLY CO.

Dep't PM • 242 West Main Street,
Littleton, Colorado



COLUMBUS
Luxury-ride SHOCK ABSORBER

MADE BY
HECO

and the basis for modern life insurance.

Absorbing interest in many diverse problems marked the careers of such men as Edison, Ford, Westinghouse, Steinmetz, Marconi, Morse, Watt, Newton, Galileo, Einstein, Faraday and Pasteur. It must not be forgotten that all these giants failed in many of their undertakings. Their numerous successes are partly due to the fact that they were eternally seeking, probing, puzzling—working on a wide variety of problems simultaneously.

Obviously you won't become an Edison or a Newton merely by employing the four principles discussed here. But on a scale in keeping with your native ability, training and environment, you can produce new ideas. To do so, cultivate passionate interest in problems. Approach them with an open mind, fed from several diverse fields of inquiry. Give the little-known mechanism of "inspiration" a chance by deliberate change of pace, working meanwhile on numerous and varied projects. ★ ★ ★

Plastic Window Frame Offers More Glass Area

Sturdy and durable is a new window frame made of plastic. Unlike other frames, it will not shrink, swell, rot or rust and never needs painting or refinishing. A glazing strip eliminates the need for putty. It costs no more than a wooden frame and offers 25 percent more glass area in a given opening. A package unit ready for installation includes a combination screen and storm sash. Rustproof metal fittings and aluminum or spring-bronze weather stripping complete the unit.



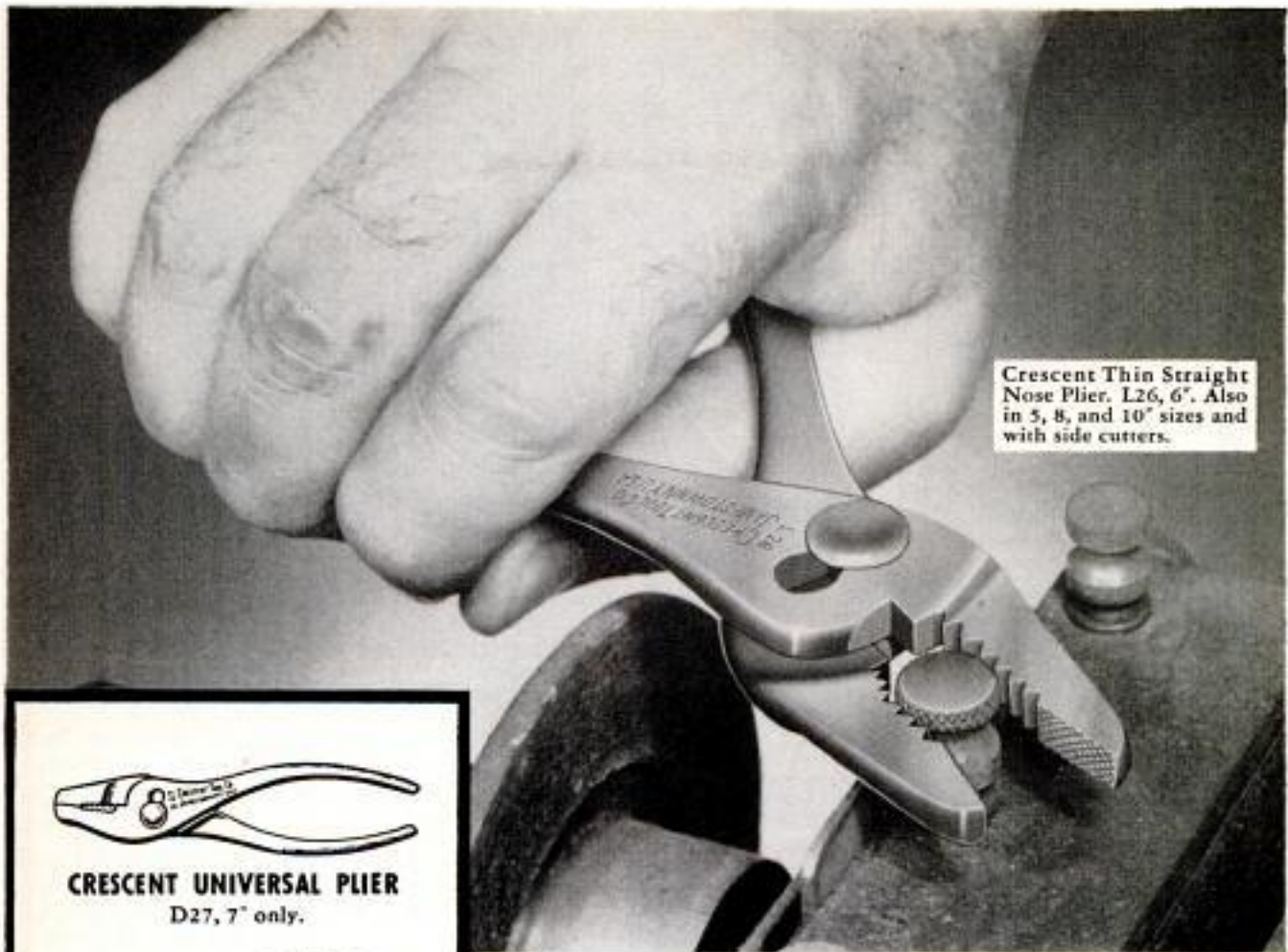

Crescent Thin Straight Nose Plier. L26, 6". Also in 5, 8, and 10" sizes and with side cutters.



CRESCENT UNIVERSAL PLIER
D27, 7" only.



MoToR KiT COMBINATION PLIER
G25, 5". Also in 6, 8, and 10" sizes.



CEETEECO COMBINATION PLIER
H25, 5". Also in 6, 8, and 10" sizes.



CRESCENT THIN BENT NOSE PLIER
J26, 6" only.

CRESCENT SLIP JOINT PLIERS

Crescent offers a wide selection of styles and sizes in this widely used plier type. All are drop-forged from special analysis steel and finished in bright plate. They have sharply milled teeth, comfortable handles and smooth working joints. The joint bolt and nut are turned from solid bar steel and case hardened. Sold by Industrial Distributors and Hardware Dealers everywhere.

CRESCENT TOOLS

Give Wings to Work

*Sign of the Artisan
Symbol of Excellence*

®



Crescent is our trade-mark, registered in the United States and abroad, for wrenches and other tools. Sold by leading distributors and retailers everywhere and made only by **CRESCENT TOOL COMPANY, JAMESTOWN, NEW YORK**

SAFE LUBRICATION

PENNZOIL

THE *Tough-Film* MOTOR OIL

100% PURE PENNSYLVANIA

SAVE OIL and ENGINE WEAR with this LONG QUART

This 100% Pennsylvania motor oil with THE *Tough-Film* stands up under intense heat, resists formation of oil-wasting engine deposits. Your engine stays clean, smooth-running, uses less oil. And because Pennzoil lasts so long, it guards against costly wear caused by acids and friction. Switch to Pennzoil now!

As big a difference as ever!

Most motor oils now contain detergents. A detergent's job is not to lubricate, but to improve conditions under which oil lubricates. Pennzoil, too, contains detergents, but its basic lubricating quality, resulting from superbly refined Pennsylvania crude, still provides an extra margin of safety.

Sound your Z at this sign...



© 1954, The Pennzoil Co. Member Penn Grade Crude Oil Assn., Permit No. 2
BETTER DEALERS IN EVERY STATE FEATURE PENNZOIL MOTOR OILS & LUBRICANTS

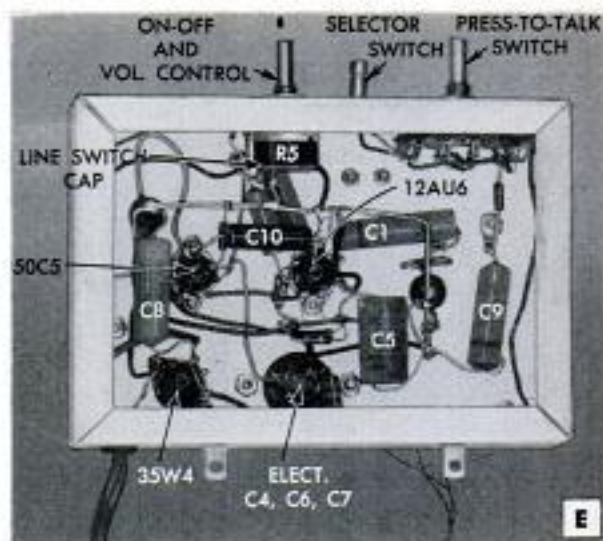

1954 "Little Giant" Low-Cost Multistation Intercom System

(Continued from page 159)

double-throw, spring-return switch which is normally in the position shown in the diagram. It connects the substation to the selector switch of the master station. When this switch is depressed, the substation is connected to terminal A1 which, in turn, goes through S1-C directly to the input transformer T1. It therefore bypasses the selector switch and permits any substation to call the master, regardless of the setting of the selector switch, so long as the press-to-talk switch of the master is in the "listen" position. The cable can be up to 1000 ft. long. The pilot light is No. 40. If noise is excessive, change value of C9 to .25 mfd.

No. 18 bare wire serves for B-negative bus (or common) floating ground side of the circuit. The only direct chassis-ground connections are made at points indicated by the chassis-ground symbol. The L bracket for the selector switch is 2 in. high and 1 1/8 in. wide. A standard sheet-metal chassis base 2 x 5 x 7 in. is used for the master station, see Fig. 1. The wood cabinet is a standard item, and it should completely house this a.c.-d.c. unit illustrated in photos A, B, D and E.

The small cabinets for the substations are a wall type covered with an attractive leatherette covering, see photo C for dimensions. Both these, and the master-station cabinet can be made with 1/4-in. plywood. When drilling the chassis base, the center of the hole for the press-to-talk switch is exactly 1 in. from the bottom of the chassis, as this switch is nearly 2 in. in diameter. Detailed student material list R-125 is available from Popular Mechanics Radio, TV and Electronics department upon receipt of letter postage. ★ ★ ★

Ford batteries are specially sealed in heavy, one-piece, impact-tested outer cases designed to give excellent protection against extreme temperatures. They are cycled from full charge to discharge hundreds of times to provide proper function and long life.



**Get the Battery
that's made right
for your FORD**

**All Genuine Ford Parts—like the battery shown above—are made right...
to fit the specifications set by the men who originally built your Ford!**

Why wait for battery failure to stall your car when a simple dealer test can determine the condition of your present battery? If replacement is advisable, he can recommend the Ford battery with the *right* capacity for your car's electrical system. Remember, every Ford battery has a liberal warranty. Be sure—have your battery checked today and...



"TRADE" WHERE YOU SEE THIS SIGN

pick up

BURGESS
flashlight
BATTERIES

BURGESS
CHROME PROTECTED FOR LONGER LIFE
GUARANTEED
BURGESS
CHROME PROTECTED FOR LONGER LIFE
GUARANTEED

Chrome Protected for longer life
ASK FOR THEM AT YOUR FAVORITE STORE
BURGESS BATTERY COMPANY • FREEDPORT, ILL. • NIAGARA FALLS, CANADA

A QUALITY DRY BATTERY FOR EVERY PURPOSE

Where to Find Fish in a Stream

(Continued from page 153)

shelter from the heat just as we do. Fish a bridge from the upstream side letting the lure ride the current into the deepest water under the bridge.

On most fast streams there are many bends where the water cuts under the banks. These spots are always deeper than surrounding water and may contain fish. If possible, fish them from the bank where they occur rather than from across stream. The lure is easier to control, you can stay concealed better and with a short line you are in better position to play the fish.

One of the most productive places is where a smaller stream empties into a larger one. Small streams carry a steady supply of food and there is usually an eddy formed at the junction. Cast the lure into the smaller stream, allowing it to float naturally into the larger one. You may see the swirl of a feeding fish almost as soon as the lure reaches the eddy.

Try the waterfalls in mountain country. Frequently they have pools or eddies behind them which are hard to reach but likely to contain fish. You may even have to poke the rod tip through the falls to get a lure into the water behind them but you don't have to worry about your approach. A fish lying in such water can see only a few inches because of air bubbles in the water.

In fishing a fast mountain stream your first consideration is to get the lure to float naturally into the most likely places. Usually you have trees, bushes or mountains behind you which prevent your figure from being silhouetted against the sky. Also fish cannot see too readily out of the fast moving water. This doesn't mean that you can go plunging carelessly along a mountain stream and hope to catch fish. Every advantage should be taken of the cover.

Fishing a meandering stream in open meadowland involves an entirely different technique. In general you should look for the same signs, except for waterfalls, but your whole approach becomes vastly more important.

There is seldom any cover back of you to hide your silhouette. The smooth surface allows the fish to see more clearly and, instinctively knowing that they in turn can be seen more clearly, they dart for cover at the slightest movement. Always approach a meadow stream cautiously from one side. Study the spot you want to fish from a distance to determine the flow, whether there are undercuts along the

(Continued to page 240)

Wider Speed Range Means Extra Tool Use

Now! Convert Your Band Saw
to a Metal Cutting Saw

CRAFTSMAN SLO-SPEED CONVERTER



Mount Slo-Speed Converter on motor shaft. Can be used with any 10-inch to 14-inch band saw with $\frac{1}{2}$ or $\frac{3}{8}$ -inch motor shaft.

CRAFTSMAN Slo-Speed Converter only
(Regular price \$25.00)

\$21⁹⁵ Cash
\$2.50 Down



Change Drill Press Speeds in
Seconds for Routing . . . Shaping!

CRAFTSMAN VARI-SLO SPEED CONTROL



Speed Control mounts right on drill press column. Variable speed pulleys mounted on four grease-sealed precision ball bearings.

CRAFTSMAN Vari-Slo Speed Control only
(Regularly \$22.95)

\$19⁹⁵ Cash
\$2.00 Down



Slows blade speed in seconds!

Price cut \$3.05. This amazing band saw attachment converts from hi-speed to slo-speed in just a few seconds . . . gives slower speeds necessary for cutting brass, aluminum, and other non-ferrous metals. Can be used with CRAFTSMAN 99-242B Band Saw, or ANY 10 to 14-inch band saw with 1750 R.P.M. $\frac{1}{2}$ or $\frac{1}{2}$ -H.P. motor and $\frac{1}{2}$ or $\frac{3}{8}$ -inch motor shaft. Gives 10 to 1 reduction ratio.

Converter mounts easily on motor shaft by locking one set screw and attaching two torque arms (furnished). Precision machined; has positive-drive cog belts. 6 self-lubricated ball bearings; one self-lubricated needle bearing. Built-in safety device helps prevent overloading of band saw blade and cog belts. Instructions included.

We recommend using CRAFTSMAN Band Saw Blades, 9-2625 for cutting steel (price \$1.98 each) and 9-2624 for cutting brass and non-ferrous metals (price 98c each). Blades are of finest quality saw steel. See the CRAFTSMAN Slo-Speed Converter at your Sears Retail Store TODAY.

Change speeds with tool running!

Price cut \$3.00. Saves drills! Saves time! For use with CRAFTSMAN Drill Presses 99-2314 and 99-2313 only. It's the ONLY drill press attachment we know of that gives a 12 to 1 ratio with just one hand lever, without changing belts! You can drill $\frac{1}{2}$ -inch holes in steel, and increase R.P.M. to routing and shaping speeds in seconds! Enables you to select any speed from 300 to 3750 R.P.M. without stopping spindle. Just slide hand lever and lock it at desired speed as shown on speed indicator. Hand lever and speed indicator are conveniently located in front, at top of drill press head.

Easily and quickly installed on drill press column. No holes to drill or tap! Made of tough aluminum alloy and cast Tenzaloy. Variable speed pulleys mounted on four grease-sealed ball bearings; lubricated for life. All steel parts are plated to resist rust. Complete with 3 CRAFTSMAN V-belts, set screw wrench, and instructions. See it at your nearest Sears Retail Store TODAY.

CRAFTSMAN Hand and Power Tools by **SEARS, ROEBUCK and CO.**
Famous for fine quality . . . precision performance . . . low price!

TIPS for the HANDYMAN

ON USING L-O-F SUPER-FINE FIBER-GLASS

Here's a new insulating product of "1001 uses." Wonderfully easy to handle and apply. And so versatile, so effective, you'll find uses for it in a dozen places 'round the house.



Save fuel by wrapping fire-resistant Super-Fine around your heating ducts! Highly efficient heat insulation. Flexible, lightweight, easy to install.



Reduce dripping from cold water pipes. Reduce heat loss from hot water pipes. Spiral wrap them with Super-Fine. Will not mildew or rot.

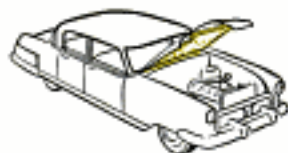

L-O-F Super-Fine installed under the hood of your car reduces airborne noise, tire whine and air-stream whistle.



Sound-insulate your home workshop! L-O-F Super-Fine provides excellent sound absorption. Cuts easily with scissors or knife.



Get L-O-F Super-Fine at your favorite hardware dealer's, where this rack is on display. If your dealer doesn't have it, write Libbey-Owens-Ford, Fiber-Glass Division, 4834 Wayne Building, Toledo 3, Ohio.



FIBER-GLASS

banks and the point where you should make the cast. Now approach from one side, making sure your figure does not loom up suddenly. If necessary traverse the last few feet on your knees. If there are shrubs, weeds or high grass along the stream's edge, stay behind them and make a blind cast. Raise up just enough to enable you to watch through the leaves as your lure floats into the desired spot. If there is no strike lift the lure gently from the water for the next cast. Never jerk a lure from quiet waters.

Along these open streams look for deep pools and undercuts in grassy banks. Ride the lure into them without fuss from above. Work from one side, well back, never showing yourself at the stream's edge with clear sky behind you. It is usually best to approach the water with the sun at your back, providing your shadow does not fall directly upon the water. Fish, like people, have difficulty looking into the sun. For the same reason try to cast the lure to float on the sun side of where you believe the fish to be. They are more likely to mistake an artificial lure for the real thing and less likely to detect the leader when looking in the direction of the sun.

My favorite method of taking skittish trout from an open stream is to approach from concealment, drop a fly tied on a fairly short leader of five or six feet over the top of some brush or high grass and, keeping the rod tip high, let the current bounce the fly on and off the water. In this method the rod is held steady, no line or leader touches the water and the fly bounces up and down in one place. It is a strong-willed trout that can resist that action. I've taken fish with this dapping method when everything else has failed.

Along most streams worth fishing, you will find a well-defined path made by anglers going from pool to pool. You will notice that the path usually bypasses the shallows or riffles where anglers, in their rush to get to the next pool, have passed up some good fishing. Feeding fish often come up out of the deep water to feed in the riffles. A lure floating down the current in a natural manner may be taken by a whopper. In these spots I like to use a wet fly tied on the lightest possible leader, though early in the season a natural bait is better.

The streamside path also goes by those stretches where heavy growth makes it difficult to reach the water. The majority of fishermen don't care to struggle through brush to reach water that may not be worth fishing when they get there. For that very

(Continued to page 242)

Mrs. America of 1954 says: **SAVE \$70.00 NOW ON MY SPECIAL**



American Kitchen

Only \$9⁵⁹ a month... No money down!



Mrs. America of 1954 in "Mrs. America" house in Ellnor Village, Florida

... save even more ... install this 8-ft. kitchen yourself in a few hours!

This month only ... the complete "Mrs. America" kitchen is just \$299.95! Eight feet of American Kitchens' famous quality and work-saving, time-saving convenience ... 54" sink, two 21" base cabinets, two 21" wall cabinets, and two what-not shelves. Installation is so easy ... so fast! Instructions packed with cabinets. Quantities limited ... see your dealer today about this big bargain offer!

"Cabinets of steel for lasting appeal"



American Kitchens, Dept. PM3
AVCO Mfg. Corp., Connersville, Ind.

Here's 25¢. Rush new, full color, 24 page booklet, "New Kitchen Designs for Living" ... layout, decorating, equipment.

Name _____
Address _____
City _____ Zone _____ State _____

AMERICAN KITCHENS DIVISION  CONNERSVILLE, IND.

Refinishing Furniture ?



Here's a kit-full of
**GOOD
SHORT-CUTS**
from "Handy" SANDY

Best news of the year for all you home-craftsmen is CARBORUNDUM's just-out "Furniture Refinishing Kit" — man, it's a dandy! A big 16-page instruction book takes you step by step . . . removing the old finish — staining, filling, sealing — sanding and rubbing final finish coats. There are 22 sheets of sandpaper, already cut to fit a sanding block — in 8 different grits and grades. Not just "sandpapers", but the top-quality papers the professionals use . . . garnet, silicon carbide waterproof, aluminum oxide moulding cloth.



GET THIS
BIG-VALUE KIT AT
YOUR HARDWARE
STORE—OR DIRECT
FROM US, WITH
COUPON BELOW

It's worth over a dollar of anybody's money, but your hardware store or building material dealer sells it at about 90c. All stores **should** have it in stock, but of course there'll be some who won't. If your store is out, send me his name and address, and a dollar bill, and I'll send your Kit direct to you, postage paid. Use the handy coupon below — and please give me your dealer's name and address, so he'll have stock next time you go back. And you will go back, I'm sure — that's how good these sandpapers and easy instructions are!



CLIP AND MAIL THIS TO ME

"Handy" SANDY
CARBORUNDUM®
Niagara Falls, New York

I usually buy my hardware and building materials at

Name of Store.....

Street..... City..... State.....

Enclosed is \$1.00. Send me your "Furniture Refinishing Kit"

My Name.....

Street & Number.....

City..... Zone..... State.....

90-227

reason, however, it may be the best spot on the river. In these protected stretches the fish will take lure properly offered. A short rod is easiest to handle here and a short leader is a must too, since there is seldom casting room. Usually you will have to poke the rod through the bushes and let the lure drop on the water, paying out line by hand as it moves with the current.

One of my favorite fishing spots is located less than 20 yards from a well-beaten path. The growth is so thick I have to crawl part of the way in, pushing my rod ahead of me. Each time I come out I first make sure no one is about, and I always conceal the spot. No one has yet intruded there and I feel sure I will have a "private" fishing hole as long as anglers follow the line of least resistance on that stream.

Some of our finest stream fishing is to be found in those streams so small they are passed up by anglers looking for bigger waters. Two of the best trout streams I have ever fished, one in Utah and one in New Mexico, are so narrow I can step across them at almost any point, yet I've taken limits on both streams in less than a half mile of fishing. You seldom take lunkers out of these little streams but they hold some mighty fine "eatin' size" trout.

Study the quieter patches of water to determine the kind of insect present near the surface, then select a fly that closely resembles the natural one. If possible use the real thing. In meadow streams, grasshoppers are good in late spring and summer. If you have any doubts about what the fish are taking, cut open the first one you catch and see what its stomach contains.

Whatever you use, if you study the water before you fish it, you will take home a heavier creel.

Next month: "Where to Find Fish in a Lake"

Aircraft Fuel-Weight Indicator

Weighing less than eight pounds, a new electronic instrument answers a pilot's problem by measuring airplane-fuel consumption in pounds instead of gallons. Jet engine fuels vary widely in density under different, fast-changing conditions and exact information on the weight of fuel entering engines has not been available to pilots or flight engineers. The Gavco Mass Flowmeter will extend the range of both jet and piston-engine aircraft by reducing the need for wide fuel margins for safety in flight planning. It fits into the fuel line and permits reading of the fuel-consumption rate in pounds-per-hour directly from an indicator, without the need for making additional calculations or corrections during a flight's progress.

Look what you can do with this New Black & Decker Saw!



\$64.50
B&D Utility 6"
Heavy-Duty Adjustable Saw
COMPLETE WITH BLADE

Try it yourself and get a chance to win \$1,000.00

Get a demonstration of this wonderful new saw at your Utility dealer. Then fill out a free entry blank, describing the features you like best—and you may win \$1000 in Black & Decker's big Saw Contest!



Bob Davis says:

Send 25c for my "Handy Tips" booklet, full of home repair ideas plus information on patterns for projects like sample below. * (No stamps, please).

*T. M. Rea, East-Std Pattern Company



For address of your nearest dealer see "TOOLS - ELECTRIC" in the Yellow Pages of your telephone book.

Need more living space? Do-it-yourself materials let you convert your attic or basement at far less cost than you ever dreamed! And the new Black & Decker Utility 6" Adjustable Saw takes the back-breaking work out of the job!

This new saw makes angle cuts, bevel cuts—every cut you need to add a beautiful room to your home, or make bookcases, cabinets, etc. You can get information on plans and patterns by mailing the coupon below, and your dealer will advise you on materials. When you visit him, ask to try the new Adjustable 6" Saw—as well as the larger 7-, 8- and 9-inch Heavy-Duty Utility Saws!



Fully adjustable for every depth and angle cut from 2" at 90° to 1 3/8" at 45°.



Powerful B&D-built motors take the tough spots without overheating or slowing.



New lever arm permits safe retraction of lower guard to make pocket cuts.



B&D saw-grip handle is always at natural sawing angle. Rugged, king-size shoe gives better balance.

Black & Decker

UTILITY [®] PORTABLE ELECTRIC TOOLS

Bob Davis, Home Service Dept. H3M, The Black & Decker Mfg. Co., Towson 4, Md.
Please send me "Handy Tips for Handy Men." I am enclosing 25c.

Name _____
Address _____
City _____ Zone _____ State _____

Speedway teaches

BETTER SHOCKS

give smoother, safer ride!



BILL VUKOVICH, after winning the Indianapolis "500", said, "Again Monro-Matic Shocks (on my car) proved their ability to provide a safe, stable ride under the most adverse conditions." His opinion is supported by the astounding fact that in the 1953 Indianapolis "500," the four fastest cars were all Monro-Matic equipped.

SOFT, WHIPPY

SPRINGS of modern cars must be controlled by shock absorbers to prevent dangerous bouncing and to keep wheels on the road for best traction and safety. Worn shocks should be replaced promptly for greater safety and comfort.



IMPROVED TRACTION is obtained through the action of the new Monro-Matic Shock Absorbers, the only shock absorbers with automatic adjustment. Drivers report in qualifying tests at Indianapolis, "After installing Monro-Matic Shocks, increased miles per hour 10%."



SEND 10 CENTS for new Shock Absorber Manual. Tells the right shock for every car, gives instructions for removal and installation.

MONROE AUTO EQUIPMENT COMPANY
MONROE, MICHIGAN

Back-Loaded Cabinet for Super-Fidelity Home Phono

(Continued from page 160)

centered on the hand hole provided in item 7, the record shelf, Fig. 9. From the top, through the phono-motor floor, two more screws are inserted to hold the panel firmly. The dowel rod merely acts as a guide for centering the panel. Photo H shows rubber mounts for player.

The cabinet lid is fairly heavy, and you may wish to add a feature to make it easier to raise. This is a "light slam" device available from hardware stores, which includes two helical springs, two angle aluminum pieces and two short lengths of chain. It is easy to install and keeps the lid from going back too far. Note the cut-out in the rear of the record shelf Fig. 9, which is item 7. This does two things: it will support either 10 or 12-in. records, yet allows free passage of sound for the back-loading of the speaker (remove records). The hand hole cut in the front of the record shelf aids in removing records, and also permits easy access for screwdriver when inserting the panel holding screws in item 3, the speaker floor. Figs. 10 and 11 are speaker

(Continued to page 246)

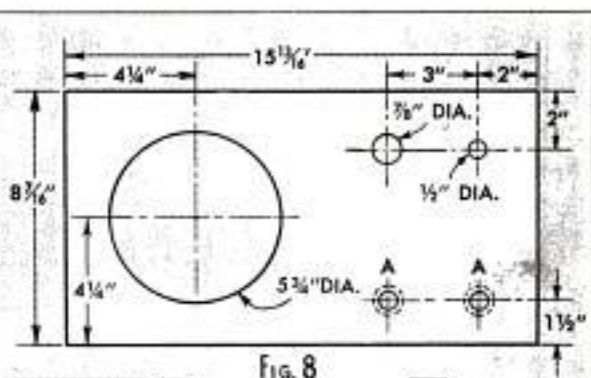

FIG. 8

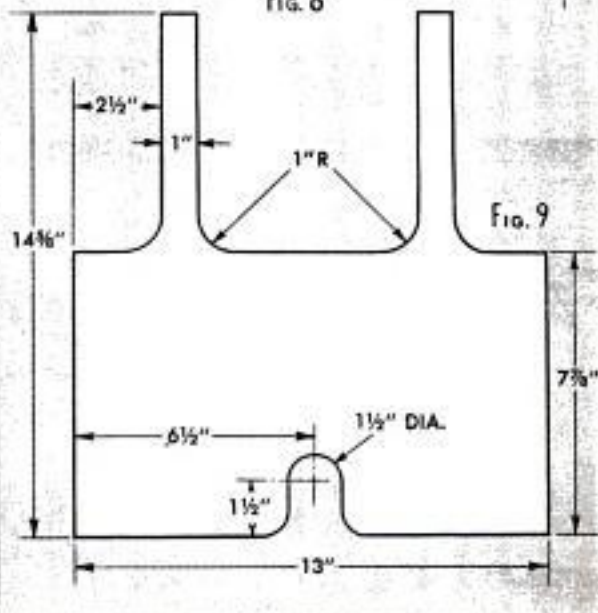

FIG. 9

"Your best buy in power saws is MAXAW 700 with magic•pivot"

says Paul Jones, President, Cummins-Chicago Corp.

The Cummins MAXAW 700 I'm using makes that all-important 45° cut in 2 x 4's—with blade to spare. It makes every cut for every house. In fact, on a dollar-for-dollar and pound-for-pound comparison, the MAXAW 700 outperforms every saw in the 7" field. Yet it's so perfectly engineered that it weighs only 10 pounds—much lighter than other saws in the 7" field.

There in a nutshell is the amazing story of MAXAW 700 with *magic•pivot*.

The man who brought about the engineering miracle of MAXAW with *magic•pivot* is Fred Wappat, often referred to as the "power saw Edison." Mr. Wappat pioneered the portable power saw and was responsible for many of its early developments, one of the most notable being the telescopic guard.

But his greatest achievement—and the greatest made by any one individual in the power saw field—is the *magic•pivot* in Cummins MAXAW. Now, here is precisely what *magic•pivot* does:

Blades last twice as long

magic•pivot gives the saw blade of your MAXAW greater cutting depth at 45°, you get blade to spare. MAXAW blades will take three to four more sharpenings than blades of similar diameter used on other industrial saws. This means *magic•pivot* lets you use blades twice as long.

"Stub-radius" blades reduce friction, shock
magic•pivot permits MAXAW to use "stub-radius" blades to do the same cutting jobs as heavier saws with larger blades. With "stub-radius" blades there is less leverage re-acting on the saw mandrel shaft. Therefore, there is less shock transmitted to the gears, ball bearings and armature of the saw.

Puts more power at cutting edge

Power always diminishes as it reaches out from the saw shaft to the blade cutting edge. With *magic•pivot* which enables you to use "stub-radius" blades, distance from the power shaft to the cutting edge is shorter than with larger blades. Result—you get more power where you need it—at the cutting edge.



Less bulk—less weight handicap for user

magic•pivot reduces the handicap you place on a man on the job. A 1200-lb. race horse is handicapped with an average of 1 to 10 lbs. of lead. He works only a few minutes in each race. A man weighs from 150 to 200 lbs. He climbs ladders, roofs . . . is on the move 8 hours a day. He's handicapped on the job with anything but the lightest weight saw—the MAXAW 700 weighing only 10 pounds.

Mister, if you want a power saw that saves you time, money and energy, you want the MAXAW 700 with *magic•pivot*. It's perfectly balanced to stay on the cutting line, guides itself without pulling or wavering. This is the portable saw priced for the home handyman as well as the professional user. Imagine being able to get all this performance in an all ball and roller bearing 10-pound power saw—for only \$69.50. That's right—only \$69.50 buys you the finest power saw in the 7" field—the MAXAW 700. Ask for Cummins MAXAW 700 at your hardware or lumber dealer's. Don't settle for anything less. I'll be glad to send you our fully documented folder: "What *magic•pivot* Means To You." Every man who is interested in portable electric saws should read it. Please write me today.

Sincerely, *Paul Jones*
PRESIDENT

COPYRIGHT 1954 CUMMINS-CHICAGO CORP.

CUMMINS-CHICAGO CORP., 4740 N. Ravenswood Ave., Chicago 40, Ill. In Canada: 334 Lauder Ave., Toronto 10
Makers of MAXAWS, MAXDRILS, BALL•RITE and PERM-ALIGN DRILLS, FIXMASTER KITS, do-it SHOP

Save money DO IT YOURSELF with SPEEDY RIVETS



BIND REPORTS



REPAIR LUGGAGE



FIX FOOTWEAR



MEND CLOTHES

Do jobs you never thought you could do yourself . . . fasten cloth, paper, plastic sheeting . . . ideal for craftwork, too . . . quick, secure, permanent. Simply punch a hole in each part to be fastened, push rivet together through holes, place on firm surface and swat with a hammer. Gilt, nickel, black, brown finishes: Large (6 to a card) or small (10 to a card) sizes.



AT HARDWARE COUNTERS
EVERYWHERE 15¢ per card

THE **DOT** LINE

CHICAGO 8, ILLINOIS

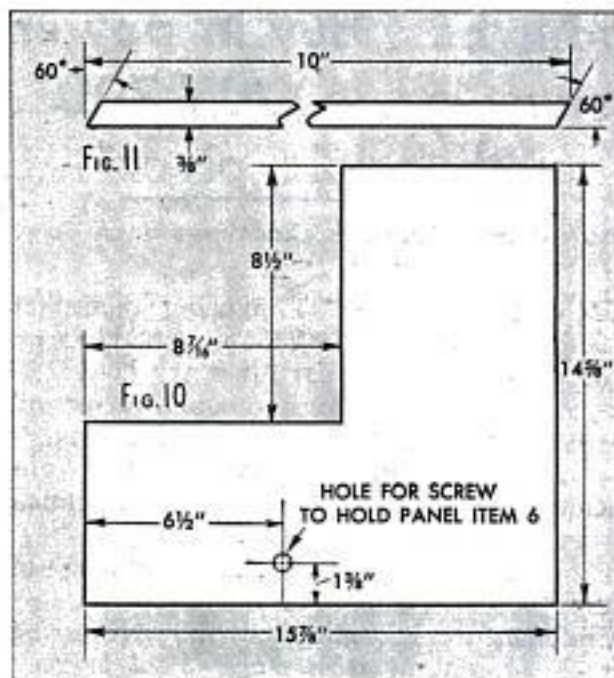

floor and baffle details, items 3 and 10.

When finishing the cabinet, use No. 00 sandpaper in the direction of the grain. Follow this with an oil stain. This dries in a few minutes, but should be left overnight to set. Finish with a clear varnish.

A few final tips on the operation of the amplifier may be useful. If it should "putt putt" (motorboat), the 15,000-ohm feedback resistor value is too low and should be replaced with a higher value, such as 20,000 or 25,000 ohms. Match resistors R19 and R20 should be alike for balanced operation. Detailed student material list R-424 covering the complete amplifier and cabinet construction article is available from Popular Mechanics Radio-TV and Electronics department upon receipt of ordinary letter postage. ★ ★ ★



POPULAR MECHANICS

Truck Limpy?



Payload Skimpy?



Cab Crimpy?



Solve it Simply?

See the '54 **REO Today!**

Reo's *Gold Comet* power whisks Reos over hills up to 15% faster than similar trucks carrying the same payload. Speaking of payload . . . Reo's exclusive more-payload design permits heavier loads and bigger ton-mile earnings. The new luxurious cab provides every convenience . . . increased head and leg room . . . full 30" door opening . . . new steering wheel angle gives unobstructed driver vision . . . electric windshield wipers . . . foam rubber seat available on all models. This is only a part of the story, get the proof yourself . . . test drive a REO and learn to relax!



REO MOTORS, INC.

LANSING 20, MICHIGAN

Manufacturer of Commercial & Military Trucks • Buses • Power Lawn Mowers • Children's Wheel Goods & Playground Equipment • Inboard Engine Kits for Small Boats • Replacement Engines for Trucks • Industrial Engines

MARCH 1954

Copyrighted material 247



So easy to have the windows you want with the **NEW CURTIS** **CONVERTIBLE**

Here's the most amazing window you've ever seen! The new Curtis Convertible wood window can be used as an awning—casement—hopper-type sash—in more than a thousand different combinations! And the Curtis Convertible is so easy to install! It's completely factory assembled with basic frame, operating hardware, sash, screen and insulating light. Low in cost, the Curtis Convertible is fully guaranteed as to materials and workmanship.



Here the Curtis Convertible is used as a casement.

Ideal for use as awning style window.

Ventilation at floor level with hopper-type window.

Sold through retail lumber dealers everywhere.



Curtis Companies Service Bureau
200 Curtis Building
Clinton, Iowa

Please send literature on Curtis Convertible windows and other Silentite window styles.

Name.....

Address.....

City.....Zone.....State.....

The Shape of Tomorrow's Planes

(Continued from page 138)

are three problems that have to be studied together.

The most practical engine for high speed at present seems to be a jet engine equipped with afterburner. This combination makes best use of the jet at low speeds and takes advantage of the afterburner at high speeds. The combination is lighter and has less frontal area than a jet engine designed to produce the same amount of power. The ramjet, excellent at supersonic speeds inside the atmosphere, is inefficient at subsonic speeds. Rocket engines are best of all in theory but they are ruled out except for short bursts of speed because they consume from six to eight times as much fuel as does an afterburning jet.

One problem that is occurring already is the aerodynamic heating of the engine intake air at high speeds. At 750 miles per hour at low altitude this can amount to 100 degrees. When added to the heat of combustion, the temperature inside the engine may approach the thermal limit at which the engine is designed to operate. Turbine blades may melt or fly apart. Blades that are made of special high-temperature metals or of ceramic materials may be a solution, if such blades can be built.

The vulnerability of engines, electrical systems and the pilot to heat suggests that our present airplanes couldn't travel faster than 700 miles per hour at sea level or 1200 miles per hour at 35,000 feet even if they had the power to do so. The 700-miles-per-hour aircraft would be subjected to a temperature rise of 100 degrees, while the plane traveling at 1200 miles per hour would have a heat rise of 275 degrees.

It's true that several planes have gone faster than these speed limits but only for a relatively few seconds at a time. The Skyrocket, for instance, didn't travel at 1327 miles per hour long enough to overheat. If it had continued to cruise at that speed the whole plane would have attained the temperature of boiling water. The X2 research plane, successor to the 1600-miles-per-hour X1A, has a skin of stainless steel to resist the softening effect of heat.

Aerodynamic heating from friction with the air is a problem at today's fast cruising speeds. Complex and relatively heavy refrigeration equipment has to be installed in fighter aircraft to keep the electronic systems and the human pilot at safe operating temperatures. In addition to the aerodynamic heat there is the heat from the electronic systems that must be dissipated. Already the problem is approaching the

(Continued to page 250)

What a Difference

Between the Oldest and the Newest

BUICK

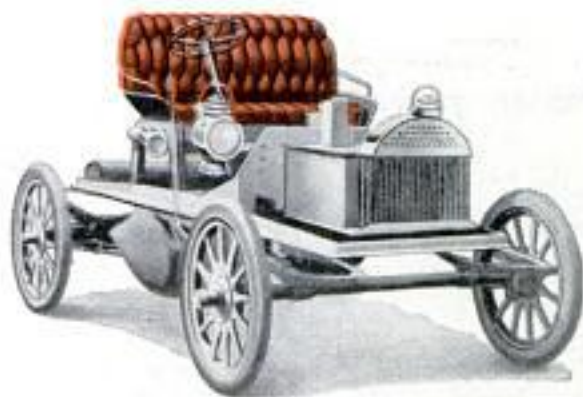

This 1903 "buckboard" model was the earliest of all Buicks. It had a two-speed transmission and a dependable two-cylinder engine which developed 21 horsepower.



The spectacular "Skylark" has a 200-horsepower engine. On a chassis with 122-inch wheelbase, the car is less than five feet high, even when the top is up.

And What a Difference in Plug Performance Since AC Developed the Patented CORALOX Insulator



Original Equipment
on Nearly as Many New Cars
as All Other Makes Combined

The 1903 Buick was as much a sensation in its day as the sleek new "Skylark" is today. But what a difference that half century has made in Buick appearance and performance! AC Spark Plugs have a similarly brilliant record of improvements down through the years—the latest and greatest of which is the patented CORALOX Insulator.

CORALOX has no chemical attraction for the oxide coatings resulting from the burning of leaded fuels. What's more—CORALOX is so amazingly strong that AC can use longer, thinner insulator tips which heat up faster to burn away oil and wet carbon deposits. As a result many motorists—

- GET UP TO 10% MORE POWER
- SAVE UP TO ONE GALLON OF GASOLINE IN TEN

AC SPARK PLUG DIVISION



GENERAL MOTORS CORPORATION

Gardeners you know:



Clara Froo-Froo

Miss Froo-Froo turns up her nose at all but the most costly specimens of flora. Pays up to \$75 for a single bulb. Has custom-made plant food flown in from Venezuela every week. Looks down her lorgnette at Vigoro* because she can't believe it could possibly be specialized enough for her posies and lawns.

Miss Froo-Froo is not as unusual a gardener as you might think. Many people believe that a plant food must carry a big price tag and a fancy label to be effective.

They fail to realize, as you might, that Vigoro is not only complete, but scientifically balanced to give amateur and expert alike the best results. Proof of this is the fact that gorgeous flowers have been grown in sterile sand with no other nourishment but Vigoro.

The truth is, you might pay more for some plant foods or use less of others, but you actually can't feed better than Vigoro, the most widely used plant food in the world.

Use regular Vigoro or the new Instant Vigoro that's soluble in water.

*Vigoro is the trade-mark for Swift & Company's complete, balanced plant food.



point where it may be necessary to insulate the pilot from the cockpit by designing a ventilated flying suit through which a stream of cool air is pumped. In making their runs for the world record last fall the British played extra safe and placed slabs of Dry Ice in the cockpits to help keep their pilots cool.

The nose and adjacent windshield area of a plane heat up first and attain the highest temperatures. This is especially unfortunate because plastic windshield materials are among the first substances that fail when the heat goes up. Double-walled windshields with cool air circulating between the walls may have to be adopted soon.

No real cure for aerodynamic heating is in sight, and the problem is being attacked in two ways. One is to build fast aircraft of materials that won't be affected by heat to the point of failure, the other concerns the possibility of preventing the aircraft from heating up even though it does fly fast.

It would be nice to put insulation on the outside of a plane, or to envelop the plane in a film of cold air, if either was possible. Reducing the friction that causes heat seems more practical and, working toward that idea, the NACA is investigating what is called laminar flow. It's the air of the boundary layer clinging to a plane's surfaces that heats up first, the theory goes, and this air in turn transmits heat to the structure. If the surfaces of the plane can be made as smooth as glass and if the entire aircraft is aerodynamically smooth, there will be less friction and the boundary layer won't heat up as much. That's the idea, though manufacturers groan when they consider the problems of building a really slick aircraft.

One thing the engineers are confident about: In the long run the thermal barrier will be overcome just as a solution was found to the sonic barrier that only a few years ago was thought to be a final speed for inhabited aircraft. The sonic hurdle became nonexistent when new planes, airfoils and engines were developed to overcome it. Similar research aimed at overcoming the thermal barrier will achieve similar results. ★ ★ ★

Ideas Popping Up at Faster Rate

Inventors in this country are developing new ideas at an increased rate. At the beginning of 1954 there were a total of 105,303 patent applications on file at the Patent Office. This compares with 97,747 at the start of 1953. The Patent Office, since it issued its first patent in 1790, has granted more than 2,665,000 patents.

Ask your hands to tell you

You don't have to be a carpenter to want, yes, even to need — fine tools. Put a Stanley tool in your hands. Use it. You'll feel the difference. For everyone from schoolboy to professional

Stanley is the toolbox of the world.

Tool UP With Stanley Take this "100 PLUS", for example. Sure, you can drive a nail with almost any hammer — one way or another. But your hands will tell you *this* one. It hits the nail hard, and drives it straight and deep. You'll get a smacking sense of satisfaction every time you use it.

*Western prices slightly higher.

"100 PLUS"
No. 111½ — \$3.50*

Measure UP With Stanley



No. X226 —
6 ft. — \$2.75

A good rule is a must, and a new favorite is this Stanley '100 PLUS'. It's a good friend, many times tested and all ways true. The joints lock firmly, the square ends stay square, the handy 8-inch brass slide slides but never slips, the easy-to-read numbers are always easy to read. For *more* than a measure of satisfaction, say Stanley the next time you buy a rule.

Tool UP With "YANKEE"



No. 41 — \$5.65

The "Yankee" push drill is a quick, one-hand worker . . . the ideal tool for boring screw holes. The drill point spirals in easily and the built-in spring returns the handle for the next stroke. You're through in no time. What's more, the magazine handle holds 8 drill points from 1/16 to 13/64 inch — the size is always right.



THE TOOL BOX OF THE WORLD

STANLEY Tools

How Long Is Your Square Tongue?

Sure that's a silly question. But if you haven't a steel square you'll never know.* On the other hand, with one of these Stanley rafter squares you can really get on top of things — build a roof, for instance, on your new porch or garage. Send for your free copy of "Rafter and Framing Squares". You'll learn all about roof framing, common rafters, hip and valley-rafters, brace measures, etc. Use the coupon.

*The Stanley rafter square tongue is 16" long.

ELECTRIC TOOLS • HARDWARE • STEEL STRAPPING • STEEL

STANLEY TOOLS, 344 Elm Street, New Britain, Conn. or
STANLEY TOOL CO. of CANADA, 344 Stanley St., Roxton Pond, Que.

- Please send me STANLEY TOOL GUIDE for which I enclose 25¢.
 Please send me FREE "Rafter and Framing Squares" — \$51.
 Please send me FREE "YANKEE" Tool Book Y41.

Name _____

Address _____

City _____ Zone _____ State _____

HOW TO FINISH OFF YOUR ATTIC



This free book makes it easy...

You can turn wasted attic space into extra rooms in a jiffy! These 8 pages of step-by-step, easy-to-follow instructions tell you how to floor, frame, trim and paint. And how to insure comfort with efficient, fire-safe, sanitary Fiberglas* Insulation! Write for your copy and get started—now!



OWENS-CORNING
FIBERGLAS

Owens-Corning Fiberglas Corporation
Nicholas Building
Toledo 1, Ohio

Please rush a copy of the "How to finish off your attic" book to:

NAME _____

ST. ADDRESS _____

CITY _____ ZONE _____ STATE _____

ST. M. Reg. U.S. Pat. Off.

Here's the Long-Life Battery

(Continued from page 99)

A plate measuring about $2\frac{3}{4}$ by $2\frac{1}{2}$ inches contains not less than 125 square feet of chargeable surface area. The result is a lot of power from a little package. And it will deliver that power at a steady level if you pull at it fast or slowly.

A tiny transparent plastic cell the size of a cigarette lighter puts out enough juice to light up 100 flashlight bulbs at once. A five-celled unit, measuring about 4 by 6 by 2 inches, packs about 300 amperes, enough to start a car engine. Of course there wouldn't be much left for lights, wipers or radio after the start.

Engineers at Sonotone are still testing their battery under every conceivable condition. One unit has been drained and recharged 3000 times under varying temperatures and conditions. Stored away, fully discharged for several years, they zoom right back up on recharging, good as new. They have been left standing for days in weather down to minus 40 degrees, and they started the car engines at the touch of the starter button. There's a big battery in Canada now for tests down to minus 65 degrees. The freezing point of the potassium-hydroxide electrolyte is minus 75 degrees.

Sonotone's battery had its beginning after World War II, when Hector was tossed the job of developing a rechargeable battery for hearing aids. It wasn't until 1948 after an intensive hunt that his research team came on the work the Germans had done and decided to iron out production bugs the Nazis never solved. By the time they had the thing licked, hearing-aid dry cells were down to lipstick size; transistors promised to reduce them to the size of aspirin tablets and give them great additional life. Nobody needed a hearing-aid battery that could be recharged.

But the battery had other uses. The Signal Corps looked and suddenly decided it needed some larger ones. In the past four years Sonotone made 600,000 of them for military equipment. In 1953, Navy contracts totaling \$1,000,000 went to the SAFT company in France for similar sintered-plate nickel-cadmium batteries. This year, with removal of controls on precious nickel, both companies plan to storm civilian markets. The American Bosh Company of Springfield, Mass., and Canadian Aviation Electronics in Montreal, also will produce them under license from Sonotone.

"We hope to have ours for sale in places like accessory shops and some service stations in 1954," says Dr. Hector. "They

(Continued to page 254)



Clean, easy-to-apply PENTA adds years of useful life to the things you build with wood

THE DOW CHEMICAL COMPANY
Dept. PE-765N
Midland, Michigan



- Please send FREE BOOKLET—"Handyman's Guide to Home Wood Preservation."
 Send the name of my nearest PENTA dealer.

Name _____

Address _____

City _____ Zone _____ State _____

Building your own lawn furniture saves money and it's fun, and you add to the profit *if* you protect the wood against termites and decay with PENTA*. PENTA is easy to apply—simply flood it on with a broad brush or dip each piece before assembling. This leaves the wood clean, pleasant to handle.

Water-repellent solutions containing PENTA also improve dimensional stability and reduce checking caused by moisture and hot sun. Wood treated with these solutions is paintable. "Handyman's Guide to Home Wood Preservation", a booklet by Dow, tells you how to use PENTA solutions on all the projects you plan for house and garden. *Send for your free copy.* Your local lumber dealer or hardware store has name-brand wood preservatives containing *PENTACHLOROPHENOL in regular and water-repellent types. Look for the name PENTA on the can. THE DOW CHEMICAL COMPANY, Midland, Michigan.

you can depend on DOW CHEMICALS

DOW

**WHAT
DO YOU WANT?**

**A GOOD BUSINESS
OF YOUR OWN?**

**A HIGH PAY
SPARE-TIME
JOB?**

Then **FOLLOW THIS
PROVED SUCCESS PLAN!**

Here is your chance to be your own boss, secure financial independence, build a future for yourself and your family in a profitable business in your own garage or basement. J. S. of Michigan writes, "I figure my profits (last season) at over \$1,000.00." Mr. C. H. R. of Ohio says, "This season I have taken in \$3,688.20." J. P. of Pennsylvania writes "I spent only 40c for a newspaper ad and have done nearly \$500.00 worth of business." Another owner writes, "I have had 4 mowers a day brought to me since last May . . . and do the grinding evenings at an average of \$2.50 each." Think of it! That's \$10.00 an evening in spare time. If you want to get ahead, make big money, be your own boss. Act Now. Write today for full details of our proved success plan.

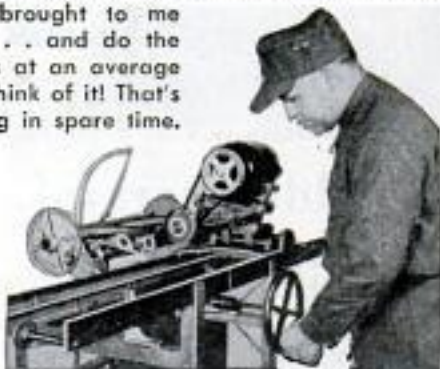

ONLY ON THE UNIVERSAL LAWN MOWER GRINDER

can the inside face and edge of the stationary blade, and all reel blades, be ground to proper clearance

ALL IN ONE SET-UP

WITHOUT REMOVING ANY BLADE FROM THE MOWER

. . . that's why this business is simple, easy, and interesting. No experience or long hours of study are necessary. A leading National Magazine says, even an inexperienced worker can do a good job. We furnish complete instructions, everything you need to get started . . . But you must take the first step. Just fill in and mail the coupon below. Do it right now.

ROGERS MFG. CO., DEPT. M-34, LINDSEY, OHIO

SEND THIS COUPON NOW

ROGERS MFG. CO., Dept. M-34, Lindsey, Ohio

Please send me full details about the profit possibilities of Lawn Mower Sharpening.

NAME _____

ADDRESS _____

CITY _____ STATE _____

should be supplied as original or optional equipment in some cars during the second quarter of this year."

"Percentage-wise," says Dr. Hector, "our biggest market won't be automobiles, though we expect to sell a lot of them in the cold parts of the country where car-starting is tough in winter. Taxicabs, whose engines seldom stop, wear out heavy-duty batteries at the rate of one every four to six months, but they'll have a tough time beating up one of these inside 10 or 20 years. We think they're naturals for trucks, buses and other hard users."

Most of them, however, Sonotone expects will go to industry—in ships, boats, planes, diesel engines, miner's lamps, power stations, isolated unmanned relay stations for radar or TV and standby equipment like emergency telephone generators—where the batteries would kick over after years of standing idle and being virtually ignored. Railroad block signals may see them as a power source. ★ ★ ★

Radar Spots Cancer

With a new radar tool, doctors may soon bring about early detection of interior cancer. The device emits radar beams as it is used to scan the patient. A near-by screen registers impulses rebounding from tissue, with cancerous tissue producing a denser impulse. Dr. John Wild demonstrated the device at a Minnesota Medical Association Convention.



BRAND NEW!
RUGGED!! MASSIVE!!

*** 25 TON CAPACITY HYDRAULIC CYLINDER**

- ALL STEEL CONSTRUCTION
- 8" BORE—15" STROKE
- DOUBLE ACTION



ITEM #1815
• 50,000 LBS. PRESSURE WITH 1000 P.S.I. PUMP OUTPUT.

- UP TO 70,000 LBS.—CAPACITY ON INTERMITTENT SERVICE.
- SOLID STEEL 2 1/2" PISTON ROD
- 1" PORTS
- OVERALL DIAMETER—10 1/2"
- DISTANCE BETWEEN CENTERS—28 1/4" CLOSED—43 1/4" OPEN.

IDEAL FOR:

- HYDRAULIC PRESSES • DUMP TRUCK HOISTS • TD-18, TD-24 INTERNATIONAL HARVESTER DOZERS AND GRADERS • LEVELING RAMPS • INDUSTRIAL MACHINERY • ROAD MACHINERY • FARM MACHINERY • HYDRAULIC TAIL GATES
- Replacement cost—\$100.00.
Shipping Wt.—185 lbs.
SPECIAL PRICE 95.00
F.O.B. Chicago.....

ITEM #1715

- 7 1/4" BORE—15 1/2" STROKE
 - 41,300 LBS. PRESSURE WITH 1000 P.S.I. PUMP OUTPUT.
- OTHER FEATURES SAME AS ABOVE
Replacement cost \$260.00.
Shipping Wt.—153 lbs.
SPECIAL PRICE 80.00
F.O.B. Chicago.....

BRAND NEW DOUBLE ACTION HYDRAULIC CYLINDERS



NEW MANUFACTURE

- ITEM #224—3 1/2" bore, 24" stroke, will lift 8250 lbs. with 1000 P.S.I. line pressure. 1 1/2" pipe thread ports—1 3/4" stress-proof ground, polished & plated solid steel shaft. Overall length closed 30".
Ship. Wt. 90 lbs. **39.60**
F.O.B. Chicago.....

- ITEM #16-C—1 1/2" bore, 26" stroke. Will lift 1760 lbs. with 1000 lbs. pump pressure. Great for hay loaders, etc.
1" stainless steel piston rod. Postpaid... **16.95**



- ITEM #355—2 1/2" bore — 7 1/2" stroke. Mfgd. by Delco-Remy. Clevis mounting.
3/4" pipe thread ports. **16.00**
F.O.B. Chicago.....

BRAND NEW! JUST RELEASED! BLACKHAWK HAND-HYDRAULIC PUMP

- ITEM #82. Perfect for Hydraulic Presses, Snow Plows, Farm Wrenches, Jacks, and Farm Plows. A few easy strokes of the 20" handle and you can lift 5000 lbs., using Item 355—Hydraulic Cylinder.
Blackhawk Model P-151—complete with built-in oil tank and release valve.

- Rated 1200-8400 lbs. per square inch. Dim. 9"x7"x6". Ship. wt. 35 lbs. Worth much more. F.O.B. **22.50**
Chicago.....

FREE SPRING — EDITION

1954 CATALOG, 52 PAGES, chock-full of unsurpassed War Surplus Equipment Bargains for farm, home, factory and workshop. Write today. Most advertised items just released, not yet in catalog.

BRAND NEW WAR SURPLUS. * RELEASED SINCE KOREAN TRUCE

NOW . . . SAVE \$161.00 on this \$250.00 VALUE
350 WATT A. C. PORTABLE ELECTRIC LIGHT PLANT

- Compact Electric Plant suited for small homes, cabins, campers, hunting and fishing camps, trailers and small electrical home appliances. Operating costs: About 5c per hour. Runs exceedingly quiet. Sturdily constructed for dependable service. Net weight only 88 lbs. Can be carried from place to place, or transported in trunk of car.

350 Watts—110 Volt—60 Cycle—A.C. Model—34-S, 35-3, made by Midea Mfg. Co. 1 Cylinder, 4 Cycle Engine complete with muffler, starting rope and oil bath air cleaner, direct coupled to a 350 Watt Generator with voltage control rheostat and twin outlets. Engine speed 1800 R.P.M. Shipping Wt. 116 lbs.
Commercial List Price \$250.00
NOW ONLY **89.00**

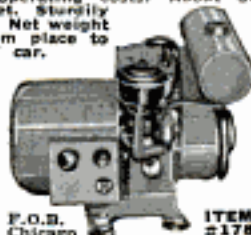

F.O.B. Chicago ITEM #178

FOUR-WAY, OPEN CENTER CONTROL VALVE

- ITEM #126 with built-in adjustable relief valve. Factory set at 1000 P.S.I., spring loaded neutral position, for use with one double acting cylinder. In neutral position cylinder is locked and pump unloaded. Fully balanced plunger type, smooth, positive, easy operation. Can be used as single unit or mounted in series of any combinations desired. Has 3/4" pipe thread inlet and outlet, 1/2" pipe thread cylinder ports. Newly manufactured to our specifications.

Shipping weight 8 1/2 lbs.
An outstanding buy! . . . F.O.B. Chicago. . . **21.50**

GOV'T. SURPLUS! JUST RELEASED!

*** 2-TON, 6-WHEEL HYDRAULIC LIFT TRAILERS**

- USE FOR: Conveyor ramp • Boat trailer • Lumber • Pipe • Pole trailer • Machinery trailer • Hydraulic dump for grain wagon • Coal truck • Lift truck • Variable height hydraulic work table • Removable rack permits use of hydraulic lift for other installations. Outstanding features of these trailers are—4000 lbs. payload, 2 individual hydraulic lifts complete with hand pumps and valves, 4 18"x5.5 pneumatic tires included. Manual screw-down brakes. Ball-bearing axles. V-shape load rack—8' long. Towing tongue, 54" lift. Wheelbase 98". Ground clearance 4 1/2". Tread width 52". Overall width—58". Overall length including drawbar—167". Gov't. cost \$685.00. Ship. wt. 1400 lbs. F.O.B. Chicago. **169.50**

HYDRAULIC SPEED REDUCER with FINGERTIP CONTROL

- USE FOR: Reamer Drives • Midget Cars • Feed Mills • Canning Machines • Conveyors • Lathes • Milling Machines • Motor Boats • Cream Separators • Garden Tractors • Pumps

- Variable output speeds from 0 to input speed available by moving control handle. Locking handle maintains setting. Use input power of 1/2 to 1 1/2 H.P. This Westinghouse-Oil Gear Unit consists of a variable displacement hydraulic pump feeding a fixed displacement hydraulic motor. Adjustable relief valves set at factory for 100 inch pounds of torque may be reset up to 180 inch pounds. Independent reverse control allows full output power and speed selection in either direction of rotation. Shafts measure 3/8" diam., include keyway. Input rotation is counter-clockwise facing shaft. Recommended input speed not to exceed 750 R.P.M. Overall dimensions, 7 1/2"x7 1/2"x11 1/2". Gov't. acquisition cost \$428.00. Ship. wt. 31 lbs. Complete with 2 qts. of oil **54.50** and full instructions. F.O.B. Chicago.

BRAND NEW — BERRY — HEAVY DUTY HYDRAULIC PUMP OR MOTOR

- NEW MANUFACTURE
ITEM #166—use on farm equipment, road machinery, vibrators, paper mills, wire reels, hydraulic brakes. Ball bearing construction, balanced cam design assures high efficiency performance. When used as a pump: delivers 11 G.P.M., 1000 P.S.I., 8 H.P. at 1800 R.P.M. as a HYDRAULIC MOTOR: Rated up to 12 H.P., up to 2400 R.P.M. Standard 3/4" pipe thread ports, 3/8" shaft with keyway. Dimensions 14 1/2"x8"x7". Weight 63 lbs. Regular price today \$912.00. Our money saving price **59.50**
F.O.B. Chicago, 2 for 110.00. Each

A.C. ELECTRIC GENERATOR

- ITEM #G-75 — 7500 Watts, 120 Volt, 60 Cycle, 1800 R.P.M. single and three phase current, for 2 or 3 wire circuits electric generator, double ball-bearing construction, standard 1 1/4" shaft with keyway, and included at no extra price. 5-groove six inch pulley for belt drive. Direct connected Self-Exciter Foot Mounted. Gov't. Acquisition Cost: \$345.00. Dim. 34"x11 1/2"x7". Ship. wt. 250 lbs. Price Blashed To . . . **269.00**
F.O.B. Chicago



PUROLATOR OIL FILTER

- ITEM #70—A perfect permanent element oil filter to keep your motor oil or hydraulic fluid clean at all times. Protect your pump or engine with this unit. Just turn the handle and the element is clean. Standard 3/8" inlet and outlet ports accommodate 16 gallons per minute. Shipping weight 4 lbs. \$1.90 value. **5.95**
NOW ONLY. Postpaid



SELF-PRIMING HAND FLUID PUMP WITH STRAINER

- TYPE B-2 — Bronze 2 1/2" diameter construction. 1/2 in. pipe thread ports. Fine general utility hand pump. May be used as a sump pump, barrel pump, fuel transfer pump, for water, oil, gasoline, insecticides, etc. Capacity—200 Gal. per hour. **11.95**
Ship. wt. 6 lbs. F.O.B. Chicago

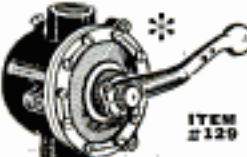

ROSS 4-WAY FOOT OPERATED AIR VALVE

- BRAND NEW — For double acting pneumatic devices. Fine for operating presses, air vises, and machinery of many types. Heavy duty cast construction. No neutral position. Maintains pressure against the piston when the foot control is in the "Up" position. Threaded for 1/2" pipe. Dimensions of valve body: 7 1/2" long x 4 1/2" width x 7 1/2" high. Net weight 28 lbs. A \$64.00 value for only. . . . **19.50** F.O.B. CHICAGO



D. C. GENERATORS

- TYPE ITEM #91
Rated 300 Amps.—110 Volts. Mfd. by Jack & Heintz. Gov't. Acq. Cost \$380.00. Ship. wt. 55 lbs. Dimensions 16" x 10" x 7". **35.00**
F.O.B. Chicago
ITEM #90 — Type P-1, rated 200 Amps.—28 Volts, 2500 RPM. Mfd. by General Electric, Ford, Delco-Remy and Westinghouse. Gov't. Acq. Cost \$300.00. Ship. wt. 55 lbs. Dimensions 15"x9"x6". **22.50**
F.O.B. Chicago.



GROBAN SUPPLY CO. Dept. PM-3
1139 S. WABASH AVE., CHICAGO 5, ILL.

ORDER DIRECT FROM AD SATISFACTION GUARANTEED SEND PAYMENT OR PURCHASE ORDER TODAY
TO PLACE PHONE ORDERS CALL Webster 9-3793

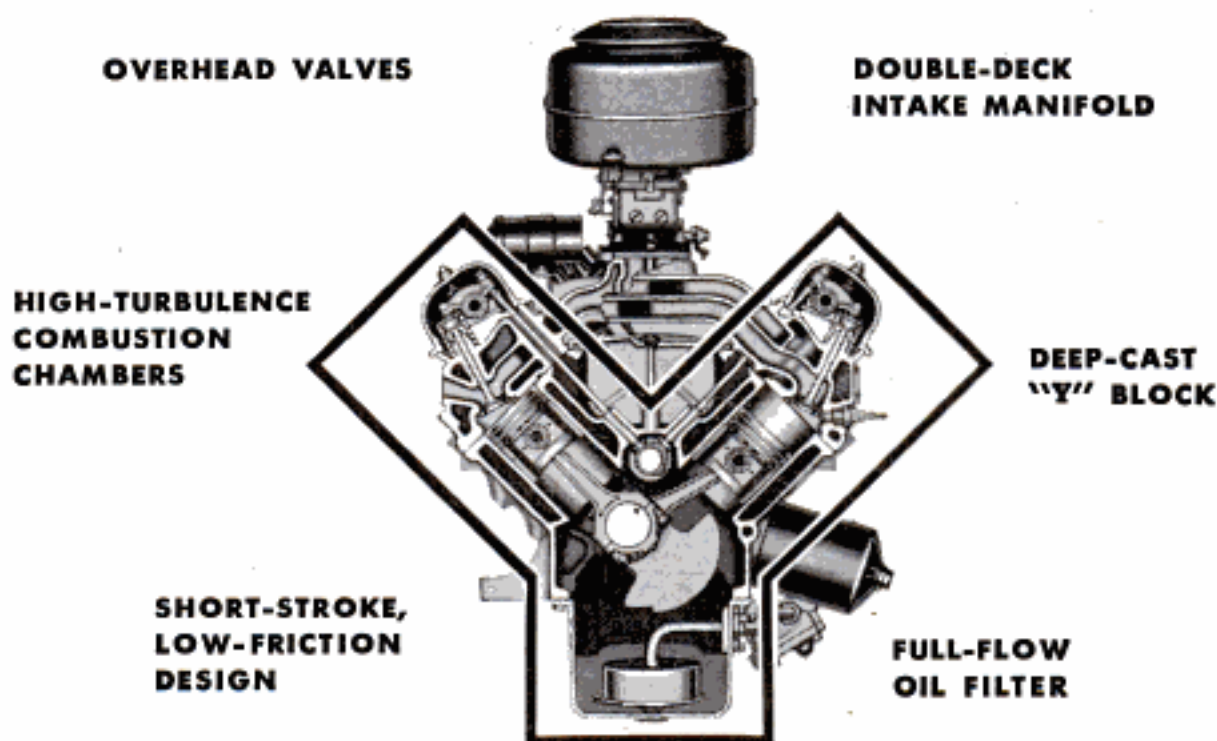

THE NEW 130-h.p. Y-block V-8

The story behind Ford's "Y" and "I" . . .

the two most modern engines in the industry

Twenty-two years ago Ford introduced the first V-8 in the low-price field. The basic design innovation then was the one-piece cylinder block . . . a design characteristic that has since been adopted by all other builders of V-8 engines. And now, with 22 years' experience building V-8's, it is only logical that Ford is first in its field to introduce a brand new type of V-8 . . . the Y-block V-8—along with the industry's most modern Six . . . the I-block Six.

Deep-block construction

Both engines have extra-deep blocks that

extend well below the crankshafts, forming the "Y"- or "I"-shaped cross-sections. This results in far more rigid support for the crankshafts. Operation is far smoother and quieter, engine life far longer.

Free-turning overhead valves

Both engines have overhead valves that, in conjunction with their new intake manifold, permit free flow of *full* fuel charges to *all* cylinders for more responsive performance. Valves are free-turning to help maintain their tight seal, keep compression high for continued top efficiency.

Try the "Y" and "I" at your

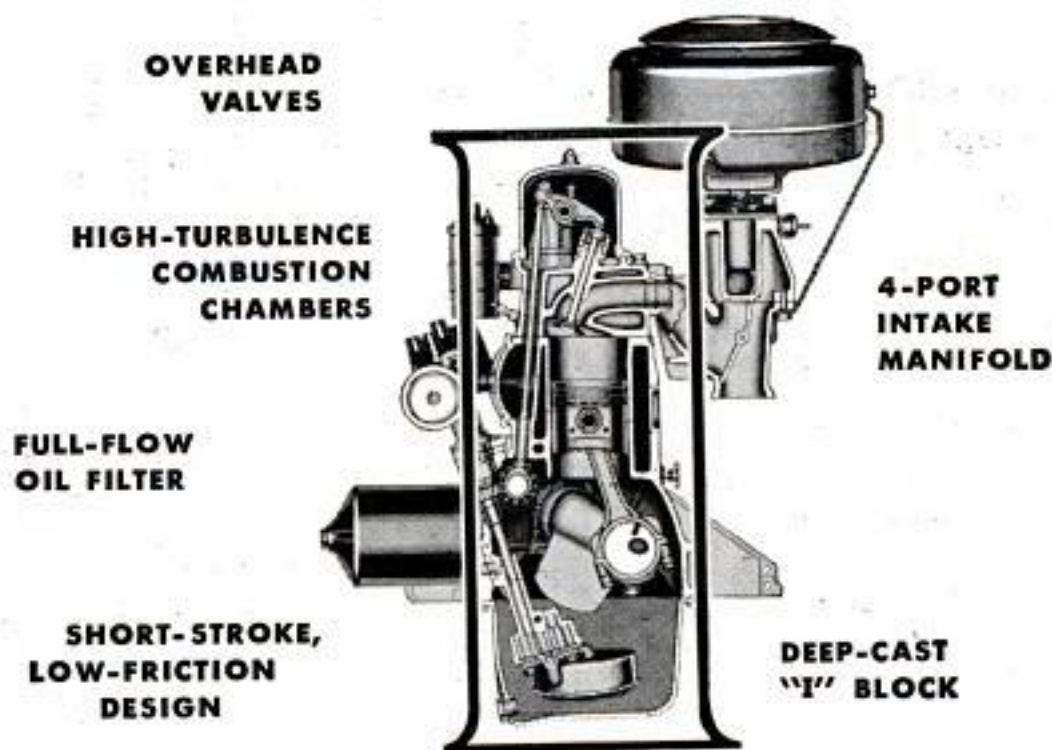

THE NEW 115-h.p. I-block SIX

Short-stroke, low-friction design

Both engines are "oversquare," that is, the bore is greater than the stroke. The short-stroke design means less internal friction, more usable power from every drop of gas.

Full-flow oil filter

A full-pressure lubrication system with full-flow oil filter forces completely filtered oil to all vital bearing surfaces and engine parts. Engine wear is reduced up to 66%.

Base-mounting of oil filter eliminates external oil lines.

Choice of engines

Either the Y-block V-8 or I-block Six is available in any of Ford's 14 brilliant new body styles . . . and you may choose Fordomatic Drive or Overdrive, if you wish. Stop in at your Ford Dealer's soon and Test Drive a '54 Ford with either of these great new power plants.



Ford Dealer's today!

'54 FORD

(Continued from page 10)

from the edge of a high bank on our property in Auburn, Mass. I am quite certain that this shortened her life immeasurably.

At any rate, the maiden flight progressed well for a time. The craft handled surprisingly well and I was quite happy until I had completed about half the distance to the intended landing area in a group of bushes.

At this time, the tacks holding the forward edge of the upper-wing covering tore loose. The additional strain then did likewise to the lower wing and I was left without any visible means of support. As things began to let go, I decided to avoid being involved physically in an airplane crash, so I bailed out and landed in a snow bank. I am sorry to say that the remains of my glider were not so fortunate and the craft was a total loss.

As Mr. Hall stated, your magazine has provided an opportunity for quite a bit of fond remembering. My flight took place in the early '40s. May I say that I sincerely hope that PM's other "aviators" had better luck with their flights than I?

In closing, I would like to add that *Popular Mechanics* has held a position of considerable importance in our household for more years than I have lived. My father,

John A. Blaker, of Auburn, Mass., has been a reader, and occasionally a contributor of shop tips, since the teens.

Alfred A. Blaker,
Berkeley, Calif.

To the Editor:

Your article, "PM Glider, 1909 Model," recalled to my memory my attempt at this model glider.

I built one to one-half scale; I used this model as a kite and it was very successful and had good lifting power. My brother and I built a good-size parachute and would send our tomcat up for a ride. We used a special knot to fasten it onto the glider and when the glider would get up a couple hundred feet, by a few quick jerks on the cord, Mr. Tomcat would come drifting slowly down to earth.

Our parents finally put a stop to our experiment as the cat could not tell us if he liked this kind of sport, although I know he lived a good many years after his parachute rides.

H. E. Webb, Sr.,
Chicago.

Survival, He Says

Time was, and not so long ago either, when a fellow had to get out and get under

(Continued to page 260)

LOOK FOR THE CUPS!

REMOVABLE
R·O·W
WOOD WINDOWS

The advertisement features a photograph of a woman in a white dress removing a window sash. Orange arrows point to the sash guides. A circular logo contains the text 'REMOVABLE R·O·W WOOD WINDOWS'.

You can identify genuine R·O·W removable windows by the distinctive cups. These cups in the sash guides house the tension-adjustment screws.

This simple adjustment insures snug operation—full weather protection. Many competitors have tried to imitate R·O·W window construction. None have achieved R·O·W window quality.

In this illustration, sash have been removed entirely for easy washing of the storm windows.

See your local lumber dealer or write **R. O. W. SALES CO.** 1326-80 ACADEMY AVENUE • FERNDALE 20, MICHIGAN

R·O·W is the registered trade-mark of the R·O·W. Sales Co.

TRY **MONTA MOWER**
on YOUR OWN LAWN
on *Approval!*
9 1/2 LBS.



TRIMS AS IT MOWS!
SPECIAL TRIAL OFFER

Save time and labor! Actually "Two-Tools-In-One", the versatile MontaMower is an amazing work saver! Try it on your own lawn, on our Special On Approval Trial Offer! Its live, precision mechanism first gathers, then smoothly cuts a clean 16" swath through grass, dandelions, tall lawn weeds. Cuts right up to walls, fences, trees and under overhanging shrubs... practically eliminates hand trimming! Cuts steep banks easily! Cutting discs are now both Self-Cleaning and Self-Sharpening. Drive shaft mounted on permanently lubricated sealed bearings. Hundreds of thousands in world-wide use. Buy direct from factory and save. Owners Cooperation Plan can repay cost. Write today for full details on limited "On Approval... Trial Offer". Sold Direct Only.

MONTAMOWER DISTRIBUTING CO.
PM-43 Keeler Bldg., GRAND RAPIDS 2, MICH.

SPORTING GOODS & BOAT SUPPLY STORES WRITE US FOR DEALER PRICES ON YOUR LETTERHEAD

ESHELMAN BOAT TRAILER
World's Lowest Price
Easy Load & Easy Haul & Easy Launch
ONLY \$79



Write for Catalog
Top quality welded steel construction. Shipped complete with Hi-Speed wheels, tires, tubes, hitch, etc. Write
ESHELMAN CO., Dept. BT-103
119 Light St., Baltimore 2, Md.;
333 N. Michigan Ave., Chicago 1, Ill.;
7070 Hollywood Blvd., Los Angeles 28, Cal.

SILVER SOLDER TORCH & KIT \$7.95
JOINS ALL METALS PERMANENTLY



Do your own repairing. KIT includes one tube silver solder paste and 10 5-in. lengths silver solder alloy. Hot-test ALCOHOL TORCH known 2500° F. flame. Operates in any position, indoors or out. Plus of special fuel included. Complete outfit ready for use \$7.95 postpaid. TORCH alone with plus of special fuel \$6.85. KIT alone \$1.65. Instructions included.
AMERICAN PRODUCTS CORP., 422 S. Dearborn, Dept. 3-C, Chicago

"SNOOPER" GEIGER COUNTER



Super-sensitive! Only 1 1/4 lbs! Fits pocket—uses flashlight battery. Find a fortune in uranium. Order Now! Send \$5.00, balance C.O.D. MONEY BACK GUARANTEE. FREE CATALOG—scintillator and larger uranium and metal detectors. DEALERS WANTED.

2995 COMPLETE
PRECISION RADIATION INSTRUMENTS
2235 PM S. LA BREA, LOS ANGELES 16, CALIF.

Protect your home against power interruptions with an...

ONAN Emergency ELECTRIC PLANT



Provides dependable stand-by electricity for heating system, pumps, freezer, lights, appliances. Keeps home safe, livable. Automatic start and stop. Find out how little it costs!

Write for Folder!

D. W. ONAN & SONS, INC.
8575 University Ave. S. E. • Minneapolis 14, Minnesota

A SIZE FOR EVERY NEED
1,000 to 50,000 watts. Compact, quiet-running, easy to install. Gasoline engine powered.

Atkins Silver Steel Pruning Saws
for quick and easy pruning of small limbs and branches.



Atkins Silver Steel Hand Saws
Get a 12 point saw for fine finishing. Picks up where power tools stop.

For Hobby or Profit

Use ATKINS, the Experts' Choice!

Whatever you need in saws, there's an Atkins *Silver Steel* for the job! Yes, Atkins complete line offers exactly the correct choice for the hobbyist, the home craftsman and the professional carpenter. Nearly 100 years experience goes into Atkins production of the right saw for every cutting job. Ask for Atkins at hardware stores and building supply dealers—you'll get the saw you want at the price you want to pay!

New Atkins Chamfer Chain!



U.S. PATENT NOS. 2,326,854 & 2,622,636

The greatest saw chain development ever! And—"It's The Chamfer That Does It"—an Atkins exclusive. Cuts smooth, fast and straight—stays sharp much longer. Get Atkins Chamfer Saw Chain for the easiest cutting you've ever known—available now for every make of chain saw.

ATKINS **BW**

ATKINS SAW DIVISION, BORG-WARNER CORPORATION
INDIANAPOLIS 9, INDIANA

For a fine finish



...use the right
Behr-Manning® sandpaper



For Wood Furniture

BEHR-MANNING GARNET Paper produces a beautiful hand sanded finish. In grit ranges to provide complete sanding stages from bare wood through undercoats to final finish. Use **BEHR-CAT® Sanding Block** for flat surfaces.



For fine finishes on wood or metal

TUFBRAK SPEED-WET® Paper, used with water or oil, is the professional choice for sanding primers, sealers and undercoats.



For Machine Sanding

BEHR-MANNING ADALOX® Paper and Cloth abrasives stand up under power sanding on any material—wood, metal, plastic. **HANDY PACK** Sanding Discs for portable grinders and drills. **HANDY PACK** Sanding Sheets for "shimmy" sanders. Sanding belts for all popular portable belt sanders.

Other sandpapers also available for every sanding job.

HERE'S THE LATEST SANDPAPER DATA . . .

"SANDPAPER—How to Use and Choose" contains 32 pages of illustrated instructions. Send 10c for your copy to Behr-Manning Corp., Troy, N. Y., Dept. PM-3.

C-7



(Continued from page 258)

to the jeers of "Get a horse!" when his brassy Stoddard-Dayton began falling apart on rutted rural roads. He didn't know how easy he had it. Consider the problems of a fellow driving one of these high-flying jets of tomorrow when it bursts its seams 300,000 feet up. How's he going to get down?

There won't be much time to read the handbook if you wait until trouble happens when you're 50 or 60 miles high, but the



Dr. Fritz Haber

Air Force School of Aviation Medicine has a pamphlet ready for you. It's entitled "Escape and Survival at High Altitude," and the author is Dr. Fritz Haber, erstwhile German aircraft designer, lately a member of the School's department of Space Medicine, and practicing as an

engineer in Baltimore, Md., at present.

One of the things that need not worry you, surprisingly, is the anticipated shock of bailing out into the wind from a rocket ship traveling at ten times the speed of sound. At 300,000 feet, says Dr. Haber, the air doesn't have the dynamic pressure of lower altitudes; you could hop out with the fearlessness of a Rover Boy but your troubles would accumulate on the way down.

Even as low as 63,000 feet, for example, your blood will boil at normal body temperature, so for the first few miles of descent you'll need a sturdy pressure suit and an oxygen canteen. If claustrophobia doesn't annoy you, that could be arranged. But you'll want to hurry down the first 280,000 feet to rejoin the earth's air supply, and in a free fall you're likely to pick up a bit of unwonted speed, say two or three times the speed of sound. Cheer up, the earth's atmospheric cushion will slow you down to about 100 miles per hour—but you won't like the sensation. When you hit the 100,000-foot level, says Dr. Haber, it will feel something like smacking flat on a pool of water with a force of 4 to 300 G—4 to 300 times the force of gravity. Dive brakes, of course, may help.

If you have survived thus far, a parachute might bring you back to earth alive, but we're not promising.

So don't be hasty. These things take time, and the Air Force School of Medicine is working on problems 'way ahead of you.



Nature at its Best

**GENUINE HARDWOOD
PLYWOOD TABLE**

with **WROUGHT IRON LEGS!**
DO-IT-YOURSELF KITS

FUN TO ASSEMBLE! EASY TO FINISH!



- ATTACH LEGS WITH SCREWS FURNISHED.
- SAND TOP LIGHTLY, APPLY FINISH OF YOUR CHOICE.

Top is Genuine White Oak veneer and is available in solid hardwood or airplane-type construction core. Edge veneers are electronically glued. Legs are hair-pin type of $\frac{3}{8}$ " velvet black wrought iron. Dimensions: 34" x 20" x 17 $\frac{1}{2}$ ".

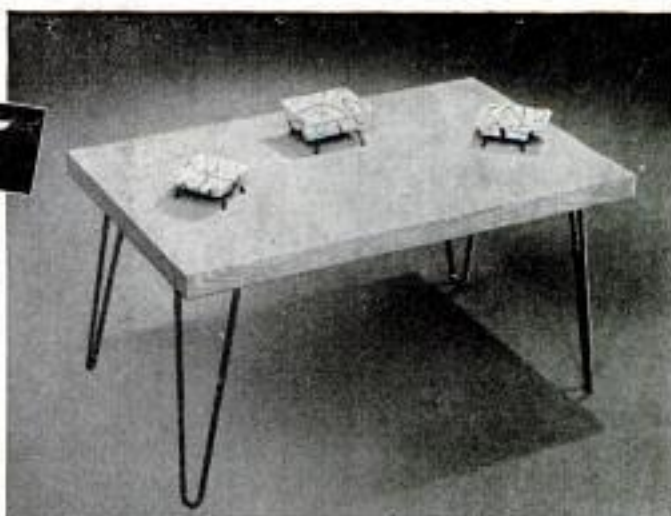

YOU'LL HAVE FUN BUILDING THIS TABLE . . . AND YOU'LL SAVE MONEY TOO! ORDER YOURS NOW!
Price: Hollow Core Kit \$9.45; Solid Core Kit \$9.95.

HOME CRAFT SUPPLY CO., JASPER, INDIANA

Please send express collect _____ Table Kits (Hollow _____ Solid _____). I enclose check money order for \$ _____

NAME _____
STREET _____
CITY _____ ZONE _____ STATE _____

PROTECT YOUR DOORWAY



ONLY \$9.95 tax and 4% S&H

Shipped prepaid with complete assembly and installation instructions.

All-weather protection for your doorways with this beautiful canopy. 48" wide, 31" projection. Ruggedly constructed of top quality, lifetime Redwood, treated with Woodliss preservative. Aluminum hanging strip flashing seals watertight above door. Aluminum drain strip. Order yours, today.

WOLFE PRODUCTS, INC.
71 Elinor Ave., Akron 5, Ohio

Beautifies Your Home

"Architect Approved"

**LUX-AIR
DOOR CANOPY**

**MODERN
LAWN MOWER
SHARPENER**

Service departments of leading Lawn Mower manufacturers use the Modern Lawn Mower Sharpener. One lever moves lawn mower into grinding position. Gasoline and oil remain in engine while sharpening; no dismantling of wheels, roller or handle. The Modern is a precision bed knife grinder—no extra grinder to buy. Imitated but never equaled—Compare before you buy. If it isn't a Modern it can't be Modern (Prices subject to change without notice)

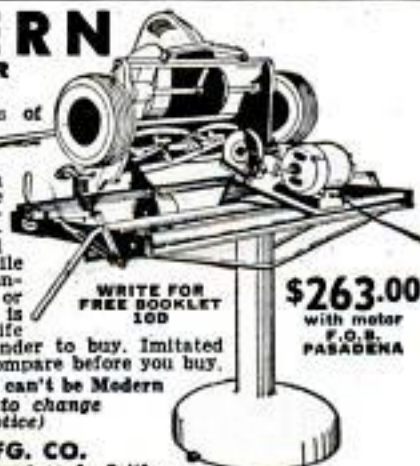

WRITE FOR FREE BOOKLET 100

\$263.00
with motor
F.O.B.
PASADENA

MODERN MFG. CO.
160 N. Fair Oaks - Pasadena 1, Calif.

send for **FREE CATALOG**



America's Foremost
money-making
**MECHANICS'
TOOLS**

It's easy to own the same "pay-off" tools used and endorsed by America's top-earning mechanics throughout the automotive, aviation and industrial fields! Snap-on tools help you handle every repair job faster, easier, better. And they LAST . . . pay for themselves over and over again! Start building your own tool set now with basic Snap-on units—add others any time. Genuine Snap-on tools are never sold in stores—direct to users only. Mail coupon for free catalog.

Snap-on Tools
THE INK OF BETTER MECHANICS

Snap-on Tools Corporation
8062-C 28th Ave., Kenosha, Wis.

Send me free catalog. Occupation _____
Name _____
Address _____
City _____ Zone _____ State _____

Mel Koontz Twists Tigers' Tails

(Continued from page 85)

"If I had nothing to do but break cats for circus acts I'd never think of retiring," he says with a grin. "Naturally I do best when I start with babies. Many a father has found out that if he didn't get close to his youngsters the first few years of their lives he never did. The early, formative period is the time to start doing things with them. It's the same with wild animals."

Koontz began his career in 1925, three years after he moved with his family to California from Kansas. In Los Angeles they lived near the old Selig Zoo, the first organization to supply wild-animal actors for films. The 15-year-old former farm boy hung around the zoo, doing odd jobs, until he was hired as an animal handler. Two years later he began his association with Jackie, the original Metro-Goldwyn-Mayer trademark lion that became the most famous four-legged star in Hollywood history. Before his death in 1952, Jackie appeared in over 500 films, beginning with a Tarzan movie in the late '20s and ending with comedian Harold Lloyd's "comeback" picture, *Mad Wednesday*. His son, Jackie II, in addition to his stellar performance in *Samson and Delilah*, has been seen in *Androcles and the Lion*, *The Lion and the*

Horse and many other movies. His grandson, Jackie III, began his film career two years ago in *Fearless Fagan*.

Mel Koontz trained each of the Jackie lions from birth. Old Jackie was the first jungle cat to work in close proximity to screen stars without chain, fence or other protection for the players. Other trainers claimed Koontz had a freak animal but he proved them wrong by accomplishing the same feat with a tiger and eventually with a black panther, considered the least likely member of the cat tribe to be successfully trained.

In the past 15 years, few film scenes involving animals have been faked because the documentary style of modern movies has made audiences critical. With 3-D and large-screen productions there has been even less faking, as depth makes it easier to detect an attempt at deception. The studios spend a great deal of time, effort and money on realism. When it comes to Mel Koontz and the educated animals of the World Jungle Compound, the realistic results justify all three.

"Sometimes a studio executive will question the expenditure of several thousand dollars on jungle scenes," Trader Horne reveals. "In such cases, we point out that our actors are dependable but that there's

(Continued to page 264)

Buy EVANS for EXTRAS

in 6, 8, 10 and New 12 Foot
"WHITE-TAPES"

This is the BUY for your money — the original, reasonably priced "White-Tape" by EVANS. Your measuring tape dollar goes further! Chrome plated, sturdy case. Snow-white Bonderized steel blades with jet markings, easy to read, last longer. Velvet push-pull action. Instant change replacement blades available. 12-foot size, made only by EVANS, has convenient new blade markings in feet and inches as well as regulation inches.

Evans & CO. 410 Trumbull St., Elizabeth, N. J.

EVANS, THE LARGEST PRODUCERS OF STEEL TAPES WORLD-OVER



Sold Only Through Retailers



THE HEAD CAN'T FLY OFF! Estwing "Unbreakable" hammers and hatchets are forged in one piece from tough tool steel. Grip is genuine leather, proven most comfortable and durable. Used by the carpenters for 30 years. Ax \$4.50, hammer \$3.65. At all leading hardware stores. Write for FREE catalog, **ESTWING MFG. CO** Dept. P, Rockford, Ill.

KING MIDGET AUTO

Operate it for 75c per week. Amazing performance. Surprising comfort. All steel construction. Ready to run or assemble it yourself with our bolt together parts. Rider Agents wanted. Send 25c for detailed literature or \$1 (refunded first order) for actual assembly book and service manual filled with photos, drawings, specifications, etc.

MIDGET MOTORS MFG. CO., ATHENS, OHIO

WORLD'S
LOWEST PRICED
2 PASSENGER AUTO



REPAIR THAT CHAIR YOURSELF SAVES TIME & SAVES MONEY

Don't send good chairs, tables, household articles to the attic or cellar when they need repairing. Instead, get a bottle of Rogers Glue. It's easy to use . . . mends firmly and securely — because only the finest materials are used in making Rogers Glue. Take advantage, too, of this special offer. Send 15c for a full-sized jar of Rogers Glue plus a set of Project Plans. These plans give many illustrations with easy-to-follow directions for making furniture, household articles and toys. They include instructions, too, for setting up a simple workshop. But whether building or repairing, use the glue that gives you the best results — Rogers Glue. Ask for Rogers Glue at Your Local Hardware Store.



"A Ton of
Strength in
Every Drop"



Beautiful Wood Paneling like this costs so little to have!



**Distinctive Weldwood Plankweld®—
guaranteed for life—easy to install—
see it at your lumber dealer's now!**



DO IT YOURSELF Plankweld is genuine wood wall paneling, factory prefinished to soft deep lustre. Ready for immediate installation; each package contains special metal clips which are nailed to wall to hold panels in place. Panels are edge grooved and overlap to conceal clips and nailheads. If

you can hit a nail or saw a piece of wood you can install Plankweld easily. Can be installed on any nail-holding wall or directly to studs without furring. *Plankweld is guaranteed for the life of your home!* **CHOOSE THE WOOD YOU WANT.** 16 $\frac{3}{4}$ " x 8' Plankweld panels come prepackaged (108 $\frac{1}{2}$ sq. ft. to package) and are available in birch, Philippine or Honduras mahogany, plain sliced oak, and walnut, $\frac{1}{4}$ " thick. Now you can have a beautifully paneled wall for less than you think. See them all at your lumber dealer's or at any one of the 60 United States Plywood or U.S.-Mengel Plywoods showrooms located in principal cities, or write for complete information.

Weldwood® 

Plankweld Paneling

UNITED STATES PLYWOOD CORPORATION

World's Largest Plywood Organization

Weldwood Building, 55 W. 44th St., New York 36, N.Y. and

U.S.-MENDEL PLYWOODS, INC., Louisville, Kentucky

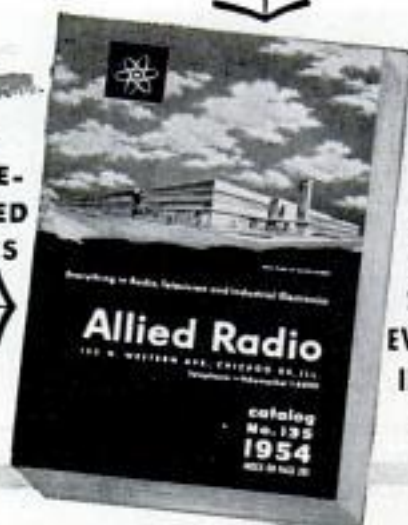
FREE**GET THE WORLD'S LEADING
TV & RADIO CATALOG****ALLIED'S 1954
ELECTRONICS BUYING GUIDE****268
VALUE-
PACKED
PAGES****SAVE ON
EVERYTHING
IN TV AND
RADIO****Everything for Experimenters, Builders,
Amateurs, Servicemen, Engineers
and Soundmen . . .**

Get ALLIED's big 268-page Catalog featuring the world's largest selections of latest top-quality electronic equipment at lowest, money-saving prices. See the newest in custom TV chassis, TV accessories, FM and AM radios, High-Fidelity sound, Amateur equipment, P.A. systems, recorders, test instruments, builders' kits, industrial electronic supplies—plus thousands of parts, tubes, tools and books. Get more for your money—send today for your **FREE 1954 ALLIED Catalog!**



NEW HOME OF ALLIED RADIO
ultra-modern facilities **TO SERVE YOU BEST**

ALLIED RADIO**SEND FOR
FREE
CATALOG**

ALLIED RADIO CORP., Dept. 5-CC-4
100 N. Western Ave., Chicago 80, Illinois
 Rush **FREE** 1954 ALLIED 268-Page Catalog

Name _____

Address _____

City _____ Zone _____ State _____

no guarantee that one of them won't decide to make mincemeat out of Mel. All of the animals must have teeth and claws and, though they may seem tame at times, none could be called a 'pet.' Working in pictures, they're on their own to a great degree and there is always an element of danger."

It's hard to believe that Koontz has had but one serious accident, and that it occurred only last year. For MGM's remake of *Rose Marie* he had to get a mountain lion to leap from a tree onto a horse. The horse was stuffed but the lion was very much alive. It turned on Mel and both fell to the ground, where Mel grabbed a chair but was unable to fend off the animal. His shoulders and arms were chewed and his stomach ripped by its hind claws. When it tore a gash in his forehead his eyes filled with blood but he thwarted its efforts to get him by the neck by holding its jaws apart with his hands. In spite of his injuries he quieted it down and got it into its cage. The accident left him with 18 separate wounds requiring stitches and he didn't work again for seven weeks.

"It would never have happened," he says, "if I hadn't had an eye infection at the time. I was wearing dark glasses and was unable to read the cat's expression. Otherwise I would have anticipated and prevented the attack. There I was, continuing to sweet talk him when I should have been bawling him out."

With no thought of hokum (if anything, he's publicity-shy), Mel reveals what he believes is the reason for his singular success—a natural gift he discovered he possessed when he was about eight years old. On the farm he learned to "read" the minds of animals and more than once saved a pail of milk by knowing in advance that Bossie was going to kick. Nowadays, he frequently gives an apparently innocent animal a severe tongue-lashing or a sharp slap—"not for what he did, but what he was thinking of doing." When a big cat scratches him, in play or in earnest, his reaction is invariable.

"Look what you've done," he'll admonish. "Lick it off. If you don't, I'll twist your tail!"

On many such occasions, spectators who crowd the Compound on an average of 5000 a week are amazed to see the cat comply. Should it hesitate, Mel will make good his threat and nine times out of ten the offending animal will lick his hand, arm or face, thus proving that the so-called "blood craze" of caged wild animals is pure fiction.

Whatever his secret may be, he hasn't been able to pass it on. While he's trained a number of other trainers, none of them has developed his knack for working animals loose in the open. As yet, no one has

(Continued to page 266)

**RELIEVES
HEADACHE
NEURALGIA
NEURITIS PAIN**

FAST



Here's Why...

Anacin® is like a doctor's prescription. That is, Anacin contains not one but a combination of medically proved active ingredients. Anacin is specially compounded to give **FAST, LONG LASTING** relief. Don't wait. Buy Anacin today.

**Last Year's Profit
\$3,000!**

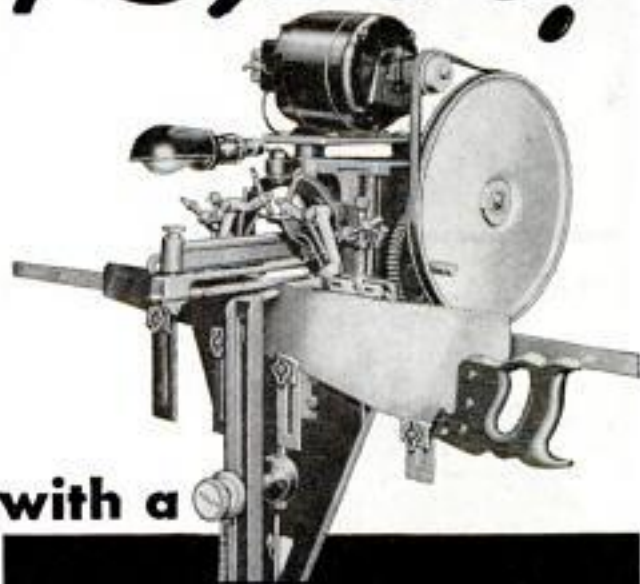

with a

**FOLEY automatic
SAW FILER**

"Last year's profit amounted to \$3,000. Not so bad for a one-man outfit" — from Chas. C. Hough. James B. Williams wrote us—"I made \$765 last year filing saws, and it sure comes in handy. I do this work in my spare time." Men in communities of all sizes make up to \$3 or \$4 an hour with the Foley Saw Filer working full time or part time.

It's no trick to take care of the saw filing for your neighborhood hardware or lumber dealer — plus looking after the saws for farmers, townspeople, manual training departments and factories. The Foley files all hand saws, also band and cross-cut circular saws. It's a repeat cash business, no canvassing, no eyestrain and no experience needed.

**FREE BOOK
Shows How to Start**

"MONEY MAKING FACTS" shows just how you can start at home in your spare time working in your basement or garage. It's an immediate cash business that can develop into a full-time repair shop. Send coupon today — no salesman will call.

Send Coupon for FREE BOOK

**FOLEY MFG. CO., 316-4 Foley Bldg.,
Minneapolis 18, Minn.**

Send me free book
"MONEY MAKING FACTS"

Name.....

Address.....

DINSMORE AUTO COMPASS

Enjoy traveling with America's finest auto compass. Accurate — dependable — trouble-free. Quickly and conveniently mounted on any car. Always insist on a DINSMORE — it's the only compass approved by auto manufacturers. Send for free folder "Pails, Knives, Compasses" and name of nearest Dealer. **DINSMORE INSTRUMENT COMPANY** 1802-25 Kelso St., Flint, Michigan Illuminated

Only **\$5.49**

NEW, IMPROVED CALCULATOR FOR WOODWORKERS only 25c

Instantly gives information on lumber, nails, concrete mixes, painting materials, etc. Convenient, simple to read. Just set dial for nail specifications, to convert linear to board feet, find bit sizes for screws, compare characteristics of woods. 6" diameter heavily varnished cardboard. Send 25c, no stamps, please to Greenlee Tool Co., 2103 Columbia Avenue, Rockford, Illinois.

EASY MONEY FOR YOU!
Sell the Wheelhorse.
Dealerships open! Write today

Wheelhorse

Makes gardening easier — adds to your leisure!

FREE Catalog! Send Postcard today!

Only **\$149.50**
2 h.p. model

You'll buy a Wheelhorse when you compare price... construction... design and ease of handling! Easy to change attachments help you plow, cultivate, harrow, haul, spray, mow, saw, cut, roll, plow snow. Guaranteed! 2, 2½, 3 and 3½ h.p. models. Write!

POND COMPANY

2643-P3 Dixie Way North, South Bend 17, Ind.



FEARLESS FOSDICK
by AL CAPP

HELP!!-I'M BEING KIDNAPPED BY A FIRE-HYDRANT!!

THAT'S NO FIRE-HYDRANT!!- THAT'S ANYFACE, CRIMINAL MASTER OF DISGUISE!!

I AM TOO A FIRE-HYDRANT-A GAY, ROMANTIC ONE - AND I LOVE THIS GIRL!!

CHUCKLE!!-SHE'LL NEVER LOVE YOU WITH THAT MESSY HAIR!!- GET WILDROOT CREAM-OIL, CHARLIE!!- WITH A FREE PLASTIC DISPENSER!!

DRY UP, FLAT-FOOT!!

HA!-A SMART HYDRANT WOULD RELIEVE DRYNESS WITH WILDROOT CREAM-OIL, INSTEAD OF PTU!!- WATER!!

GET THIS FREE PLASTIC DISPENSER (WORTH 50¢) WHEN YOU BUY WILDROOT CREAM-OIL. A \$1.29 VALUE - ONLY 79¢ PLUS TAX. HURRY!!

WILDROOT CREAM-OIL HAIR TONIC

FREE PLASTIC DISPENSER

COIN SCOOP

UP CAP

79¢

Capr. United Feature Syndicate, Inc. 1954

come along who could step into his boots and meet all the requirements of the movie industry. That's why Billy Richards and Trader Horne turn deaf ears whenever he talks about quitting.

On a movie set, Mel's appearance is disarming. Wearing an old slouch hat and scuffed shoes, he looks like a grip or an electrician. When he goes into action he seems something of a psychologist and appears to dominate the animals with will power that is almost hypnotic. When *Tanganyika* was being filmed, I watched him stand 50 feet from Jackie, after getting him to lie down in tall grass. Then, when director Andre de Toth gave the signal, he talked the big cat into picking up a large piece of meat at his feet and slowly advancing toward the camera. What made this all the more impressive was the fact that it was Jackie's regular feeding time.

During his career he has run across only one bit of action called for in the script that did not reach the screen. He trained a team of lions to pull a wagon, galloping them around a Los Angeles parking lot. They were supposed to wind up hitched to a chariot driven by Claudette Colbert in *The Sign of the Cross*, and no one connected with the production was more disappointed than Mel when the technical adviser vetoed the stunt. He drew some consolation from the reason given for the refusal: The Romans simply did not have any animal men capable of turning the trick. ★ ★ ★



Time-Saving Coin Scoop Loads All Denominations

Pennies, nickels, dimes, quarters and half dollars are quickly counted and wrapped with a simple coin scoop. The device consists of a plastic cylinder closed at one end and slit down one side. Adjustable to fit various sizes of coins, it is also marked to indicate the necessary number of coins for wrapping. Once the coins are stacked in the scoop, it's easy to slip the coin envelope around them. Private individuals as well as cashiers find the scoop useful.

ENJOY BUILDING
YOUR OWN

**RADIOS
TRANSMITTERS • AMPLIFIERS
TEST EQUIPMENT**

Heathkit

**COMMUNICATIONS
RECEIVER KIT**

Build your own world-wide radio or choose from over 50 other top quality Heathkits. Easy to build from clear, step-by-step instructions. No specialized knowledge required. Low Kit prices include tubes and all necessary parts. Save money—buy directly from manufacturer.



**MODEL AR-2
\$25.50**
SHIP. WT. 12 LBS.

WRITE FOR CATALOG



**HEATH COMPANY BENTON HARBOR 17,
MICHIGAN**

HOME REPAIR TIP NO. 7



PROTECT FRAYED WIRING from insulation breakdown with the world's finest electrical tape. Plastic backing. Tough, stretchy. Sticks tight. Professional electricians have used it for years. Try it for tool-handle grips, hose leaks, too. "Scotch" Brand No. 33 Plastic Tape—39¢ at your favorite store.

Try it for tool-handle grips, hose leaks, too. "Scotch" Brand No. 33 Plastic Tape—39¢ at your favorite store.



MAGNETS 225# PULL
GENUINE ALNICO—NEVER WEAKENS

AMAZING, PERMANENT MAGNETS—WILL NOT WEAKEN! NON-ELECTRIC
Retrieve guns, tackle, tools and other steel items from lake, river, plating tanks, drains or other hard-to-reach spots. Recover drills, taps, etc. from sweeping. Clear alley of harmful tacks, nails. Many other uses. Pays for itself quickly. **GUARANTEED.** Try any magnet one week. Money refunded if you are not well pleased.
No. M-725 (Weights 5-4 oz.) Has pull of 225 lbs. on steel block. \$18.00
No. M-675 (Weights 4-9 oz.) Has pull of 175 lbs. on steel block. \$10.50
No. M-650 (Weights 4-1 oz.) Has pull of 150 lbs. on steel block. \$ 8.50
No. M-500 (Weights 1-5 oz.) Has pull of 50 lbs. on steel block. \$ 4.00
No. M-30 Hobbyist assortment of six small magnets. \$ 1.50
Send Money Order or Check. We pay postage. No C.O.D.'s.
MIAMI MAGNET COMPANY, 3240 N. W. 27th Ave., Miami 42, Fla.

**CONVERT HAND MOWERS
to POWER MOWERS**

Takes less than 3 hours

The Handy-Dandy Lawn Mower Kit fits any hand mower from the 16 to the 20 inch size. Complete with all necessary parts. Kits can be purchased separately, complete with engines or complete with Pennsylvania mower.



Also manufacturers of complete power mowers (both reel and rotary) and garden cultivator with snap on attachments. Takes less than a minute to change.

LE CLAIRE MFG. CO., Le Claire, Iowa, Dept. PM

new

stationary spool—never turns
—no line twist under load!

new

geared-action drag—extra smoothness, power and long life!

new

oversize drag—adjusts in action without removing hand!



No. 400
\$17.95

new

Bronson Spinit

You never get line twist under load with a Bronson Spinit, because the spool never turns. You'll like it!

And new Spinit geared-action drag works on the crankshaft, not the spool—you always get accurate, steady tension. New oversize button can be adjusted with a fingertip while you play the fish.

See the Bronson Spinit at your sporting goods counter—only \$17.95. Other Bronson and Bronson-made J. A. Cox reeels are priced from \$2.95 to \$33.00.

BRONSON REEL CO., BRONSON, MICHIGAN
(Div. of Higbie Mfg. Co.)



Bronson Royal-Matic
No. 390 • \$10.95

Outworks, outlooks them all—blue-green anodized aluminum, bronze bearings, silent wind, free-stripping with governor-controlled retrieve.



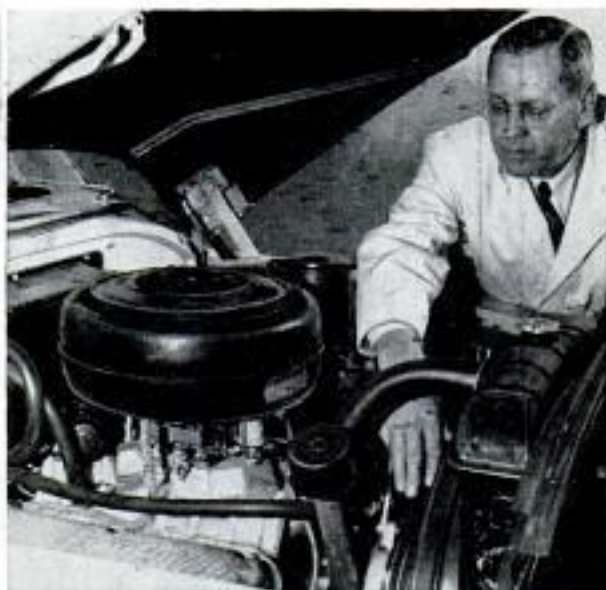

Chrysler's big V8 engine was boosted to 235 horsepower without increasing compression or displacement

The Owners Report on the Chrysler

(Continued from page 96)

carelessness in assembling car."—Chicago mechanic.

"After only 2460 miles my particular car is developing rust spots where it isn't finished off well near chrome and stainless steel. Also the gas filler is in very poor

location."—Miami Beach, Fla., contractor.

A few complained about the location of the rear-view mirror.

"Mirror not placed right. Partially obscures forward vision."—Piper City, Ill., farmer.

Other owners were not pleased with the change-over from needle dials to flashing-light indicators for oil pressure and ammeter gauges.

When asked specifically about this change, 51 percent of the owners said it was good; 20 percent said it was poor; and 29 percent gave an indifferent answer. Here are some comments:

"Good. Easier to see when something goes wrong."—Rockford, Ill., tool and die maker.

"Poor. I would like to know what the generator and oil pump are producing."—Bayside, N. Y., motor-vehicle supervisor.

"It does not give a true picture as you do not know how much the battery discharges. Also you can't see the red warning signals during the day."—Newark, N. J., retired owner.

"Unable to tell if you have too much oil pressure or if battery is overcharging."—Hobbs, N. M., salesman.

When asked to evaluate certain particular features, most owners showed greatest

(Continued to page 270)

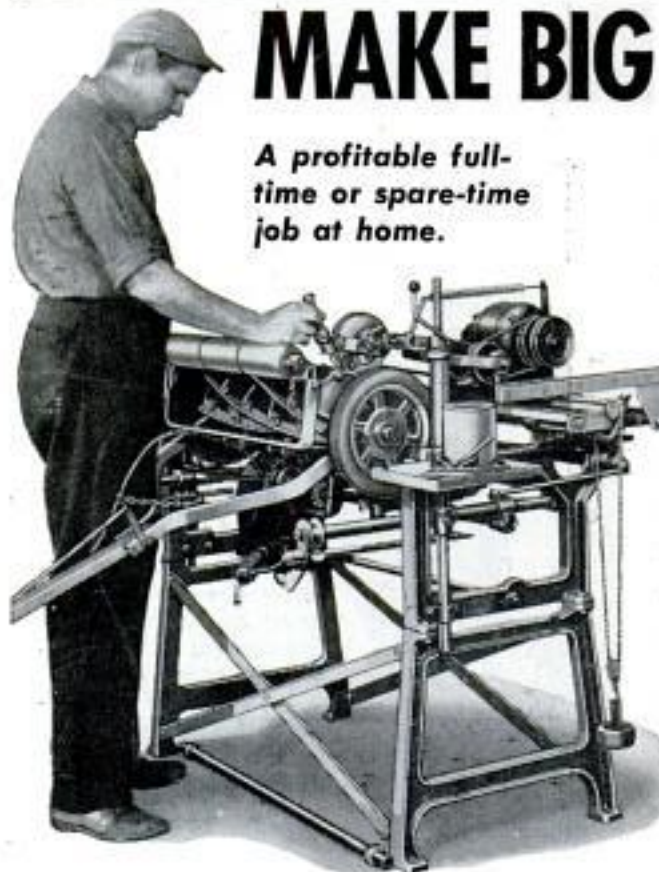

MAKE BIG MONEY GRINDING LAWNMOWERS

A profitable full-time or spare-time job at home.

NO EXPERIENCE NEEDED Simple to set up — easy to operate. Many have sharpened their first mower expertly just minutes after unpacking their Ideal!

NOTHING TO TAKE APART No need to disassemble the mower if you use an Ideal. Put the whole mower in the machine to get a razor sharp edge on bed knife and reel of any mower—hand or power.

USERS PRAISE IT "I have only praise for your machine. My customers think I am a wizard at grinding mowers!"—D. Pemberton.
 "I sharpen lawnmowers only in my spare time and average \$2.50 an hour. I sharpened one in 16 minutes."—F. Murphy.
 "I have sharpened 229 mowers and made \$602.20."—R. Bowman.

HUNDREDS OF DULL MOWERS Ideal users have sharpened over a thousand mowers a year. Mowers everywhere get dull through normal use and a winter's accumulation of rust . . . Get your Ideal NOW in time for the Spring rush. It will pay for itself in no time!

IDEAL LAWNMOWER SHARPENER

Our 52nd Year

For FREE CATALOG Write to: **The FATE-ROOT-HEATH CO., Dept. PM-3, Plymouth, Ohio**



TO PAINT LIKE AN EXPERT

USE THE FINEST BRUSH

FREE BOOK — "How to Do a Good Paint Job?"
Send card (and name of your retailer, if you wish) to Baker Brush Co., Inc., 83 Grand St., New York City 13

Brushes by Baker

AMERICA'S FINEST PAINTING TOOLS

**NO. 210 HAND DRILL!
& PIN VISE \$1.00**

x-acto

KNIVES • TOOLS
HANDICRAFT KITS



X-ACTO, INC.
48-41 Van Dam St.
Long Island City, N. Y.

Send 20¢ for 20-page Catalog

make your own Gems 29.50
F.O.B.

The Gem Maker comes complete with all necessary equipment, including a super-charged diamond blade for sawing, and all wheels for grinding, sharpening and polishing; also complete instructions. The complete equipment as shown, less motor and belt, for only \$29.50, f.o.b., Burlington, Wisconsin. Write today for information and literature.

B&I MANUFACTURING CO.
Dept. 5 Burlington, Wis.



WORLD'S BEST SMALL TRENCHERS



Portable DITCH-WITCH digs 2" to 6" clean, even ditches to 36" depth in all types of soil. Complete unit—self propelled—outdigs 8 men. Four rugged models.

Write for illustrated literature.
THE CHARLES MACHINE WORKS
620 B Street Perry, Oklahoma

All Purpose Holders

HOLD MOST ANYTHING WITH A HANDLE
IN THE HOME, OFFICE, SHOP OR STORE



Also Use for Certain Rods

12 for \$1.00
with Screws

E. & J. ENTERPRISES, INC.
682A Bloomfield Ave., Verona, N. J.



FRAM traps dirt
your eye can't see!

Minute particles of dirt and dust inside your car's engine can ruin vital parts—cause excessive wear . . . shorten engine life!

Fram Cartridges are engineered for *extra high* efficiency to trap these microscopic engine-killers. Fram gives your engine the finest clean-oil protection possible . . . safeguards it for thousands of extra miles . . . saves on repairs.

There's a Fram Cartridge designed to automotive engineering specifications to supply *your* engine with the cleanest oil—at the proper flow rate—at all times. See your garage, service station or car dealer today!

FRAM CORPORATION, Providence 16, R. I. Fram Canada Ltd., Stratford, Ont.



For nearest
FRAM
Dealer Call
Western
Union Operator 25.

FRAM
OIL • AIR • FUEL • WATER
FILTERS

ON TV!

See Fram "Vacationland America" starring John Cameron Swayze on TODAY with Dave Garroway—NBC-TV. Send Fram box top or 25¢ for big, 68-page Vacation Book!



tired of this...

look for this



The Alcoa label tells you at a glance . . . here is today's most modern screening. Screening that will never streak your light-colored window sills and siding, stays good looking year after year, won't rot, sag or burn.

Woven from a specially developed Alcoa® Aluminum Alloy Wire by leading manufacturers, this superior metal screening is available now—for replacement—in standard and custom-made screens, framed or tension type, and in better combination units.

Ask for *Aluminum Screening* made from Alcoa Alclad Wire. Specify its use in the screens you buy. Look for the Alcoa label—your guide to today's finest, long-lasting screening, woven to meet both Federal and National Bureau of Standards Specifications. ALUMINUM COMPANY OF AMERICA, 1931-C Alcoa Bldg., Pittsburgh 19, Pa.

ALCOA 
ALUMINUM

ALUMINUM COMPANY OF AMERICA



ALCOA ON TV brings the world to your armchair with "SEE IT NOW" featuring Edward R. Murrow, Tuesday evenings on most CBS-TV stations.

approval of forward visibility. Least-liked of specific features mentioned was exterior body styling—additional evidence of a feeling stated previously. Only 71 percent said they liked the present body styling. Riding comfort was liked by 92 percent of the owners; rear visibility by 91 percent and interior styling by 87 percent. For additional details on these and other points see the percentage chart that accompanies this article.

Why Did They Buy Chrysler?

In the questionnaire, owners were asked to state why they purchased a Chrysler. The answers were varied.

"I believe it is the best all-around car sold except for exterior styling."—Detroit, Mich., office manager.

"Primarily because of engine principles and design."—Oak Lawn, Ill., engineer.

"My wife liked the color."—a Chicago physician confesses frankly.

"Before deciding, I tried several others. Chrysler was decidedly superior."—Tolledo, Ohio, educator.

Previous satisfactory Chrysler ownership was the most common reason for buying the 1954 models.

Apparently the new Chrysler has converted some new owners because 83 percent say they will buy another Chrysler although only 67 percent have owned one previously.

Over-all, the Chrysler was rated excellent by 71 percent of all owners, good by 26 percent and average or poor by less than two percent each.

As would be expected, most owners of the V8 models rated acceleration as excellent. Windsor owners were less enthusiastic about acceleration.

Suggestions from Owners

Here are some suggestions selected from those submitted by the owners in the poll:

"Armrest on door should have handhold to use in pulling door shut."—Baileyville, Ill., farmer.

"Brake pedal could be wider and closer to the floor board so you don't have to lift your leg from accelerator to brake."—Genoa, Ill., farmer.

"Clock is hard to read and gasoline gauge is not accurate enough."—Tuckahoe, N. Y., manufacturer.

"Don't like tinted glass for night driving."—Gloversville, N. Y., grocer.

"Power steering has hissing noise when turning wheel to extreme right or left."—Smith Center, Kans., chiropractor.

"No ash tray handy for driver."—Perth Amboy, N. J., foreman.

(Continued to page 272)



"I Love to Garden
with my
ROTO-HOE"

**ROTO-
HOE**

of low cost attachments—all easily interchangeable in minutes, and thoroughly "garden Proven." You can pump, spray, saw wood, throw snow, mow, trim, and edge lawns as well as till and cultivate.

GET THE FACTS in our new color catalog, with name and location of nearby dealer.

START YOUR OWN BUSINESS. If you are a mechanically-minded young man who would like to start his own dealer business selling and servicing ROTO-HOEs; there may be an opportunity for you in your community. Write us today.

ROTO-HOE & Sprayer Co., Box 19, Newbury, Ohio

**GET THIS STRAIGHT you can't beat
an EMPIRE LEVEL**



For improved accuracy, better visibility, less breakage, use the new Empire 9" aluminum Torpedo pocket level with machined bottom groove and protected, easy-reading vials. See your dealer today for all-purpose Empire Levels.

EMPIRE

LEVEL MFG. CO. | 10930 W. Potter Rd., Dept. PM
Milwaukee 13, Wisconsin

LAWN ORNAMENT-NOVELTY PATTERNS

28 Lawn Ornament Patterns, 25c. Other Patterns: 15-20" high: Dutch Girl, Dutch Boy, Pirate, Bull Terrier, Mexican Girl, Mexican Boy, Dwarf, Penguin, Flower Girl, 15c each. 25 Novelty Patterns, 30c. All 62 Full Size Patterns, \$1.00.
Strother Pattern Service, Dept. DP-8, Box 128, Bellington, W. Va.



G E A R S

In Stock - Immediate Delivery

Gears, speed reducers, sprockets, thrust bearings, flexible couplings, pulleys, etc. A complete line is carried in our Chicago stock. Can also quote on special gears of any kind. Send in your blueprints and inquiries.

Send for Complete Catalog No. 10

CHICAGO GEAR WORKS
440-50 N. Oakley Blvd., CHICAGO 12, ILL.

REG. TRADEMARK

Dustite GASKET
SEALS METAL CASEMENT WINDOWS



Get year 'round comfort with this flexible sealing lip . . . Keep your home free of Dust, Drafts, Rain and Bugs. Seals and insulates metal contact between frame and window. Controls Condensation where storm windows are used. Ideal for air-conditioned homes. Easily installed!

SAVES FUEL!

See your neighborhood hardware store or write for free sample to



DUSTITE PRODUCTS COMPANY

DEPT. 2 • 6 CANTERBURY DRIVE • DAYTON 9, OHIO

INVENTED IN 1948

**DO-IT-YOURSELF
PROJECT WITH
TRIPLE PAY-OFF**

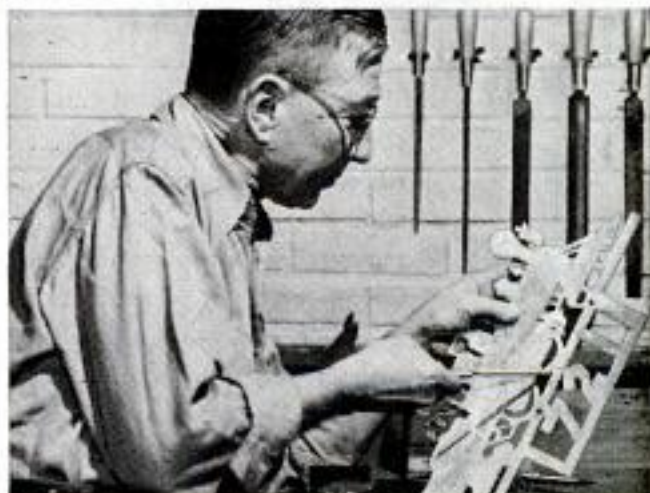

In making his own house sign (for example), this man is (1) saving money, (2) adding to the value of his home, and (3) having a lot of fun doing it.

What's more, his pride of achievement is heightened by his possession and use of *good* files. They're NICHOLSON. This and BLACK DIAMOND are the most famous two brands in the world.

He knows their teeth are sharp, evenly high, of uniform hardness, and have extra-long life. They're the choice of both the professional and the exacting amateur craftsman. They've the quality good hardware and tool-supply dealers like to recommend.

FREE—"File Philosophy," Nicholson's famous 48-page illustrated book on kinds, use and care of files. Shows and describes many types of files for use on all sorts of projects comprising hard or soft metals, wood, plastics, etc. **Send for it.**

NICHOLSON FILE COMPANY

22 Acorn Street, Providence 1, R. I.

(In Canada: Nicholson File Company of Canada Ltd., Port Hope, Ontario)



NICHOLSON
FILES FOR EVERY PURPOSE

WEEK-END DECORATORS!

Peel off old paint FOR A BETTER JOB



Why try to paint over a cracked, checked or broken finish . . . when it's so easy to "peel it off" with Klean-Strip? This modern remover leaves the surface clean, smooth and dry — ready for a

better, longer-lasting paint job. Non-inflammable Klean-Strip works fast on all type finishes. Needs no afterwash or neutralizing . . . saves labor and materials. Buy it when and where you buy paint.

Made by The Klean-Strip Co., Inc.
2340 S. Lauderdale, Memphis 6, Tenn.
KLEAN-STRIP TAKES OFF ANY FINISH

Now build
this attractive
**Valance-
Bookcase**
with minimum
cost and effort



MAKE it at home . . .
... with **HOMASOTE**

This distinctive piece serves 3 desirable functions: the bookcase, framing the window, puts to work small spaces around the window; the big bottom shelves hold record albums or large books; the valance decorates the window top—conceals the curtain rod. *You need no blueprints to build this bookcase.* Our simplified Easi-Bild* Pattern #271 shows how to cut each piece to exact size—how to assemble the bookcase professionally—specifies all materials.

15/32" Homasote is the major material used . . . completely weatherproof, permanently crackproof, America's oldest and strongest insulating-building board. Saws and nails easier than wood, takes any paint or stain. Mail coupon today for pattern and Homasote literature.

*T. M. Reg. Easi-Bild Pattern Company

HOMASOTE CO., Dept. 35, Trenton 3, N. J.
I enclose 50¢ for which send me Pattern #271.

NAME

ADDRESS

CITY..... STATE.....

My lumber dealer is.....

"Power steering is good, although perhaps a little more pressure on the wheel for slight turning would be better."—Burbank, Calif., service-station employee.

"Power steering is best I have tried."—Atlanta, Ga., traveling salesman.

"Power steering is more fatiguing on long trips than conventional steering. Constant juggling is needed to keep car on even keel and in proper lane on highway."—Jersey City, N. J., sales executive.

"Power steering is sensational for parking and getting out of tight places, but at 50 m.p.h., car has tendency to travel right to left slightly."—Bronx, N. Y., salesman.

"Chrysler's air conditioner is by far the best in the field. In Texas, I owned two other cars and their units are not in the same class as Chrysler's."—Colorado rancher.

And now for my own test—The car tested was a 1954 New Yorker DeLuxe four-door sedan with PowerFlite transmission. I drove the car 832 miles from Los Angeles to San Diego, and return, to Santa Barbara and return, and then over the mountainous Lake Arrowhead route which included some off-highway testing in the Mojave Desert. Thus a variety of driving conditions resulted.

Chrysler's engineers deserve credit for boosting last year's 180 horsepower engine to 235 horsepower without increasing piston displacement or compression.

There is little engine vibration at any speed and the 1954 New Yorker DeLuxe is certainly a "powerhouse on wheels" with dynamic performance. The power and acceleration, especially over 30 miles per hour is something to talk about.

The car was equipped with Hydra-Guide, Chrysler's power steering. Dual belts are used to operate the power-steering pump. It operates full time and takes a little "know how." Until one becomes familiar with its operation, he is inclined to oversteer as there is no "feel" of the road. I'd prefer a little pressure against the steering wheel in my power steering.

The car handled wonderfully well for a large automobile around the winding roads in the mountains. In the desert, the ease of cruising and top speed were remarkable. On a back-road test the speedometer hit 121 miles per hour (approximately 113 miles per hour actual speed), which places Chrysler well at the top of 1954 performers.

As in many cars, there is a sensation of front-end "floating" at high speed and some roll on corners, but Americans seem to prefer this soft ride to the harder springing and better cornering characteristics of foreign sports cars.

(Continued to page 274)

BUILD YOUR OWN MOTOR SCOOTER!



PRICE COMPLETE **\$39.95** F.O.B. ST. LOUIS, MO.

The Hurricane Scooter Kit comes to you complete as illustrated, ready for the motor. This scooter will perform beautifully with a motor from 1 h.p. to 1½ h.p. with speeds up to 25 miles per hour. Will carry a 200-lb. load. Not a toy, but a sturdy, medium-sized all-steel scooter. Kit includes everything except motor.

Send post card for descriptive folder.

ST. LOUIS PRODUCTS CO., BOX 24-P, NORMANDY 21, MO.

MAK-A-LITE

PERMANENT STEEL ASSEMBLY TO MAKE POWERFUL, PORTABLE LIGHT

No Moving parts; one minute to assemble. With screwdriver, hook up with 6-volt battery and a 95,000 c.p. light. Light draws 4¾ amps; battery lasts indefinitely. To order "MAK-A-LITE", send us \$1.00.



NO C.O.D.'s

BARNES-DIVINE MFG. CO., INC.
425 S.W. 24 Oklahoma City, Okla.

BETTER
BUILT



Precision built to perform better over the years. Free catalog.

GERSTNER TOOL CHESTS
454 Columbia St. Dayton 7, Ohio

FREE BOAT KIT CATALOG

12 ft. Runabout

- Assemble your own boat
- No experience necessary
- Save 1/2 to 2/3 "factory built" prices
- Prices include freight and paint

Models from 39.25 complete



Marine Hardware & complete accessories

LUGER INDUSTRIES Kit Division 3207 FREMONT AVE. 50 MINNEAPOLIS 8, MINN.

The Modern PLASTIC for lasting Home Repairs

PERMANENTLY mends cracks or holes in wood, tile, stone or plaster. Sticks and stays put—Does not chip, shrink or fall out. Easy to use. Economical. Mold it, chisel it, polish or paint it. If unobtainable from your lumber, paint or hardware dealer, the big 4-lb. can will be sent you post-paid (in U.S.) for only \$1.25. Full money-back guarantee, order now.

DONALD DURHAM CO.
203 School St., Des Moines, Iowa



AMAZING TOOL for ELECTRICAL WIRING

Wherever there is an Electrical Connection there is a USE for this PRECISION ENGINEERED, PROFESSIONAL WONDER TOOL

CRIMPS

Solderless TERMINALS and CONNECTORS

In one simple, easy operation this wonder tool crimps terminals and connectors for safe connections. Supply of Terminals and Connectors included with Tool free.

CRIMPS



SPLICES



SPLICES WIRE

Makes quick, firm splice in damaged wire, preparing it for connector and crimping. Completed splice with connector is firm, neat and safe.

CUTS



CUTS WIRE

Makes a sharp, clean bite through wire and insulation, leaving no loose, scraggly conductor strands.

STRIPS



STRIPS WIRE

Cuts through insulation, and when loose fabric is pulled off, leaves wire strands clean and bright and of proper length.

EXTRA FEATURE SHEARS BOLTS

Bolt snaps off clean, leaving no damage to threads—no burrs to file. Cuts steel or brass bolts.

FREE with Tool Terminals and Connectors in assorted sizes.

Thousands in Use

Electricians, garage and service station mechanics, maintenance men by thousands depend on this wonder tool for all wiring work. It is made of high quality tool steel and is needed by every home craftsman. Satisfaction guaranteed or money back. Send check or money order for \$3.95. Post Paid.

Aircraft Marine Products, Inc.
1315-M American Bldg.
Cincinnati 2, Ohio

formerly \$5.00
Reduced to
\$3.95
POST PAID

1954 CHRYSLER SPECIFICATIONS

ENGINE

	Windsor DeLuxe	New Yorker	New Yorker DeLuxe
Type	6-cyl., in-line, L-head	8-cyl., V-type, OHV	8-cyl., V-type, OHV
Bore and stroke.....	3-7/16 x 4¾ in.	3-13/16 x 3½ in.	3-13/16 x 3½ in.
Piston displacement.....	264.5 cu. in.	31.1 cu. in.	331.1 cu. in.
Compression ratio.....	7.0:1	7.5:1	7.5:1
Brake horsepower.....	119 at 3600 r.p.m.	195 at 4400 r.p.m.	235 at 4400 r.p.m.
Transmission	3-speed unit standard PowerFlite automatic drive optional extra	PowerFlite automatic drive standard	PowerFlite automatic drive standard

CAPACITIES

Oil	5 qt.	5 qt.	5 qt.
Water (with heater).....	16 qt.	26 qt.	26 qt.
Gasoline	17 gal.	20 gal.	20 gal.

GENERAL

Steering ratio (over-all).....	25.8:1	25.8:1	25.8:1
Steering wheel (lock to lock).....	5	5½	5½
Turning diameter (curb to curb).....	41 ft. 9 in.	41 ft. 9 in.	41 ft. 9 in.
Brakes	Conventional hydraulic with bonded linings.		Conventional hydraulic with bonded lining.
Tire size.....	7.60 x 15	8.00 x 15	8.00 x 15
Recommended pressures.....	24 lb. front and rear	24 lb. front and rear	24 lbs. front and rear
Shipping weight (4-dr.).....	3685	3955	4060 lb.
Wheelbase	125½ in.	125½ in.	125½ in.
Tread, front.....	56-5/16 in.	56-5/16 in.	56-5/16 in.
Tread, rear.....	59¾ in.	59¾ in.	59¾ in.
Height, over-all (4-door unladen).....	64¼ in.	64½ in.	64½ in.
Width, over-all (4-dr.).....	77½ in.	77½ in.	77½ in.
Length, over-all (4-dr.).....	215½ in.	215½ in.	215½ in.
Road clearance.....	7¾ in.	7¾ in.	7¾ in.

INTERIOR DIMENSIONS

Front-seat width.....	61½ in.	61½ in.	61½ in.
Rear-seat width.....	60⅞ in.	60⅞ in.	60⅞ in.
Headroom, front.....	36½ in.	36½ in.	36½ in.
Headroom, rear.....	36 in.	36 in.	36 in.
Legroom, front.....	43½ in.	43½ in.	43½ in.
Legroom, rear.....	41¾ in.	41¾ in.	41¾ in.

The Oriflow shock absorbers do a good job of controlling the ride and, even on the hardest bumps at high or low speed, it was impossible to make the front end hit bottom. Chair-high seats, which Chrysler products have used for years, and air-foam rubber cushions help give an extremely comfortable ride.

Chrysler has long had excellent brakes. I noted little tendency to fade in mountain or high-speed driving. The test car had power brakes and, while the operation is extremely smooth, the short movement of the brake pedal makes the operation very sensitive.

Chrysler's parking brake is external-expanding and easily applied by the left-hand lever—but I can't get enthusiastic about its location (at the rear end of transmission). I prefer a parking brake with two units operating on rear wheels.

The interior of the car is luxurious with functional crash pads that extend across the top and bottom of the instrument panel. The top of the panel has a dull finish, which does not reflect the sun—an excellent arrangement both for safety and comfort.

The driving position is comfortable and the instruments are located directly in front of the driver and can be seen easily as there is no upper-half horn-ring obstruc-

tion. Chrysler now uses red warning-light signals to indicate low oil pressure and battery discharge. I'd prefer gauges with indicators to show what is happening to oil pressure and generator output.

Chrysler's fresh-air system is particularly good, letting cool air in through an opening at the top of the cowl just in front of the windshield. This, in my opinion, is much better than an arrangement in which air is drawn through ducts up from the grille, as on many other makes. The ventilator is operated by the foot. The vent pedal, however, is attached to the lever with two screws. On the test car, these screws worked loose twice and the pedal flopped around. It would be better if this foot pedal were permanently attached to the lever.

The body is solid and I found no water leaks. It is remarkably free of rattles and squeaks.

I found some hood flutter over rough roads and at extreme high speeds, which could be reduced by using a shorter, more sloping, stubby hood. With the V8 engine, Chrysler could have a shorter hood to improve ground vision in front of the wheels.

As in all makes of automatic transmissions, the Chrysler owner must expect slightly less mileage than if his car were

(Continued to page 278)

Build this home yourself!



Pay less... Put extra dollars in the bank

Panelized, ready for easy erection right on your lot. Pagemaster, with 20 years of building know-how will help you to plan and select the house that best solves your home building problems. You can plan your home just the way you want it! Pagemaster will help to assure you of the right house size, the desired styling with the best possible room arrangements. Pagemaster, the home-building pace setters use only top quality, nationally advertised materials and equipment throughout—measured, cut and sub-assembled right at our factory. Pagemaster eliminates costly on-the-job errors. Whether you do it yourself or have someone to help, you'll build in less time, use less labor with less waste and for far less money.

THE 601 MERRIL—Excitingly new 1137 sq. ft. exclusive of garage and sheltered walk-way dimensions. Additions and expansion possibilities unlimited.

\$5,723.00



All Pagemaster prices are freight paid in 11 mid-west states. Slightly higher in other areas.



Compare 3 Ways... PRICE STYLE VALUE

... and your choice is bound to be

Pagemaster HOMES

"PANELIZED FOR EASY ERECTION"

Send 25c and coupon TODAY! Get full-color catalog on complete line of new home designs.

PAGEMASTER HOMES

300 Pierce St., Shakopee, Minnesota

Gentlemen: Send your full-color catalog of beautiful Pagemaster Homes. 25c in coin is enclosed.

Name _____

Address _____

City _____

State _____



BUY THE FINEST Metal Boxes
... FOR EVERY SHOP USE

• Designed to meet exacting requirements of tool experts in every phase of automotive, radio, electrical, and industrial work. Unmatched for lightness, strength, beauty, durability. See them at your hardware dealer now or write for free catalog.



WATERLOO VALVE SPRING COMPRESSOR CO., WATERLOO, IOWA

MACHINISTS...

Get this

Free

"New Tools" Catalog



NEW LUFKIN PRECISION TOOLS Can Make Your Job Easier!

New Lufkin dial indicators, wigglers, radius gages, trammels, machinist levels and Mini-Mite magnetic base tools combine the latest design features with years of experience to give you accuracy, durability and speed.

255 Mail the coupon today for illustrated catalog
BUY LUFKIN TOOLS AT YOUR HARDWARE OR TOOL STORE

MAIL TODAY

LUFKIN RULE CO., Saginaw, Mich., Dept. PM
Please send me your FREE "NEW TOOL" Booklet

Name _____

Street _____

City _____ State _____

jari POWER SCYTHE (SELF-PROPELLED)

Cuts easily through heaviest high growth of weeds, brush, grass, even 1 inch saplings. Large wheels work over rough ground. Safe operation, will not throw objects.

Jari Sr. is easy to handle, ruggedly built to perform where other power machines won't. If you have a tough cutting problem, it will pay you to investigate Jari.

3 models to choose from—Attachments for reel cutting, spraying and snow plowing. Write for complete information.

jari PRODUCTS, INC.
Dept. 2940-D, Minneapolis 8, Minn.



CUTS WEEDS TALL GRASS BRUSH

COOL YOUR ENTIRE HOUSE

For as little as
\$139⁹⁵

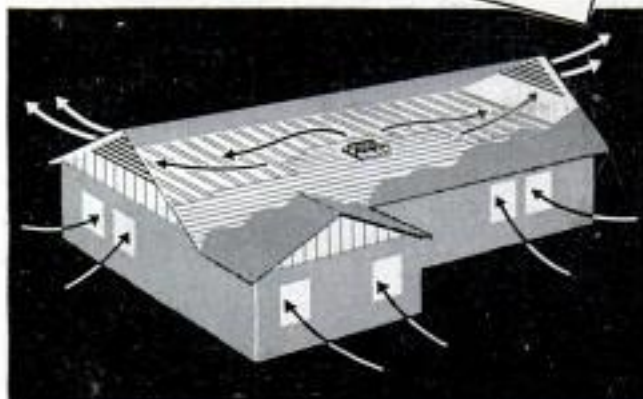

Hunter Attic Fan pulls in cool air through open windows, exhausting hot stuffy air through attic louvers. On hottest summer nights it circulates cooling breezes through every room. Cost of operation is only a few cents a night. Hunter's 67-year experience assures carefree performance. Sizes are available for small or large homes, with prices starting at \$139.95 including automatic ceiling shutter.



You can easily install a Hunter Attic Fan in your home. No special wiring is required. Compact unit requires only 18" to 26" attic clearance. Look in your classified directory and phone the Hunter dealer to enjoy cool comfort in your home at lowest cost. Mail coupon for copy of free booklet.

MAIL FOR FREE BOOKLET

Hunter Fan and Ventilating Company
Box 2858-BJ, Memphis 2, Tennessee
Send a copy of "Change Your Home from Hot to Cool" to:

Name _____
Address _____
City & State _____

HUNTER ATTIC FANS

SAVE \$\$, DRILL OWN WELLS!



Having wells drilled costs plenty! Save by buying inexpensive, lightweight—built for years of service—CON-SOL well driller. Get investment back through rental, contracting, resale. Simple to erect, operate, move. Drills wells, deep or shallow, anywhere—fast. Extra-hard insert needs reworking only after long use. Fully guaranteed for 90 days against defective materials and workmanship. Used by U.S. Depts. of Agriculture and Forestry, U.S. Navy.

For 4" casings, \$385 F.O.B. factory, includes drill, bailer and 100' cable. Additional cable, up to 300', 3/4 hp motor or 1 1/2 hp gasoline engine, available at extra cost. **HEAVY DUTY MODEL**, for 6" casings, available with gasoline engine, at \$1295 F.O.B. factory. Prices and specifications subject to change without notice.



Write for free literature to
Dept. PM-3

CONSOLIDATED INDUSTRIES, INC.
WEST CHESHIRE, CONN., U.S.A.

Make Money
SELLING
Eshelman
Tractors
and doing
GARDEN
WORK

MAKES
PLOWS
CULTIVATES
HARROWS
HAULS
SPRAYS
SAWS
DOZER
MOWS
CUTS
ROLLS
TILLS
SNOW PLOW

ESHELMAN

FOR BETTER
LAWNS

and **GARDENS**

Also Power Reverse. Women can operate it. Free Catalog. Write: **ESHELMAN, Dept. 53**
119 Light St.,
Baltimore, Md.,
333 N. Michigan Ave.,
Chicago 1, Ill.,
7070 Hollywood Blvd.,
Los Angeles 28, Calif.

Erect it yourself and **SAVE!**



- Easily assembled
- Steel or Aluminum
- Garages & Bldgs. for all purposes
- Look like Wood
- Shipped Anywhere

Write for Folder

JOHN COOPER CO., 306 2nd St., HACKENSACK, N. J.

PARTS FOR **MILITARY TRUCKS**

and **JEEPS** 4 & 6 WHEEL DRIVE. WRITE FOR PARTS CATALOG STATING MAKES

American AUTO PARTS CO. INC.

1830 LOCUST—DEPT. PM
KANSAS CITY, MISSOURI

ACE TOOLS



Be permanently
tooled-up for every operation
on your Metal Cutting Lathes.

No. 8-A Ace Tool Set for 9" and 10" Swing Lathes—fits shank size 3/4" x 3/4". Includes Turning, Cutting-off, Boring, Knurling and Threading Tools with high speed cutters, blades and wrenches. 8 complete tools in fitted steel case—nothing else to buy. See your local dealer or order direct.

ARMSTRONG BROS. TOOL CO.
5268 W. Armstrong Ave., Chicago 30, Ill.

\$26⁹⁵

Now! Do Your Own CEMENT Jobs with Ready-to-Use SAKRETE

Cement Mixes in Convenient Bags

Home cement repair and building jobs made easy. Sakrete comes in 3 balanced formulas—concrete mix, sand mix, mortar mix—to give a professional job quickly, economically. Get it at hardware or building supply stores.

Send 10c for 44-Page Book

Page after page of pictures and instructions for patching walks, laying bricks or flagstones, setting posts, fixing cracks in walls, floors, etc. Sakrete, P.O. Box 11, Dept. B-2, Cincinnati 17, Ohio.



JUST ADD WATER

PREVENTS RUST!

3-IN-ONE, unlike most ordinary household oils, actually prevents rust. No wonder 3-IN-ONE outsells all other home lubricants!



"3-IN-ONE" OIL



BUILD FINE GRANDFATHER CLOCK NOW

The simple sensible Red-Ket way as thousands have — SAVE HALF. SHOP TESTED PLANS "SPIRIT OF THE CENTURY" Narrow waist, 8 1/2" tall or stately straight side "SPIRIT OF AMERICA" EASY-TO-FOLLOW pictorial PLANS tell all—plus BROCHURE of heavy brass weight Westminster, tube chime, movements, porcelain dials, 3/4" solid mahogany case kits. Send \$1.00 today — Both plans \$1.50 NOW.

KUEMPEL CHIME CLOCK CO., 27 Kuempel Bldg., Minneapolis 16, Minn.

SEA LEGS PRICES from \$39.00
QUALITY BOAT KITS F. O. B. DEFIANCE, OHIO

PENNEY WOODCRAFT INDUSTRIES

1301-09 Ottawa Ave., Dept. 3-M Defiance, Ohio

Telephones

Desk Stand Style

Slightly used and in excellent condition.

Many Valuable Uses—

Inter-house phones

Loud Speakers

Microphones

Educational purposes

Toys, etc.

Come complete, ready to use.

Wiring Diagrams Furnished.

Two complete for only \$5.00.

TELEPHONE LAMP KITS

Including Telephone, lamp, nipples, push switch, cord & plug together with illustrated instructions \$6.50 postpaid (shade not included).

MICROPHONE Dept. X-1202

1760 W. Lunt Ave., Chicago 26, Ill.



\$2.75

Postpaid in U.S.A.

Two complete for only \$5.00.

Greatest Jig-Saw Value of All Time

Sensational NEW MOTO-JIG SAW

Cuts 1 1/2" wood . . . Has
Built-in Rotary Motor
(Not a Vibrator)



Pat. Appl. For

3,450 cutting strokes per minute



Only \$23.50

CREATED ESPECIALLY FOR THE DO-IT-YOURSELF FAMILY!

The revolutionary new DREMEL Jig Saw cuts 1 1/2" wood, 3/4" plywood fast as you can follow a line — also cuts metal, plastic, etc. New **ROCKER ACTION** principle maintains constant blade tension — cuts faster — lengthens blade life. Powered by a real **ROTARY** motor, it's rugged enough for production work, cuts intricate scrolls impossible for other jig saws. 4-Way Blade Holder saws in any direction — takes any length stock. Has tilting table — foolproof blade guard makes it safe for women and children. Dollar for dollar the new DREMEL out-performs them all!

FAMOUS DREMEL MOTO COPING SAW... LONG TIME FAVORITE WITH CRAFTSMEN!

AMAZING FOOT-A-MINUTE
(7,200 Strokes Per Min.)
CUTTING SPEED!



ONLY \$6.85
with 3 saw blades



FREE PROJECT PLANS

Make your own jig saw. Complete plans and six project patterns. Included FREE.

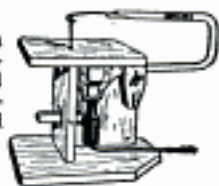

Here is a high speed, electric power tool with hundreds of household and workshop uses! It's so easy to handle women and children love it, yet so rugged it is used by craftsmen, tile layers and carpenters.

Has amazing capacity — easily cuts asphalt and rubber tile, masonite and formica, wood up to 3/4" thick! Perfect for coping and jig saw work, making knick-knacks, toys, other hobby projects. Has high speed reciprocating motor, only two moving parts, never needs oiling. Proved on the job and in thousands of homes.



Cuts scrolls like magic!

SEE YOUR DEALER. If he cannot supply, order direct on 5-day trial, money-back guarantee. Remit in full for postpaid shipment; or send \$2, pay postman balance plus postage and COD.

DREMEL MFG. CO. Dept. 114-C, Racine, Wis.

Your engine's life depends on a film of oil 3 times thinner than cellophane tape!



The vital space between your engine's piston rings and cylinder walls is only 1/1000th of an inch.

Use high-quality Quaker State for the super film that gives greatest oil mileage

SUPER FILM! That's Quaker State's name for the film of oil so pure, so heat-resistant, so high in quality it provides perfect lubrication for your car's engine. Quaker State Motor Oil is refined from 100% Pure Pennsylvania Grade Crude Oil—nature's best. It is the result of 50 years of continuous improvement and specialization in automobile lubrication. Made to meet the extra demands of today's high-compression engines—to give them complete protection.

Quaker State Motor Oil is made to suit the requirements of all makes of cars and for every type of service. Ask your dealer.

ASK FOR...



QUAKER STATE OIL REFINING CORPORATION, OIL CITY, PA.
Member Pennsylvania Grade Crude Oil Association

equipped with conventional transmission or overdrive. I found gas economy satisfactory for a car of its size and horsepower. (See economy chart). Even with the increased horsepower that Chrysler offers for 1954, gasoline mileage was equal, and in some instances better, than my previous test of the 1951-model Chrysler V8—and I attribute this to the new PowerFlite transmission which I rate very high as a well-designed quality unit.

Like all other makes of automatic transmissions (excepting one), the Chrysler unit creeps when the car is "motionless" with lever in Drive or Low with the engine running. It is still necessary to touch the brake pedal to hold the car in a stationary position on level ground.

The PowerFlite affords a full automatic power shift that is extremely smooth when accelerating from zero to top speed. An automatic upshift in Drive takes place between 15 and 65 miles per hour depending upon the throttle opening. The kick-down (passing gear) operates perfectly at speeds below 55 miles per hour when the throttle is fully depressed. The automatic downshift occurs at approximately 11 miles per hour and is noticeably rough.

In tests of the kick-down (passing gear) operation from 30 to 65 miles per hour (when the unit automatically shifts to top gear) I found PowerFlite to be six seconds faster in reaching 65 miles per hour than last year's model with the old semiautomatic transmission. This is certainly a big improvement and an added safety factor.

Of all the self-shifters used on higher-priced cars, PowerFlite is the lightest, weighing 214 lb. Other makes vary from 246 lb. to as high as 314 lb. Chrysler claims that PowerFlite has fewer parts than any other automatic transmission available. There are 185 major parts in PowerFlite, which is considerably less than in other makes. (One make has 295.) ★ ★ ★

New Germanium Transistor

High-frequency radio receivers no bigger than a pack of cigarettes and powered by two flashlight batteries may become standard military equipment. A tough, stable germanium transistor developed by Philco would make them possible. Another use would be in a rescue transmitter built into lifeboats and rafts. As soon as the transmitter unit came into contact with sea water, it would start broadcasting on the international distress frequency. The new transistor, able to handle higher frequencies than other transistors, can be mass-produced with great speed and accuracy.

BUILDER'S HAND SIGHTING LEVEL

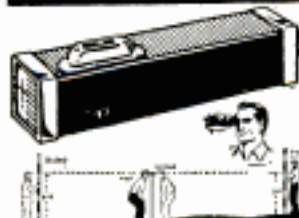

Improved new model, many uses. Establishing foundation lines, laying drains, ditches, roads, terraces, fences, etc. Extremely accurate. Tested by thousands of users. So simple a boy can use it. Indispensable to Home Mechanics, Carpenters, Masons, Contractors, Engineers, Gardeners. Complete with instructions. Item 312. Wt. 3 lb. Factory Special..... **\$2.50**

37 Pc. SOCKET SET



Highest quality, guaranteed non-breakable sockets made by Husky. Beautifully matched chrome alloy. Absolutely the best. Complete range of 17 sockets from 1/4" thru 1 1/2" (1 1/2" drive), 1 extension, reversible 1/2" ratchet, adapter bit, sliding handle, "L" handle, 1/2" speeder, 5 pc. alloy combination wrench set, 8 pc. Allen wrench set, and a big doghouse tool box. We challenge anyone to match this value. Easily won \$41.95. Wt. 14 lb. (Item 59)..... **\$16.95**

44 Pc. SOCKET SET
(Item 59a) Same unconditionally guaranteed non-breakable sockets as above—but with added sizes. Complete range of 23 sockets from 1/4" thru 7/16" (1/2" drive) & 7/16" thru 1 1/16" (1 1/2" drive). Two extensions, reversible 1/2" ratchet, 3 drill punches, sliding 1/2" head, angle coupling, 1/2" speeder, 1 1/2" breaker, 5 pc. high chrome alloy combination wrench set and 8 pc. offset wrench set in big doghouse tool box with ample room for other tools. Reg. \$49.50..... **\$21.95**

52 Pc. SOCKET SET
(Item 203) Contains a complete set of 28 sockets in 1/2" drive, 3/4" drive and 1 1/4" drive, plus all necessary extensions, handles, speeders, reversible ratchets, etc.; all unbreakable, guaranteed against breakage. Beautifully matched chrome thin wall alloy sockets in a big, doghouse steel box. Wt. 17 lb. List price \$62.90..... **\$27.95**

HEAVY DUTY D-C ARC WELDER

Use as portable or stationary welder. Up to 500 amperes. Senior model. Made for years of trouble-free, continuous service. Will handle light or heavy jobs. Easily welds up to 3/8" plate using 1/8" rods. Built-in air cooling system. Arc is easy to strike and hold, because of specially designed arc stabilizer. Hi-lo switch and dial control gives wide range of welding heats. Run welder at 2600 rpm. with tractor, Jeep or 14 hp gas engine or 7 hp elec. motor. Complete with instructions, gas, and triple V belt or flat pulley. You can pay more, but you can't buy a better welder. (Item 28) Wt. 110 lbs. \$400 value at..... **\$99.75**

DUAL CONTROL MODEL same as above but with built-in dual rheostat for low heat soldering, brazing, welding. Special..... **\$119.50**

WELDING KIT Two 10 ft. leads, welding helmet, electrode holder, ground clamp. Sold only with welder at..... **\$10.50**

Send check or M.O. Prices f.o.b. Factory. 10 day Money back guarantee. SEND 10c for..... **MASTER MECHANIC MFG. CO., DEPT. 54E**

Burlington, Wis.

MARCH 1954

BUY WHOLESALE get DISCOUNTS UP TO 85%

PORTABLE LIGHT PLANTS

PUSH BUTTON START A.C. LIGHT PLANT 600-700 watts—115 v.—60 cyc. A.C. Powered by a rugged 2 hp. easy-starting Briggs gas engine. No wiring necessary; just plug in and operate. Plenty of current for any oil burner, freezer, brooder, emergency lights, etc. Which require up to 700 watts. Ideal for Civil Defense, Fire Dept., trailers and camps. Complete with Voltmeter and built-in winding to charge 6 v. auto batteries. Item 24. Wt. 75 lbs. Be prepared if war or storm knocks out power (Reg. \$275 value)..... **\$143.50**

1000-1200 Watt Plant (Item 45) same as Item 24 but larger generator & engine..... \$199.50

350 Watt Plant (Item 273) 115 v. D.C. 1 1/2 hp. Briggs Engine. Perfect for lights, radios, small power tools. Wt. 65 lbs. Factory price..... **\$99.75**

GIANT 2000-2500 WATT PLANT
110-120 v. 60 cyc. A.C. Absolutely the best made—exclusive dynamically balanced structure; heavy windings develop up to 5000 watt overload for motor starting. Also motorized—portable. Powered by easy starting Briggs or 6 hp. Wisconsin engine—complete with all accessories; engine easily disconnected for other uses. Big outlet box, voltmeter, no wiring necessary. Ample current for all purposes. Factory warranty and complete instructions included. (Item 31) Wt. 210 lbs. Reg. price \$580.00. Special at..... **\$299.50**

3000-3500 WATT PLANT (Item 108) 110-220 v. 60 cyc. A.C. Belt drive Wis. Engine. Push button start. Wt. 370 lbs. Heavy duty \$399.50 Generator only for belt drive. Wt. 115 lbs. (Item 198A)..... **\$239.50**

MASTER-LITE 2500 Watt Plant. An ideal plant for vet designed for easy portability. Can be started by rope or built-in 12 v. electric push button starter. Built-in winding to charge battery. Powered by a big 5.10 HP Briggs engine, complete with all accessories. Includes control box, voltmeter, and handy plug-in power receptacles. An ideal plant for AC. Reg. price \$645.00. Factory Price (Item 21)..... **\$329.50**

3500 Watt Plant (Item 23) 115 v. 60 cyc. A.C. Push Button Start. Direct Drive. Wt. 270 lbs. Factory Price..... **\$379.50**

(Item 162) HI-LINE 6000 WATT PLANT
Push Button Start. 115-230 v. 60 cycle A.C. A brute of a power plant with a rugged 14 hp. Wisconsin engine. Plenty of electricity for ranges, water heaters, freezers, pumps, machinery, etc. Affords both 110 and 220 volts. Ideal where heavy current is needed. Wt. 590 lbs. Easily won \$995.00. With self starter, factory price..... **\$645.00**

Same plant but with Crank Start. (Item 166)..... **\$585.00**

Generator and control box only, belt driven. Use your own engine or tractor. Wt. 240 lbs. (Item 163) Factory price..... **\$345.00**

DIESEL LIGHT PLANT
(Item 160) Diesel Master 11-12 kw. 115/230 v. AC. Single or 3 phase. 1800 rpm. direct connected. Electric self-starting. Engineered for permanent power where continuous low cost, heavy duty service is important. Wt. 1150 lbs. Reg. list \$3650.00..... **\$1895.00**

GAS DRIVEN PLANT 115-230 v. 60 10-11 kw. Single or 3 phase, powered by 4 cylinder Wisconsin air cooled engine. Belt driven. Constructed similarly to Hi-line 6 KW shown above but much larger. (Item 217) (with crank start) Wt. 900 lb. Factory price..... **\$1075.00**

Same plant with elec. self-starter..... **\$1145.00**

We make fully automatic controls to operate any of the above light plants. Write for details.

WE MAKE ALL SIZES UP TO 25,000 WATTS

POWER MASTER ARC WELDER

Now a portable, rugged, self-powered industrial type welder with terrific performance, yet at a price hundreds of dollars less than you'd expect. High capacity DC welding unit enables you to tackle any job with confidence—easily handles anything up to 2" plate using 1/8" to 1" rods. Built-in stabilizer and dual control simplifies any welding job from 30 to 250 amperes. Welder is powered by 14HP 2 cylinder air cooled Wisconsin industrial engine with triple V-belt drive. Mounted on a welded steel chassis—easily transported on trailer or pick-up truck. Ideal for shops, factory or farm welding. Complete with instructions and guarantee. Wt. 480 lbs. Compares with welder costing \$1200. (Item 280)..... **\$449.50**

SPECIAL FACTORY PRICE \$449.50

With 1 1/2 hp. motor. Reg. \$199.50. (Item 209Ap)..... **\$129.50**

MASTER AIR COMPRESSOR

COMPARE—This is the only compressor built with a NO RUST stainless steel tank. Safe up to 500 lbs.!

(Item 209) High pressure type for large volume of air for heavy duty service. For paint spraying, inflating truck & auto tires, greasing & the hundreds of other jobs done by compressed air. Piston type. 2" bore compressor with built-in air filter. Master built with high strength alloys and precision bearings and 12" x 24" 2100 cu. in. cap. Equipped with automatic switch that starts and stops motor to maintain desired pressure (up to 150 lbs.) and check valve, safety valve, gauge, shut-off valve, 20 ft. air hose and tire chuck. Beautifully balanced on ball bearing wheels and rubber tires. Don't take chances with used or surplus equipment. Our compressors are factory new and are guaranteed SAFE. Low factory prices. With 1 1/2 HP. 110 v. AC motor. (Reg. \$175) (Item 209p)..... **\$109.50**

With 1 1/2 hp. motor. Reg. \$199.50. (Item 209Ap)..... **\$129.50**

AIR COMPRESSOR ACCESSORIES

Pressure Gauge, range 0-160 lbs. 1/2" pipe thread..... **\$1.50**

Check Valve, solid bronze, 200 lb. pressure, works in all positions. 1/2" or 3/8" pipe threads, (specify)..... **\$3.35**

Pressure Regulator, solid brass, std. 1/2" pipe thrd., reduces any pressure to a range 0-30 psi..... **\$3.75**

Pop safety Valve, adjustable from 0-200 lbs. 1 1/2" pipe thread..... **\$1.40**

SPECIAL all four above..... \$8.95

MASTER GARDENER

NO PUSHING SELF-PROPELLED It's a lawn mower It's a rotary tiller It's a bulldozer It's a cultivator It's a plow

Works for you year round. Prepares mowed, deep seed beds without labor. Built-in power take-off to drive pumps, saws, generators, etc. Safety clutch—can't burn out. More versatile and efficient than tractors costing twice as much. Converts in minutes to Tiller, Power Sickle, etc. Basic self-propelled 2 hp tractor. Briggs or Stratton famous engine..... **\$119.50**

Rotary Tiller..... **\$42.50**

Cultivator..... **\$4.75**

Snow Blow..... **\$29.50**

Disc Harrow..... **\$15.75**

Furrowing Tool..... **\$8.75**

Plow..... **\$15.00**

Rotary Lawn Mower..... **\$42.50**

Sickle Bar Mower..... **\$42.50**

Leaf Blower Blower..... **\$4.50**

Freight prepaid to most areas. Easy payment plan available!

BIG 1/2" DRILL VALUE

1/2" DRILL and 29 Pc. drill set

Now, a big production drill at an unheard of price. Heavy duty 1/2" drill with genuine Jacob's key chuck. Powerful, smooth—drills thru 1/2" steel with ease. 115 v. AC-DC. Written 1 year guarantee. Includes a complete set of 29 tungsten vanadium speed drills from 1/16" to 1/2" by 1/64" in a permanent steel index box. Bits alone ordinarily sell for \$35.00. Drill and bits — certified reg. price \$87.00. Factory..... **\$44.95**

Wt. 15 lbs. DRILL BITS only, regular jobbers length, with index case. (Item 311d) Wt. 4 lbs. **\$11.95**

Neoprene Extension Cord

(Item 185) Heavy duty, No. 14 - 2 conductor, very flexible, 20 yr. quality. Wt. 100 ft. complete with rubber plug and outlet. A terrific buy..... **\$8.95**

Variable Speed Selector

Heavy duty, made by E. F. GOOD-RICH for industrial use. Provides instant speed changes for any drive. For machine tools, presses, printing, production lines, hoists — any operation requiring variable speed. Employs reliable "trouble-free" planetary system. No hydraulics, smooth operation, easy installation. 3 sizes: 1 1/2 hp. wt. 36 lbs.; 1-2 hp. wt. 35 lbs.; 2-3 hp. wt. 40 lbs. Reg. list \$228, \$252 and \$352. Our prices..... **\$79.50, \$89.50 and \$114.50.**

AIR COMPRESSOR ACCESSORIES

Pressure Gauge, range 0-160 lbs. 1/2" pipe thread..... **\$1.50**

Check Valve, solid bronze, 200 lb. pressure, works in all positions. 1/2" or 3/8" pipe threads, (specify)..... **\$3.35**

Pressure Regulator, solid brass, std. 1/2" pipe thrd., reduces any pressure to a range 0-30 psi..... **\$3.75**

Pop safety Valve, adjustable from 0-200 lbs. 1 1/2" pipe thread..... **\$1.40**

SPECIAL all four above..... \$8.95

Send check or M.O. Prices f.o.b. Factory. 10 day Money back guarantee. SEND 10c for..... **MASTER MECHANIC MFG. CO., DEPT. 54E**

Burlington, Wis.

MARCH 1954

Copyrighted material

279

"I went for the Aladdin Angler hook, line and sinker!"

Aladdin
VACUUM BOTTLES
and LUNCH KITS

PINT
QUART

ALADDIN INDUSTRIES, INCORPORATED, Nashville, Tennessee

WOODWORKER'S HANDBOOK

only **15¢**



Full of information, illustrations and bargains on every conceivable wood working item you need at money saving prices.

CRAFTSMAN WOOD SERVICE CO.
Dept. A3, 2729 S. Mary St.
Chicago 8, Illinois
Gentlemen: Enclosed find 15c.
Please send me your big book No. 20.

NAME _____
ADDRESS _____
CITY _____ STATE _____

- Rare and fancy woods, domestic and imported woods, panels, matched plywoods, veneers.
- Multicolored inlay bandings, beautiful natural color inlays and overlays.
- Embossed mouldings, carved ornaments, hundreds of scroll saw patterns.
- Woodworking tools and equipment, cabinet hardware and fittings, more than 1500 items.
- HOW-TO-DO-IT information, projects and ideas. Send for your copy today, the biggest 15c worth ever offered.

START A BUSINESS this Quick Way

"I have taken in 100 mowers in 3 weeks since I got my Foleys", says George C. Wise.

FOLEY LAWN MOWER SHARPENER

Start in spare time and make a quick CASH PROFIT. The Foleys handles up to 3 or 4 mowers per hour—prices run \$1.50 to \$3.00 for hand mowers, \$5.00 to \$8.00 for power mowers. You make 99% profit!

FREE VALUABLE ILLUSTRATED BOOK shows how to sharpen all leading makes of power mowers. Foleys prices are low—easy payments available. **FREE PLAN** tells how to start. Write today—no salesman will call.

FOLEY MFG. CO., 307-4 Foley Bldg., Mpls. 18, Minn.

VARIABLE SPEED HYDRAULIC POWER TRANSMISSION

It has Infinite Speeds 0 to 550. Reverse, Automatic Overload Protection! Adjustable Torque up to 180 inch pounds. 3/4" Input and Output Shafts. It will handle 1/2 to 1 1/2 H.P. Motor. Case measures 7 1/2" long, 7" high, 6 1/2" wide. **VALUE OVER \$300. Shipping Wt. 25#. On C.O.D. orders we require a 10% deposit.**

\$54.50

only Feb. Chicago

DIRZIUS MACHINE SHOP "L" 1423-25 So. 52nd Ave., Cicero 50, Ill.

SEND FOR OUR NEW CATALOG

SAVE ON SURPLUS TOOLS & EQUIPMENT!

Choose from many hundreds of new and used Gov't. and industrial surplus tools, equipment and supplies at a fraction of their normal cost! Write today—send 10c with your request for Catalog B to

T&T TOOL CO. 7667 GRAND RIVER DETROIT 4, MICH.

Print Your Own

Cards, stationery, circulars, tags, labels, photo and movie titles, advertising, etc. Save money. **Print for Others, Good Profit!** (easy rules sent. Raised Printing like Engraving, too. Sold direct from factory only. Write for free catalog of outfits and all details. **KELSEY PRESSES, M-37, Meriden, Conn.**

BRONZE FOUNDRY

Schools and Home Workshops

Make your own castings of aluminum, copper, bronze, silver. Foundry sets are available in three sizes including 2400 Deg. F. blast Furnaces. \$22.50; \$29.50; and \$42.00. f.o.b. Kansas City. Free Circular.

KANSAS CITY SPECIALTIES CO. P. O. Box 6022, Dept. P-3 KANSAS CITY, MO.

ONE ATTACHMENT FREE

with Viking GARDEN TRACTORS

SAVE UP TO \$37.50. Your choice of 6 basic attachments **FREE** if you order your tractor early. **FULL LINE**, 1- and 2-wheel models. All attachments. Latest improved features. Money-back guarantee. Write for catalog.

TERMS AS LOW AS \$10 PER MONTH

American Farm Machinery Co., Dept. M-104
1060 33rd Ave. S. E., Minneapolis, Minn.
43 Church St., Pawtucket, R. I.

DOES EVERYTHING A PIPE-WRENCH WILL DO, AND MORE!

THE AMAZING RATCHETING CHAIN WRENCH



Takes the place of 4 pipe wrenches. Gets into tight places where a pipe wrench cannot be used... capacity $\frac{3}{8}$ " to $4\frac{1}{2}$ ". For jobs around the home, garage or service station.

A must for farmers, steam-fitters, plumbers, electricians.

Grips anything round or hex, in corners or up against a wall.

AT HARDWARE, PLUMBING, AND AUTO SUPPLY DEALERS OR WRITE DEPT. P. M.

Owatonna Tool Co., Owatonna, Minnesota

HOME PAINTING TIP NO. 6

GET CLEAN COLOR SEPARATIONS with the masking tape professional painters use! Apply along desired line, brush on second color and strip off tape as soon as paint "sets". Speeds neat painting of baseboards and door frames, too. Crepe-paper backing conforms to curves. "Scotch" Masking Tape—29¢, 35¢, 89¢—wherever paint is sold.



Say You Saw It in Popular Mechanics

MACMILLAN RING FREE Xtra Heavy Duty is the ONLY motor oil to GUARANTEE:

- to prevent Valves and Hydraulic Lifters from sticking
- to reduce Engine Ping...or Your Money Back!

For further information write: R. S. MACMILLAN, PRES. 530 West 6th St., Los Angeles, Calif.

2 DRILLS in 1

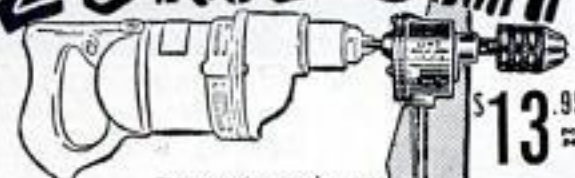

This attachment gives you two drills in one. It converts any $\frac{1}{4}$ inch electric drill to $\frac{1}{2}$ inch capacity. Reduction gears reduce the drill speed 5 to 1, the average speed of a $\frac{1}{2}$ inch drill, and thereby increases the power. Absolutely indispensable for all shop work and home craftsmen.

\$13.95
post paid

Send check or Money Order

Satisfaction guaranteed

Order yours now

G. M. CO. MANUFACTURING, INC.
1308 43rd AVE.
LONG ISLAND CITY 1, NEW YORK

Here's how to Add-A-Room DO-IT-YOURSELF

it's easy with Gold Bond fireproof Gypsum Wallboard



BIG, STURDY PANELS of Gold Bond Gypsum Wallboard cover large areas *fast*, are easily cut to size with saw...or scored with knife and snapped. Apply directly to studs or over old walls.



FINISH OFF all joints with Gold Bond Tape Joint Kit. Gold Bond Wallboard edges are specially tapered for quick application of joint cement and tape...give you smooth, seamless walls.



DECORATE with Gold Bond Velvet, the latex-base paint that "glides on" with roller or brush. Or, you can texture or wallpaper.

Send for *Free* wallboard application instruction folder!



NATIONAL GYPSUM COMPANY
Buffalo 2, New York

MAIL COUPON TODAY!

NATIONAL GYPSUM COMPANY
Dept. PM-34, Buffalo 2, N. Y.

Please send me a free copy of Gypsum Wallboard Application Instruction Folder.

Name.....

Address.....

City..... Zone..... State.....



**STRIP OFF
ANY FINISH
QUICKLY - EASILY**

WONDER-PASTE

For a quick, easy job in removing varnish, paint, enamel, etc., try Wonder-Paste — *it's different*. Applied with a brush, it softens up the finish so it comes off easily — not coat by coat, but in one scraping. Will not run on upright surfaces. Use it on furniture, trim, floors, etc. At paint and hardware stores.

Write for leaflet and advice on your removing problem.

Wilson-Imperial Co., 119 Chestnut St., Newark 5, N. J.



Over 4 million cans sold — it must be good!

"DO IT YOURSELF" FANS!

There's a
CORBIN CABINET LOCK
for every purpose

Put easy-to-install Corbin Cabinet Locks on All your desks, sliding doors, closets, drawers, chests, wardrobes, tool boxes. They make your work easier... make it look better. And they keep valuables secure... keep children away from medicines, guns, etc.

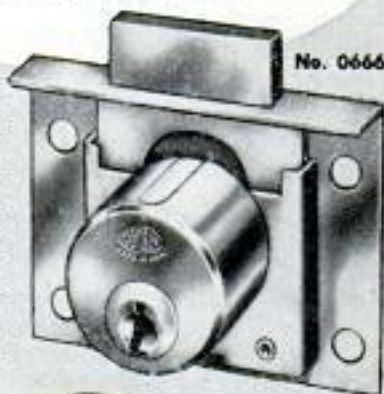

No. 0666

Be sure... with



at leading hardware stores everywhere

CORBIN CABINET LOCK Division

The American Hardware Corporation
New Britain, Connecticut

DO MORE PLANING JOBS WITH LOW COST BELSAW

Exclusive **MONEY-MAKING** features:



- Full 12 1/4 in. x 6 in. capacity
- Power feeds at 24 ft. a minute. (Easily adjusted for lower feed rate)
- Machined cast iron bed; adjustable rolls, total bed length 42 in.
- Provides for Grinding Knives in the Cutterhead.
- Attachments for Jointing, Rabbeting, Tongue, Groove, Matching.

Belsaw Multi-Duty Planer for cabinet shops, builders, lumber yards, woodworking plants and spare time work shops... Now you can convert low cost rough and random size lumber into high priced cabinet finished stock... Easy to make flooring and popular patterns. Belsaw quickly returns cost with savings on raw material... profits on finished stock.

Send Today for **FREE** literature on Belsaw, the **LOW COST, high speed production planer.**

BELSAW MACHINERY CO

1010 Field Bldg. • Kansas City 11, Missouri

**LOW DOWN
PAYMENT
EASY
TERMS**



GOLD - SILVER - URANIUM

GEIGER COUNTERS (as shown) for Uranium Detection. **TREASURE DETECTORS** for gold, silver, etc. Lightweight, ultra sensitive. None finer. Also Mineralights for Tungsten.

• INFORMATION FREE •

Detection corp. Dept. PM-2
5420 Vineland, North Hollywood, Calif



YOURS for less than the cost of a low-priced car.

YOUR OUTBOARD CRUISER David Klein's brand-new, comprehensive, fully illustrated book, guides you in choosing the right hull and motor down to winter storage. \$3.50 a copy at your bookstore or direct from the publisher, **W. W. NORTON & CO., 101 FIFTH AVE., NEW YORK 3, N. Y.**



ELECTRIC EYE

Self generating photo cell—Dia. 1-3/16 inch. This cell turns light directly into electricity—no outside power needed. Make your own Exposure meter—Foot candle light meter, use with a 200 micro-ampere meter. Output as much as 5 ma. in sunlight. Will operate meter type relays directly.

Shipped postpaid with instruction sheet, ONLY \$1.00.
ELECTRONIC PRODUCTS CO., Dept. C, St. Charles, Ill.

SET-UP - KNOCKDOWN SAWHORSE with *Jiffy* BRACKETS



No nails or bolts... use 2x4's for legs. 2x4 or wider for crossbar. Rugged, sturdy, easy to move, saves storage space. Sold by hardware and building material dealers, or order direct.

GRAND HAVEN STAMPED PRODUCTS CO., Grand Haven, Mich.



CUT BUILDING COSTS 2/3!
Make Your Own Concrete **BLOCKS and BRICKS**
To Use or Sell

New superior moulds make absolutely square, true, easy-to-lay blocks which will pass any building code. Production is fast... easy. One durable \$30 machine will make four 5"x8"x12" blocks per minute—1,000 a day. Pays for itself in one day! Sell blocks for big profit... or save 2/3 building cost for yourself. **POST CARD BRINGS FREE FOLDER.**

ECONOMY MFG. CO.
DEPT. P STONE MOUNTAIN, GA.

new type ALUMINUM



MORE strength
LESS weight

ONE PIECE BOTTOM CONSTRUCTION new features eliminate upkeep

Here's the boat you've always wanted. *It's different!* Eliminates upkeep problems... *even painting.* Entirely new design of durable aluminum. Strong, rigid, seaworthy—yet *lightweight!* No leaky, ugly bottom seams. Easy to load, easy to row. Compare feature for feature and you'll choose Starlite.

WRITE FOR FREE 1954 CATALOG

STARCRAFT

Dept. Q-3, Goshen, Ind. **METAL BOATS**

WELD

BRAZE

SOLDER

CUT



4WAY
ONLY
\$14.75
f.o.b. factory

WELDER

Complete with
Twin Carbon Arc
Torch and ac-
cessories... to
handle all metal-
craft work.

Acclaimed by thousands of Homeowners, Mechanics and Hobbyists as the welder of 1001 uses. Easily operated from properly wired 110 volt AC or DC line. The ideal gift with a life-long use... Order today on 10 day money back guarantee.

FOUR-WAY WELDER CO., Dept. F2-C
1810 S. Federal St. • Chicago 16, Ill.

REFLECTO LETTERS GLOW RED AT NITE

Apply to bumpers, rear car windows, lawn signs—anyplace you desire letters easily read when light touches them. Spell your name or warning or catchy phrase. 1 1/2" size. 10c per letter. Minimum order \$1.00. Orders filled day received.

SCIENTIFIC ASSOCIATES, BOX 4334, WASH., D. C.

Take The "PAIN" Out of PAINTING!



Basements . . . Fences . . . Furniture . . .

USE A BECKER CO₂ SPRAY GUN

Take It Anywhere! No Compressor . . .
No Electric Cords Needed. Sprays:
Paints, Oil, Varnishes, Insecticides, etc.

Men! Women! Here's the easy way to lick those tough, tedious, tiresome paint jobs. Becker Spray Gun is fun to use, requires no electricity or compressors—pressurized by low-cost CO₂ cartridges each sprays up to 21 oz. containerful. Used 5 years successfully in industry.

SEE YOUR DEALER! If he cannot supply, order direct for postpd. sht. Extra cartridges 10 for \$1.

SULLIVAN-BECKER CO.
Dept. 114-C Kenosha, Wis.



ONLY
\$19.95
with box of
10 cartridges

NEW!

Giant 1954
148 PAGE
Catalog of

AUTO PARTS

& ACCESSORIES



World's Largest Selection... Everything for
Your Car, Truck, Custom-styled Car, Hot Rod

YOU SAVE UP TO 50%!

50,000 Items . . . all at
WHOLESALE PRICES!

It's ready now... the only complete buying guide to everything you need for your car, truck, custom-styled car, or hot rod... at rock-bottom wholesale prices! Thousands of hard-to-find parts... equipment and replacement parts for cars from 1920 to brand new 1954 models! New Hollywood accessories not offered in stores; High-speed parts to soup up your engine; custom-styling equipment to give your car that "expensive" look. Speedy shipment, guaranteed satisfaction, and money-saving wholesale prices!

FREE if you mail coupon today, we'll send valuable Check Chart that shows you how to know if your car is safe... may save you hundreds of dollars in repair bills... **YOURS FREE** when you mail coupon for Catalog.

MAIL THIS COUPON TODAY!

Get your J. C. Whitney Catalog NOW! Mail coupon with 25c to help pay postage and handling. We'll credit the 25c on your first \$5.00 minimum order, and the Catalog will be **FREE TO YOU!** Mail Coupon TODAY!

J. C. WHITNEY & CO.
1917 P-3 Archer Ave., Chicago 16

Here are just a few
of our 50,000 items



- Auto radios
- Hi-Speed Equipment
- Mufflers, pipes
- Engines, parts
- Transmissions
- Custom-Style Acc.
- Tires, tubes
- Tools
- Springs, shocks
- Ignition parts

J. C. WHITNEY & CO.

1917 P-3 Archer Ave., Chicago 16, Illinois

Rush giant 1954 Catalog of auto parts and accessories at wholesale prices. I enclose 25c to cover part of cost, which will be credited to me on my first \$5.00-or-more order.

Name

Address

City State

FIRST OUTBOARD THAT BAILS YOUR BOAT!



SCOTT-ATWATER brings automatic power bailing to outboarding with *Bail-a-matic*, a built-in feature on 5, 7½, 10, 16 HP models at no extra cost. Free booklet tells the whole story. Address Scott-Atwater Mfg. Co., Minneapolis 13, Minn., Dept. PM-34.

CUT COSTS with ALLEN Punch Press



1-Ton Power Bench Type Powerful, Dependable, Economical

For light work—stamping, framing, riveting — metal, fiber or other material.

Overall height 17½" . . . Base size 8½" x 8½" . . . Die bed 8½" x 8½" . . . Ram face 1½" x 3½" . . . Ram stroke ¾" . . . positive ¾" ram adjustment . . . sturdy, single pin, non-repeat hand lever clutch . . . V-belt drive . . . weight 105 lbs.

\$97.50

The machine of a thousand uses! Adequate for many types of work now done on large presses at greater expense.

30-Day Money-Back Guarantee order TODAY. Price \$97.50 F.O.B. Clinton, Mo. (Includes Motor bracket, V-belt, motor pulley, less motor).

ALVA F. ALLEN, Dept. PM, CLINTON, MO.

READY CUT HOMES

\$2150 AND UP DIRECT FROM MILL

YOU SAVE the items which help make today's building cost expensive: high labor cost, contractor's profit and overhead, insurance, architect's fees. Cut-to-Fit eliminates usual lumber and material waste, also costly mistakes. Anyone can assemble. Simple, easy-to-follow plans furnished and each part numbered. Complete with all lumber, roofing, nails, glass, hardware, paint, doors, windows. Freight paid. Low-cost building plans sold separately if desired. 57 Homes and Floor Plans.



**5 EASY PAY PLANS
COLOR CATALOG**

Send **25c**

INTERNATIONAL MILL & TIMBER CO.
Dept. P.M. 34 Bay City, Mich.

GET THIS Slip-on Coach



in KIT form and assemble yourself. fits all makes of Pick-up Trucks, easy to slip-on or take off. Trailer Kits, Build-it-yourself blueprints for all types of house and camp trailers. Catalog 10c.

COMSTOCK TRAILERS, Dept. K, Parsons, Kansas

NEW PENN YAN BOAT CATALOG

44 PAGES OVER 100 MODELS FREE! Get yours today. Many models illustrated in color. Cartops®, Trailboats, other outboards, canoes, rowboats described fully. Catalog features amazing new no-soak, work-free, all-wood *Striprites*. Penn Yan Boats, Inc., 34th St., Penn Yan, N. Y.

SHEET METAL BRAKES

Angles, flanges, Pittsburgh locks, 24 G. steel, heavier aluminum. Cam locking, mount on bench, truck or floor stand. Truss braced steel. Express collect. 30", 63" lbs., \$28.50, 36", 75 lbs., \$33.00, 48", 100 lbs., \$48.00. Also 8 ft. size. Floor stand, 30 lbs., \$7.00. 15" capacity 16 gauge, 40 lbs., \$21.50.

IRON BENDER forms hooks, angles, eyelets, etc. Capacity 3/4x3, \$9.50. **ADJUSTABLE CLEAT FORMER**, \$2.50.

30" CURVE FORMER, 20 gauge, any diameter, \$9.50. **3 1/2" Wide Pliers**, \$2.00. 1/2" to 3/4" pipe bender, \$5.50.

(Immediate delivery. Order direct, cash or C.O.D., or send for folder)

VYKE BRAKE CO., P-2439 15th St., Denver 11, Colo.

MEMO

Clean the carburetor with **GUMOUT** and **KIT**...

Eliminate hard starting, rough idling, stalling, bucking and high gas consumption caused by a dirty, gummed up carburetor.

It's easy to clean the carburetor on your car with **GUMOUT** and **KIT**. Do it yourself—WITHOUT TAKING THE CARBURETOR OFF THE ENGINE. Engine performance will improve immediately. **GUMOUT** and **KIT** includes a pint of **GUMOUT** and a life-time service kit to feed quick-cleaning **GUMOUT** directly into the carburetor. Sold by leading **AUTO SUPPLY STORES**. If local dealer can't supply you, order direct. **GUMOUT** and **KIT**, complete, \$3.95 post-paid. **GUMOUT** refills, \$1.50 per pint can.

GUMOUT DIVISION
Pennsylvania Refining Company
2671 Lisbon Road, Cleveland 4, Ohio

GIGANTIC MAIL SALE WAR SURPLUS EXCESS INVENTORY BANKRUPT STOCK

Watches—Optical—Precision Units

- Guaranteed — leading makes — tax paid
- Microscope, 3-turret 100-200-300X, \$9.95
- Hand Level, Engineers' Army type, \$2.19
- Transit-Level with tripod and rod, \$77.50
- Altimeter, Car or plane, 0-10,000', \$8.98
- Stop Watch, Precision 1/10 sec., \$12.95
- Wrist Watch, 17 1/2 Executive (\$32.00) \$18.15
- Magnifier, Factory inspection type, \$2.89
- Binoculars, 7x50 Navy type, \$42.95
- Binoculars, 8x25 Finest precision, \$29.75

SUPER CLOSEOUT BARGAINS

- Chain Saw, Gas, leading make, \$199.50
- Chain Saw, Electric, leading make, \$89.25
- Electric Drills, 1/2" AC-DC, 115V, \$26.95
- Air Corps Search Light, 6 volt, \$4.39
- Revolver, Automatic, .22 cal., \$39.95
- Revolver, Sing. shot, .22 cal., \$15.69
- Telephones, City extension type, \$4.89
- Weed Spray Units, 7-row tractor, \$129.50
- Boots, Hunter's—lace to toe, \$9.29
- Tarpaulins, Finest new Army specs, 10-oz. 8x10, \$8.80; 10x12, \$13.20; 12x20, \$26.40

HYDRAULIC BARGAINS

- Save to 80%. Build loaders, diggers, etc.
 - Cylinders, 1-way 3"x8", \$11.95; 2-way, 2"x10", \$22.85; 2-way, 3"x24", \$38.60
 - Pump, 1000 lb. 12-gal. 1800 RPM, \$45.50
 - Pump, 1000 lb. 8-gal. 1500 RPM, \$48.40
 - Valves, Control 1 or 2 way, \$17.95
 - Gauges, 1000, 1500 or 3000 lb., \$3.49
- Many hydraulic items in catalog.

WATER PUMPS & SYSTEMS

- Centrifugals 3/4" \$19.95
 - Rotary, Bronze, rubber paddle, Self priming, Pressure to 30 lbs. 1/2", \$14.75; 3/4", \$19.50; 1", \$25.10; \$32.
 - Auto Water System, Lifts to 22 ft. 110-v 300 gals. per hr. 40 lb. pres. Compact. Easy to install. \$70
- Gauges, valves, couplings, hose, etc. Free advice.

ARMY FIELD PHONE & TEST SET

- Consists of a complete telephone with handset, plus a remarkable test unit that instantly locates faults in equipment, on lines, in power wiring, etc. Using 3 of these sets you talk and signal over 20 mi. of line. In fine carrying case. Gov't. cost over \$150. SALE, F.O.B., \$24.95

BURDEN PAYS ALL SHIPPING CHARGES

REPAIR SHOP TEST METER

- Large 8" genuine Weston precision rugged-type meter and special test leads. Calibrated in ohms. With special test leads. Mount above work bench.
- Ideal for quickly locating trouble in coil condensers, appliances, motors, etc. List \$51.50. SPECIAL, Prepaid, \$12.65

ORCHARD-ESTATE POWER SPRAYER
Special Closeout Carload Of Famous Make!

- Consists of genuine Hydro-Jet pressure pump, 1 1/2 h.p. Clinton engine, 50-gal. steel tank with agitator and 20' hose and hand spray boom.
- The perfect outfit for truck farms, estates, factories, orchards, etc. Used by leading power and phone co's. List over \$200. SALE, \$99.50 F.O.B. Lincoln, or \$108.50 Ppd. A real buy!



AIR TANK

- Large 10"x18" 400-lb. test tank with gauge, hose, tire chuck, nozzle. Fill tires, dust, spray weeds. Cost \$30. SALE...\$14.95 Ppd.

ARMY PARTS CLEANER

- Air-solvent cleaner. Makes dirty, greasy parts shiny bright. Wonderful for garages, factories, farm, repair shops.
- Heavy galv. tank 25"x20"x20". Complete with valve, hose, hydraulic 1st riser. Cost \$100. Ppd. frt. \$29.95

GENERATOR — 3000 -Watt

- DC 115-volt. Fine for chain saws, drills, lights, etc. Ball bearing, compound wound Delco unit. 2800 R.P.M. List \$195. SALE, Prepaid, \$49.50

SUPER SPECIAL!

Carload Sale — 3000-4000 Watt 115-Volt 60-Cycle Plants



- Marvelous new condition Hercules-Hobart units. Gas engine is famous 4-cylinder Z X B Hercules. Generator ball bearing Hobart. Finest instrument panel, controls, etc. Push button start. Weather-proof housing.

• Excellent full time or emergency unit. Generate your own power when disaster strikes. Unit guaranteed new condition, perfect. Buy now while Gov't. surplus is still available. Gov't. cost over \$750. SALE PRICE, \$349.50 Prepaid to you.

POWER PLANTS & GENERATORS

- Plants, 25,000-W, 115-V, 60-C...\$1190
 - Plants, 5,000-W, 115-V, 60-C...\$595
 - Plants, 3,000-W, 115/230-V, 60-C...\$325
 - Plants, 2 to 2.5 KW 115-V, 60-C...\$289
 - Plants, 1,000-W, 115-V, 60-C...\$189
 - Plants, 3,000-W, 115-V, DC...\$189
 - Generators, 3,000-W 115/230-V 60-C \$194
 - Generators, 2,000-W 115-V 60-C...\$139
 - Generators, 1,000-W 115-V 60-C...\$104
- Many other buys in catalog.

AIR COMPRESSOR UNITS

- Paint, clean, for tires, control termite, etc. Build your own or ready built units.
- Deluxe Kit, Tank, compr., gauge, valves, paint gun, regulator, fittings, etc. "How To Build" instructions. \$70 value \$45
- Economy Kit, same, smaller tank, no regtr, paint gun \$32
- Components, Compressors, \$30. Tanks \$5.70. Auto Press, Switch, \$4.95. Gauge (100 lb.) \$1.85. Pop-Off Valve \$1.95. Paint Gun \$9.95. Dust Gun \$1.20.

Many air items, see catalog.

ORDER FROM AD or write for big FREE CATALOG 1000s of items! Motors, sporting goods, hand and electric tools, clothes, clothing, watches, tarps, winches, etc. Write for your copy of Free Catalog today!

Owners of World Famous Nationally Known SURPLUS CENTER
OUR 30-YEAR POLICY : WE PAY ALL SHIPPING CHARGES IN U. S. **BURDEN SALES COMPANY** 817 "O" STREET LINCOLN, NEBRASKA

MAGNETS

- ASSORTED MAGNETS with big list of handy uses.....\$ for \$1
 - POWERFUL POCKET MAGNET ideal for testing metals.....\$1
 - RETRIEVING MAGNET pulls tools, etc., from tank or lake.....\$3
 - HOT PAD MAGNETS to insert in your own hot pads.....\$ for \$1
 - BULLETIN BOARD MAGNETS to "pin-up" memos, etc.....\$ for \$1
 - SLENDER MAGNETS remove chips from drill holes.....\$ 2 for \$1
- WE REFUND EVERY PENNY IF NOT 100% PLEASD... POSTPAID
RONALD EYRICH, 1091 N. 48th St., MILWAUKEE 8, WIS.

"TINY ATOM" ELECTRIC MOTOR BRINGS YOUR MODELS TO LIFE

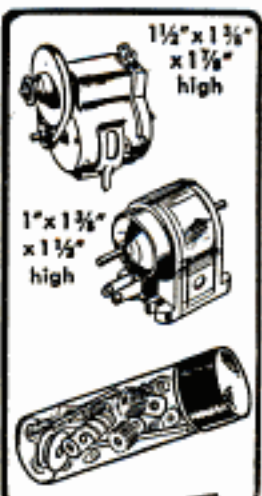

Sold by your local dealer or direct from manufacturer — dependable small motors for dry-cell operation. Suitable for hobby, experiment and use by industry. Thousands used on models, toys, displays. Fully Guaranteed.

- Model 5002—Metal cased, reversible, Alnico-field motor with built-in speed reducer. Pulleys for 4000 and 1000 RPM. Mounting bracket and belt supplied. For 3-4 1/2-6 volts. Price \$3.00
- Model 3100—"Tiny Atom" motor—speeds up to 6000 RPM. Double extended shaft. Permanent Alnico-V magnet field, wound rotor. Heavy duty transparent plastic case. For 1 1/2-3 voltsprice \$2.00
- For higher voltages.....price \$2.50
- Power Accessory Kit K-1300. Vial Contains all parts for applying motor power to models, toys, etc. by belt, direct connection spur gear or worm drive.....Price \$1.00

Remit with order and see pay postage in U.S.A. No C.O.D. Add 3% Sales Tax for delivery in Ohio. Write Dept. PM.

For quick delivery see your local dealer — or order direct



WILSON'S OF CLEVELAND
425 Lakeside Ave., N.W. • Cleveland 13, Ohio

SOIL PREPARATION and CULTIVATING MADE Easy



WRITE FOR ILLUSTRATED BROCHURE
Dept. B GEORGE GARDEN TOOLS • SULLIVAN, ILL.

Life Insurance FOR Wood



**Stops Rot
Kills Termites
Controls Warping
and Swelling**

★ DO IT YOURSELF

Brush, spray or dip-on Seal-Treat before painting wood. Clear, non-staining, water-repellent. Acts like a prime-coat . . . just paint over it. For wood not to be painted use general-purpose Deep-Treat.

Ready-to-use in handy 1 and 5 gallon cans, or 55 gallon drums. At your Lumber, Hardware or Paint Dealer.

FREE! "ABC's of Wood Preservation"

CHAPMAN CHEMICAL COMPANY
DERMON BUILDING • MEMPHIS, TENN.

CHAPMAN *Clean* PENTA WOOD PRESERVATIVES

CUT PERFECT GROOVES WITH *Warren* WASHERS ON YOUR SAW BLADE!

You Just *DIAL*
the Cut Wanted
over 250,000
sets in use!

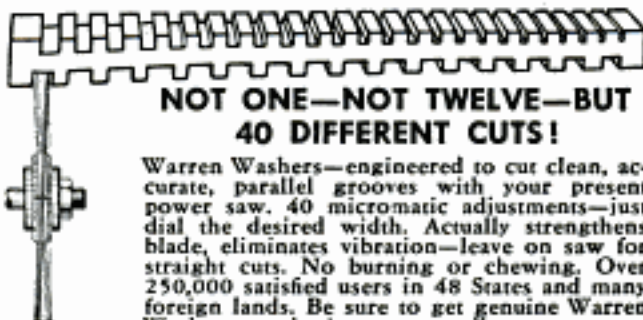

**NOT ONE—NOT TWELVE—BUT
40 DIFFERENT CUTS!**

Warren Washers—engineered to cut clean, accurate, parallel grooves with your present power saw. 40 micromatic adjustments—just dial the desired width. Actually strengthens blade, eliminates vibration—leave on saw for straight cuts. No burning or chewing. Over 250,000 satisfied users in 48 States and many foreign lands. Be sure to get genuine Warren Washers . . . they're guaranteed!

FREE! Send for free descriptive booklet. Arbor sizes 1/2", 3/8", 3/4", 1". See your dealer or write direct.

WARREN WASHERS CO.

Dept. 23, Box 98, North End Station, Detroit, Mich.

**ONLY
\$4.95
SET**

Get Our Big Manual of "HARD-TO-GET" ITEMS

For home craftsmen, wood workers, industrial art departments, furniture repair men, hobbyists, cabinet makers, etc. Send only 50c today for your copy.

A few of the items we sell: Inlays, fancy cabinet wood, lumber, Ebony, Holly, Dimension cut lumber, lignum vitae, Carving Blocks, Turning Squares, 120 kinds of veneers. Abrasive papers, archery woods, bill-board clamps, binswings, bed fasteners, blueprints. Chair braces, brass chain, brass fencing. Craftsmen books, candlestick holders, candlestick sockets, card table hardware, casters. Chair case, ceramic tiles, clamp nails, crib hardware, Dorels and dowel pins, dowel centers, drawer rollers, felt. Flock finishes, foam rubber, furniture clamps, complete professional finishing materials. Folding tablelegs, hand tools, furniture pulls, modern and period, chest and ornamental hardware, all types of hinges and locks, small box hardware, Inlaid picture kits, Inlaid card table tops, leather working tools, Micarta, revolving Lazy Susans, musical instruments, moulded wood carvings. Metalcraft material, Mogo Sander, nut bowl hardware. Picture frame moldings, Pre Cut Wood Fix, perforated steel panels, plaster standards, plastics and plexiglass, internal carving bits, plastic polishing compounds. Electric routers, sanders, foot rheostats, hand drills, sprayers, revolving fixtures for television tables, chairs, etc. Fibre rush, screw hole buttons, spiral saw blades, sliding door track, sharpening stones, home owners specialties, 100 woods, ski woods, platinum rocker springs, Table leaf supports, tack rags, thermometer cards, turned furniture legs, typewriter fixtures. Complete upholstery supplies, Veneer presses, wood burning pens, wood working instructions, black and copper wrought iron hardware, sizzler wire.

Send fifty cents today (refunded on 1st order) for your copy of the Country's leading Catalog, "Constantine Manual for Craftsmen" to:
ALBERT CONSTANTINE & SON, Inc.
Dept. PM-21 797 East 135th St. New York 54, New York

HOBBYISTS! SHOPMEN! *Special* ONLY \$54.50

PALMGREN "HOBB-E" Rotary, Index, Milling Table

Ideal for Model Parts or Shop Work

Mill-Grind-Drill-Index-Route curved or straight-Rabbit and Mortise on drill press or lathe. 8" Table, 4" Cross Feed, 360° Rotation, Accurately Graduated. Bolts to table. Order NOW! SAVE \$100. Only \$54.50. Less Rotary Feed \$39.75. Write for "HOBB-E" Tool Circular.

CHICAGO TOOL AND ENGINEERING CO.
8365 South Chicago Ave. Chicago 17, Ill.



POWER HACKSAW \$55.75

LESS MOTOR
F.O.B. Benton Harbor



Send for full details and name of nearest dealer.

EXCEL MACHINE TOOLS Dept. PM-34 BENTON HARBOR, MICHIGAN

• Rugged cast iron construction. Wt. 56 lbs. bronze bearings. Draw cut. Auto. return lift. Auto. shut-off. Vise swivels 45°. Cap. 4"x4".

THE BEST IN PLIERS? **CHAN NEL LOCK**

CHAMPION DeARMENT TOOL CO., MEADVILLE, PA.

TREASURE -- \$10,000

New locator detects metals, valuable minerals and buried treasure. Money-back guarantee of superiority.



Also price counters. Govt. reward of \$10,000 for uranium discovery. Write for FREE information.



THE GOLDAK COMPANY
1542 W. GLENDAYS BLVD., GLENDALE, CALIF.

TV PICTURE INTERFERENCE

"Vid-tronic" TV WAVE TRAP stops PICTURE interference instantly. No more annoying wavy lines, jumping pictures, streaks, etc. caused by autos, appliances, power lines. Easy! Attaches to set in 30 seconds.



\$2.98
Add 25c P.P. & Ship.

TUBE WHOLESALERS CO.
BOX 364, DEPT. PM-5
ROCKVILLE CENTRE, N. Y.

STOP INSTANTLY

RADIO and TV NOISES

New electronic design "Bell-tronic" line filter eliminates NOISES caused by all motors, appliances, autos, oil burners, etc. Simply plug radio or TV cord into filter & filter into wall socket.

\$1.00 Add 25c P.P. & Ship.



No C.O.D. — Try 5 Days Money Back Guarantee
SPECIAL OFFER \$4.00 For Both P.P. & Ship.
Don't Accept Inferior Imitations

LASTING PROTECTION



DURABLE PLASTIC FINISH

GUARANTEED NOT TO CRACK, CHIP OR PEEL!

"How it Lasts!" say boat owners who use BoatLIFE Durable Plastic Finish. Beautiful glossy BoatLIFE, tested for years under the most severe weather and water conditions has been found to be the toughest, most flexible, finest finish your boat can have. BoatLIFE is WATERPROOF, amazingly flexible and elastic. Resistant to marine growth . . . protects against rot.

So Easy To Apply! Flows on smoothly, even over other finishes. Brushes tack free in dampest weather. Use on wood, metal or canvas. On metal, use primer first. BoatLIFE outlasts and is superior to the finest spar varnish!

Whether you choose glistening Plasticlear, or any of BoatLIFE's brilliant colors, Blue, Red, Green, Gray, Black, Ivory, and non-yellowing Flat or Gloss White, you'll be delighted with its smooth glossy surface. Ask for BoatLIFE at your dealer. Or order direct. THINNER FREE with each can. \$3.85 qt., \$12.80 gal., postpaid. West of Mississippi add 25c qt. or 90c gal., to cover shipping costs.

WRITE TODAY FOR FREE FOLDER WITH COLOR SAMPLES
Boat Builders! Send 10c for folder "How to Select the Right Boat Lumber." Helpful for construction and repairs.

M. L. CONDON CO., INC. (Est. 1912)
Specialists in Marine Finishes and Boat Lumber
266 Ferris Avenue White Plains, N. Y.

Say You Saw It in Popular Mechanics

EVER GET CROSS AT CROSSROADS?



A HULL AUTO COMPASS eliminates lost tempers as well as lost directions . . . takes the puzzle out of which way to turn wherever you drive. Only Hull offers choice of two mounting brackets for IDEAL means of installation in ANY car. Write for local dealers name, free literature.

MORE HULLS IN USE THAN ALL OTHERS COMBINED.

HULL MFG. CO. P.O. Box 246, D3 WARREN, OHIO

Beaconite 16 1/2
Screaming 14 1/2

SUMP PUMPS 2,400 GALLON CAPACITY

1 1/4" outlet - No screen to clog - fool proof

The time tested Lokomona sump pump is absolutely automatic - has a special fool-proof trap at the intake - oilless bearing at the bottom. Made of aluminum castings, it's 4 1/2" high and carries a 1/4 H.P. 100 V. A.C. heavy duty motor. The pump is designed for continuous service. Enclosed switch. All parts always available. Order yours today. C.O.D. If cash with order, we pay freight.

MONEY BACK GUARANTEE
LOKOMONA PUMP CO., P.O. BOX 86, ROYAL OAK 1, MICH.

\$46.50 COMPLETE

\$28.00 LESS MOTOR

\$24.50 PUMP ONLY

PAGE Garden Tractors
1954 line now ready - low prices!

Ruggedly built riding and walking models, 2 to 6 HP All gear drive with reverse, no belts or chains. Plow, till, harrow, disc spray, remove snow, do dozens of other farm and home chores. Also new "Bantam" one-wheel model.

Fully Guaranteed
Low prices - easy terms

Free Catalog Shows over 60 attachments!

PAGE does every job faster - cheaper!

PAGE 1904 S. 81st Street MILWAUKEE, WISC.



USG DURON*

the hardboard of 1001 uses



You can build it yourself easier, faster—and the job comes out *right* with DURON because *this* hardboard is made for easy sawing, bending, nailing, laminating, drilling. Smooth on both sides, responds well to edge treatment—the finished job actually *looks professional*. You needn't paint the rich brown surface of DURON—but if you want to, it takes paint beautifully! Try this practical hardboard in your home workshop!



TOOL CHEST



DOG BED



CLOTHES HAMPER



MAGAZINE RACK

FREE PLAN BOOK

12 pages of easy-to-follow plans for making useful things. Ask your dealer or write Dept. PM-3, 300 W. Adams, Chicago 6.



*U. S. Pat. Reg. U.S. Pat. Off.

UNITED STATES GYPSUM

The Greatest Name in Building

Good News FOR HOME BUILDERS!

Save 30% to 40%

Don't pay several hundred dollars more than necessary when you build a home! Buy direct from our mill at our low, factory, freight-paid price. We ship you the lumber cut-to-fit, ready to erect. Paint, glass, hardware, nails, etc., all included in the price. Plans furnished — also complete building instructions. No wonder our customers write us that we saved them 30% to 40%. Architecturally approved construction. (Not pre-fabricated.)

LEWIS MANUFACTURING CO.

1243 LAFAYETTE AVE.

BAY CITY, MICH.



\$3243

Handsome Big Catalogue

Pictures wonderful homes in colors at money-saving prices. Designs to suit everyone. Send 25c for catalogue today.

BIG BOOK of House Plans in Colors 25¢

The SPEEDY STITCHER

Sews quick and strong, making new or repairing all sorts of leather and canvas articles — boots, shoes, coats, gloves, belts, saddles, golf bags, Ski, Football, Baseball, Skating, Hunting, Fishing, Camping bags, grain bags, burlap, etc.



Each stitcher comes ready to use with a reel of waxed thread and 3 needles, assorted sizes. Needles are carried in handle. A handy tool for home or on hunting, fishing or camping trips. Price Postage prepaid \$1.00. **LYMAN BRADFORD CO.** Box No. 201 KINGSTON, MASS.

BE YOUR OWN BOSS!

Make Up to \$50 Daily As a Floor Surfacing Contractor

BE INDEPENDENT! You can be free of bosses and layoffs and earn as high as \$50 a day sanding floors with Clarke equipment. A small investment will start you off in the growing building field. Get ready now for good pay and a big future. Start the way hundreds of successful contractors have by mailing this coupon today.



CLARKE SANDING MACHINE CO.

453 Clay Avenue Muskegon, Mich.

I'm interested! Send me complete free details on how to be a floor surfacing contractor.

NAME _____

STREET _____

CITY _____

STATE _____

Thousands in Use

SMALL! POWERFUL!

America's finest low cost tractor. Ruggedly built. Easy to operate. No belts, no chains. Borg-Warner clutch, trans. and diff. 140 to 1 reduction, 40% more drawbar pull than ordinary tractors. 5-1/4 H.P. engine—gasoline or kerosene. 20 quick change implements. Write for complete details.

ENGINEERING PRODUCTS CO.
915-K-3 Niagara Ct.
Waukesha, Wis.

ECONOMY TRACTOR

RADIO CONTROL YOUR MODELS

"DELUXE MIDGET 1" Radio Control consists of license free TRANSMITTING & RECEIVING Radio plus a control ESCAPEMENT. Long range to operate Aircraft, Boat & Auto Models. Three units above easy assembly with our parts and plans. \$9.98

DETAILED INFORMATION & RADIO CATALOGUE 25c

Special "SUPPLY DIRECTORY" plus a \$7.00 Supply Coupon. . . \$1.00

Book "RADIO CONTROL OF MODEL AIRCRAFT" \$2.98

"DELUXE MIDGET 1" RADIO CONTROL \$9.98

RADIO MODELS, BOX 36, DEPT. PM, BALTIMORE 6, MARYLAND

STARRETT "Tools and Rules" BOOK

Describes and illustrates the precision methods skilled mechanics use. Only one dime. Write Dept. AP.

THE L. S. STARRETT CO., Athol, Mass., U. S. A.

SUPER DRILL GRINDER

Sharpens round shank drills from 3/32" to 1/2" in diameter, up to 6" long. Grinds old drills like new in 4 different point angles, using hand or power grinding wheels. Money-back guarantee. . . only \$2.95

At Dealers or Postpaid

A. D. McBURNEY Dept. A-39
5908 Hollywood Blvd. Hollywood 28, Calif.

MAKE UP TO \$5 AN HOUR WITH

EASISHARP

Big profits in your spare time sharpening scissors. We show you how to start making money immediately. This is your chance now to have your own business with Easisharp. Sharpen a pair of scissors in less than two minutes! A child can operate it. Weighs only 10 lbs. Every home, barber, tailor, dressmaker — everybody uses scissors and all need sharpening two to four times a year. Don't let some one else get ahead of you. Write immediately to

SERR-EDGE MACHINE CO., 9731 Lorain Ave., Cleveland, Ohio

MONEY MAKING PLAN FREE

Handy wall bracket holds 4 screwdrivers — neat, convenient, attach to wall, cabinet or bench in a minute! Only 19¢ at hardware stores where you see Bridgeport Tools.

NEW

Screwdriver
HANDY RACK

FREE!

Bridgeport
TOOLS

when you buy any three Bridgeport screwdrivers at your hardware store.

Bridgeport Hdwe. Mfg. Corp.
Bridgeport, Conn.

ONE-MAN SAWMILL LOW \$50⁰⁰ AS... 50⁰⁰ DOWN

Take BELSAW Portable Sawmill right to the trees—turn out valuable lumber for home and farm—sell to local yards—make up to \$50 a day custom sawing for neighbors. BELSAW lasts a lifetime. No crew needed. Power with tractor or auto engine. Beginners get excellent results. Send today for FREE BOOK, "HOW TO MAKE LUMBER".

BELSAW MACHINERY CO.
P.O. #118 Field Bldg. Kansas City 11, Missouri

BATTERIES! — START

—a factory at home and re-cast junk batteries into new; latest achievement. We supply complete instructions and everything needed. Large daily profits!

BATTERY LABORATORIES, Dept. PM, Minneapolis 4, Minn.

Find HIDDEN TREASURES

GEIGER COUNTERS (as shown) for Uranium Detection. TREASURE DETECTORS for gold, silver, etc. Lightweight, ultra sensitive. None finer. Also Mineralights for Tungsten.

• INFORMATION FREE •

Detector Co. Dept. PM-4
5420 Vineland, North Hollywood, Calif

ACCURATE TACHOMETER and Vibration Indicator

Amazing new slide rule that finds vibrations per minute, checks r.p.m. even when no moving parts are exposed. Keep high speed machines, outboard motors, grinders, rotary lawn mowers, model airplane engines etc. operating at proper speed. Quick, simple, accurate, pocket-size. Tune up your motors the scientific way.

satisfaction guaranteed!

ONLY \$5⁰⁰ PREPAID

MARTIN Engineering Company
70 Rose street, Kewanee, Illinois

FREE Pocket Carrying Case
Vibra - Tak complete with leather case — \$5.00. Send your name and address.



This oil-pumper needs Tough-but-oh-so-gentle piston rings*

Oil pumping is just the start of expense and trouble—the first danger signal from worn-out piston rings. The longer you let those old rings stay in, the more oil you'll use, the more power you'll lose, and the bigger your repair bill will be!

As your engine gets older, it runs hotter because of accumulations in the cooling system. The cylinders wear tapered and out-of-round—need more oil on the walls.

It requires a special type of piston rings—replacement rings—to deliver this extra oil, under full control, without waste.

Hastings makes replacement rings exclusively, devotes all its research on the highways and in the laboratory, to the particular replacement problems of each make and type of engine.

That's why Hastings Rings stop oil-pumping, check cylinder wear, restore engine performance—in re-ring, re-bore and re-sleeve installations.

So go to your motor specialist at the first sign of oil-pumping or performance drop-off. If rings are the trouble, ask him to install a Hastings Steel-Vent replacement set. Truly the best money you can spend on your car! Hastings Manufacturing Company, Hastings, Michigan; Hastings Ltd., Toronto; Piston Rings, Spark Plugs, Oil Filters, Casite, Drout.

HASTINGS
STEEL-VENT PISTON RINGS
Regular or Chrome

TOUGH on Oil-Pumping
GENTLE on Cylinder walls

New Gadget Dispenses "Instant" Shave Lather!

Now science declares "push-button" war on whiskers! Here's shaving lather right out of a can . . . the richest, creamiest lather you ever saw. Ready instantly!

No brush to slow you down . . . no greasy cream to clog your razor. Just push valve and out comes lather! That's AERO SHAVE . . . greatest shaving invention in 50 years. AERO SHAVE wilts toughest whiskers fast, thanks to 3 wonderful beard-softeners. It also contains soothing Lanolin for extra skin comfort, freedom from shaving irritation.

Enjoy quicker, slicker shaves every day with AERO SHAVE lather bomb . . . only 59¢.

Not 89¢... Not 69¢ only 59¢

Use "Push-Button" Lather

AERO SHAVE



Also economical King Size—12 oz. only 98¢

The New Model 70 UTILITY TESTER FOR REPAIRING ALL ELECTRICAL APPLIANCES MOTORS • AUTOMOBILES • TRUCKS

As an electrical trouble shooter the Model 70:

- Measures A.C. and D.C. Volts, A.C. and D.C. Current, Resistances, Leakage, etc.
- Will measure current consumption while the appliance under test is in operation.
- Incorporates a sensitive direct-reading resistance range which will measure all resistances commonly used in electrical appliances, motors, etc.
- Leakage detecting circuit will indicate continuity from zero ohms to 5 megohms (5,000,000 ohms).
- Will test toasters, irons, Broilers, Heating Pads, Clocks, Fans, Vacuum Cleaners, Refrigerators, Lamps, Fluorescents, Fans, Switches, Thermostats, etc.
- Will test all TV tubes for open filaments, inter-element shorts, burned out tubes, etc.

As an Automotive Tester the Model 70 will test:

- Both 6 Volt and 12 Volt Storage Batteries • Generators • Starters • Distributors • Ignition Coils • Regulators • Relays • Circuit Breakers • Cigarette Lighters • Stop Lights • Condensers • Directional Signal Systems • All Lamps and Bulbs • Fuses • Heating Systems • Horns • Also will locate gear grounds, breaks in wiring, poor connections, etc.

Handsome re-enclosed molded bakelite case, 3 1/2" x 5 1/2" x 2 1/2". Complete with all new leads. Also included is a 64 page book giving detailed instructions for testing all electrical appliances, automotive equipment, TV tubes, etc. Only \$15.95

SHIPPED ON APPROVAL NO MONEY WITH ORDER—NO C. O. D.

Try it for 10 days before you buy. If completely satisfied then send \$3.95 and pay balance at rate of \$4.00 per month for 3 months — **NO INTEREST or SERVICE CHARGES** added. If not completely satisfied, return to us, no explanation necessary.

W068 ELECTRONIC DIST. CO.
Dist. D-14, 2848 Tenth Ave., New York 24, N. Y.

Please rush 1 dollar to 1 agree to pay \$3.95 within 10 days after receipt and \$4.00 per month thereafter

Name _____
Address _____
City _____ State _____

**PICTURED PERFECTION—
BULLDOG
TRAILER PARKING JACKS!**



MODEL 50-P makes hitching or parking trailers an easy, one-man job. Rides flush. Easily installed. \$15.37 complete, postpaid (when paid in advance).

Manufacturers of a complete line of Safety-Engineered trailer parts. Write for Brochure 13-C

HAMMER BLOW TOOL COMPANY
"As old as the Industry"
WAUSAU, WISCONSIN

**NEW! EXCITING!
JET EXHAUST CUT-OUT**



Now your car can sound off those exciting, dynamic tones — easily controlled mechanically from your dashboard. Channel your exhaust through special pipes or muffler without removing your original muffler. Easily installed. **MONEY BACK GUARANTEE.**

• **MADE OF HEAVY PLATE STEEL**
• **UNIVERSAL—FITS ALL EXHAUSTS**

Send \$1.95 (postpaid) check, cash, money order (add \$1.00 for postage outside of U.S.A.) to:
Fur Sales, Dept. PM3, 1840 S. Michigan Ave., Chicago 16, Ill.
Dealer Inquiries Invited

**STRATEX DRAFTING FURNITURE
FITS TIGHT BUDGETS!**



It costs less to buy the best when you buy direct! Guaranteed Stratex equipment fits any wallet, any space, any requirement — lovely to look at too! Free data.

STRATEX INSTRUMENT CO., INC.
1861 F HILLHURST, LOS ANGELES 27, CALIF.

**TRANSFORMER \$19.95 FOR
WELDER QUINCY**



Complete with everything. Ready to plug in. 110 volts AC. 15-30 Amps. 3 heats. Welds metal from 1/16" to 1/4" using 1/16" to 3/32" standard rods. Guaranteed unconditionally. 10-day trial. No C.O.D. Does everything welders costing up to \$75.00 do. Buy direct and save.

ESSAY MFG. CO., INC., Dept. 25, Quincy 69, Mass.

Say You Saw It in Popular Mechanics

2 OR 4 WHEEL DRIVE FOR JEEPS IN SECONDS

AMAZING NEW WARN HUB



gives your 4-wheel drive Willys 2-wheel pep, power, speed, extra mileage, passenger car performance—as well as 4-wheel power and traction! Change from 2-wheel to 4-wheel or back in seconds by turning fingertip control on hubs. Warn hubs reduce wear on front axle assembly and front tires, eliminate shimmy, increase gas mileage up to 6 miles per gal. Unconditional Money Back guarantee. \$65.00 pair prepaid. **ALSO AVAILABLE:** Warn Standard Hub for Willys \$20.00 pr., Dodge \$23.00 pr. and Warn Automatic Hub for Willys \$120.00 pr. At Dealers or direct.

WARN MFG. CO., RIVERTON Box 6064-A2, Seattle 88, Wash.

41 NEW MODELS for 1954

Custom-Craft

THE ORIGINAL "PACKAGED"
BOAT KITS

RATED "TOPS" BY THE EXPERTS in
DESIGN, STYLING, PERFORMANCE

See the World's finest, most complete line
before you decide! 41 exciting new models.

SEND 25c for BIG, NEW
1954 KIT CATALOG

1954 Catalog PLUS booklet "Boat
Selection, Operation & Maintenance"
\$1.00. (Refundable)

DEALER INQUIRIES INVITED



Modern **BOAT PLANS**

*World's
Finest
Designs*

With FULL-SIZE PAPER PATTERNS
EASIER TO BUILD, SAVES TIME, MONEY

Over 150 modern plans and patterns with material
lists and building procedure. Racing classes,
cruisers, inboards, outboards,
sailboats, 6 to 36 ft. All materials,
fittings, etc. available
at "Package" prices. Big savings!
Design Catalog tells all!

SEND 35¢ for 1954 DESIGN CATALOG

Design Catalog PLUS boat building handbook, \$1.00

CUSTOM-CRAFT • DEPT. 7 • BUFFALO 7, N. Y.



**MAKE YOUR OWN FOUNTAINS, LAKES,
RIVERS, WINDOW DISPLAYS**

With New *Miniature Water Pump*
Here's real action for window displays,
Xmas tree layouts, or the home lab. Pump
only 4 3/4" high—3 1/4" wide. Threaded for
pipe, or uses 3/8" rubber tubing. 110 A.C.
60 Cycle. 1/250 H.P. 50 gals. per hr.
Furnished complete—ready to work—your
satisfaction absolutely guaranteed
or your money back. **\$9.95**
MOORE MANUFACTURING COMPANY
Swedesboro 15, N. J.

FREE CRAFT CATALOG



120 PAGES... Craft Supplies,
Tools, Designs, Instruction
Books from America's Largest,
Most Complete Handcraft
Stock.

Send for your free copy NOW!

GRIFFIN CRAFT SUPPLIES

5626-A Telegraph Ave • Oakland 9, Calif.

SLIDE RULES

Guaranteed Accurate Slide Rules
Regularly Sell for \$4.00 and Up

World's most useful tool for fast, easy calculating.
Multiplying, proportions, division, roots. Full 10-
inch A, B, C, D, C1, and K Scales. "Clearsite" hair-
line indicator with metal frame. Ideal for

- Bookkeepers
- Salesmen
- Farmers
- Mechanics
- Students
- Draftsmen
- Housewives
- Armed Forces
- Everyone

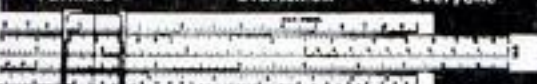

FREE Complete instructions on how
to get correct answers instantly
without pencil or paper

98¢
postpaid

SLIDE RULE MAN, Dept. 102-B
2031 Shore Blvd., Astoria, L. I., N. Y.

Shopmaster **SAVE \$25.00 on**
SPECIAL FOR
HARDWARE WEEK

PLUG IN

**Floor Model
TILTING
ARBOR
SAW**

Including Attached **1/2 HORSEPOWER
MOTOR**

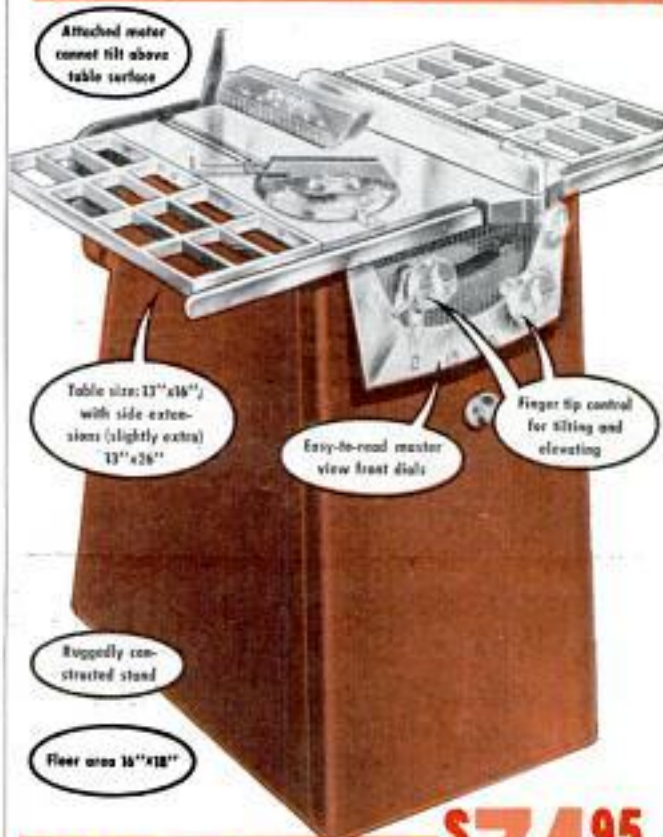

Attached motor
cannot tilt above
table surface

Table size: 13"x16"
with side exten-
sions (slightly extra)
13"x26"

Easy-to-read master
view front dials

Finger tip control
for tilting and
elevating

Ruggedly con-
structed stand

Floor area 16"x18"

\$99.95 Value Specially Priced at

\$74⁹⁵

A \$25.00 Saving During Hardware Week, April 16-24



**JUST
PLUG
IT IN!**

SHOPMASTER scores again! First with a ready-
to-use . . . ready to plug in Floor Model Tilting
Arbor Saw. It's ideal for your home shop. Take it
home . . . plug it in . . . and start sawing.

It's a precision tool, simple enough for even the
beginner, yet accurate and efficient enough for
the professional hobbyist.

Every feature of the new SHOPMASTER Floor
Model Tilting Arbor Saw is designed for easier
operation. Attractive, easy to read master view controls provide
unusual accuracy, eliminates guesswork. Novel transparent plastic
guard gives 100% visibility for precision cutting. Cuts up to 2 1/2", tilts
to 45° has 1/2" arbor. Sealed for life ball bearings. Special motor
mounting provides easy rail adjustment even when motor is at 45°.
1/2 H.P. 1725 standard speed attached motor is included in price.

MAIL COUPON FOR FREE CATALOG

SHOPMASTER, INC. Rm. 101
1214 South 3rd St., Minneapolis, Minn.

Please send me a free catalog.

Name _____
Address _____
City _____ State _____

Now You Can Do It Yourself



CONFINE DESTRUCTIVE
COOKING HEAT,
GREASE and STEAM
TO YOUR STOVE

It's the Most Important
Protection You Can Give Your
Expensive Decorations and Furnishings!

Anyone who can use a keyhole saw, hammer and screw-driver can easily install a Vent-A-Hood. Work a miracle in your home! The cooking odors you smell drifting throughout your home are hot, buoyant animal fats or vegetable oils cooling and settling to become a rancid, ruinous film on woodwork, walls and furnishings. Vent-A-Hood consumes Summer's stifling cooking heat and Winter's steamy, greasy cooking vapors before they can touch your home... providing real home comfort and saving money year after year. Vent-A-Hood traps cabbage odors which wall or ceiling fans cannot. Vent-A-Hood is complete with simple-to-follow step-by-step instructions.

Write Today! Money Back Guarantee!
Write for free Cooking Ventilation
Folder, order blank and Vent-A-
Hood's detailed, no risk, money back
guarantee.



Vent-A-Hood

1901 PLANTATION ROAD DALLAS, TEXAS

HOME COOKING VENTILATION SPECIALISTS

Make up to \$50 Per Day

—with a
SPREAD-EASY
Cement
and Tape
Applicator



Tapes Wallboard Seams 4 Times Faster!

Now anyone can do a workmanlike job of applying cement and tape to dry wall construction seams in one fast, easy operation. Spread-Easy Applicator was developed by a well-known decorating contractor. Hundreds in use. Trouble-free operation.

Comes complete with fittings for inside and outside vertical corners, vertical wall seams and horizontal ceiling seams. Satisfaction guaranteed. Order today!

\$2650
each
postpaid

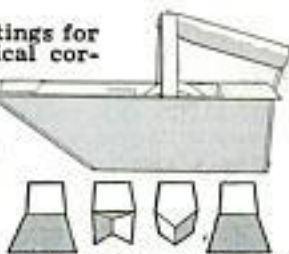

Write Department 10

DEBS DECORATORS OLD MIDDLETON ROAD
MADISON 5, WISCONSIN



QUALITY UNSURPASSED—
PERFORMANCE UNEQUALLED
Yet Cost No More Than
Ordinary Screwdrivers!

HOLD-E-ZEE

The Original AUTOMATIC GRIP
SCREWDRIVERS

*Much Wanted
Special Features*



EXCLUSIVE
**LOK-
BLOK**

Makes Blade
Twist & Impact
Proof

AT ALL
LEADING
DEALERS

USPON BROS., INC., ROCHESTER 14, N.Y.

PLYWOOD BOAT KITS

(Freight Included) 12 FT. \$9700
14 FT. \$12900



Build these
12 or 14-ft. sport
runabouts from readycut
parts. Kits include all hardware,
etc., to complete the boat shown. Send for free folders
of all models as low as \$32.00 freight included.

TAFT MARINE WOODCRAFT

Dept. J, 636 39th Ave., N. E., Minneapolis 21, Minn.



Treasure - Minerals - COINS

Easily located with new Light-
weight M-Scope Detector. Su-
perior performance, lowest
price, monthly payment plan.

FREE LITERATURE
FISHER RESEARCH LAB., INC.
PALO ALTO CALIF.

SEND ONLY \$1 for next 6 issues of famous DELTA-GRAM, best home woodworking magazine you ever saw. Packed with shop-tested ideas—12 to 15 in each issue. Send \$1 (no stamps) to: Delta Power Tool Division, Rockwell Mfg. Co., 502C N. Lexington Ave., Pittsburgh 8, Pa.



Assemble
Your Own **DIVING LUNG**
We furnish the parts and instructions.
Complete outfits \$39.95 and \$49.95
Write for descriptive literature.

Assemble Your Own Portable
EMERGENCY OXYGEN OUTFIT

Complete parts and instructions furnished. Outfits from
as low as \$9.50 up to \$59.50. Write for literature.

• Air & Oxygen Tank. For Diving Lung, etc. 295 cu. in.
capacity. 1800 psi. Hydro. tested, current dating, ICC-
3A1800. Reconditioned. Wt. 12 3/4 lb. F.O.B. St. L. \$40.99

Ed. Aguado Trdg. Co., Dept. B, Box 4525 Plaza Sta., St. Louis, Mo.

**FREE
Catalog!**

Underwater
swimming
equipment.
Write today!

A MICHIGAN PROPELLER MATCHED TO YOUR OUTBOARD MOTOR, BOAT AND LOAD

WILL PROVIDE BETTER
PERFORMANCE

FOR RACING OR PLEASURE

Write for FREE 1954 catalog. Con-
tains much helpful boating
data and carefully engineered propeller
recommendations.

MICHIGAN WHEEL CO., Dept. P-83
GRAND RAPIDS 3, MICHIGAN



STOP CHANGING MOTOR OIL!

End this needless expense forever with

RECLAIMO Today's most advanced OIL RE-REFINING filter FOR CARS, TRUCKS, TRACTORS.

Continuously cleans and RE-REFINES motor oil as you drive by utilizing motor heat — keeps oil in high grade lubricating condition at all times.

"RECLAIMO"

- REMOVES SOLIDS (by filtration)
- REMOVES WATER (by distillation)
- PREVENTS Excess fuel dilution
- PREVENTS Acid and Sludge Formation
- ADDS Thousands of Miles to Engine Life

MAINTAINS Stable Viscosity **ELIMINATES** All Oil Changes
FREE 32-page book "OIL FACTS" with bonafide \$1,000.00 offer on page 30. Give you the complete "Reclaimo" story and details of our extraordinary 90-DAY NO-RISK TRIAL OFFER. Write for your copy today!

RECLEAN FILTER CO.

5083 Elston Ave., Dept. M-3, Chicago 30, Ill.
 Wm. Schwaige, U.S. Pat. 1757223, 1834654, 2008473.

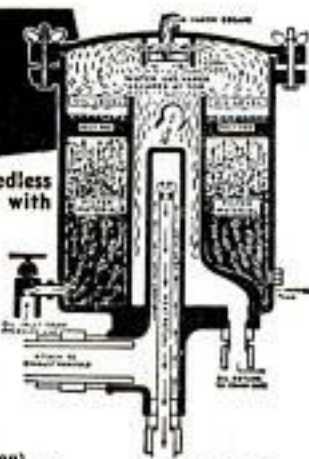

DEALERS WANTED

U. S. BUREAU OF STANDARDS, Bul. 86 States, "Oil does not wear out mechanically."

Only \$97¹⁵ Buys a SKIL "Do-It-Yourself" Shop

... the perfect combination of portable and stationary tools!



1. Portable Saw

SKIL Home Shop
 6" Saw—Model 516
Only \$43.95

2. Bench Saw

3. Drum Sander

4. Shaper and Groover

SKIL Saw Table—\$33.95 SKIL Sander-Shaper Kit—\$19.25

You have the world's finest portable saw for remodeling your home, cutting plywood panels, sheeting, siding. You can even cut stone, metals or compositions with special blades.

You have an unbeatable bench saw combination to do precision sawing plus the shaping and sanding necessary in building cabinets and furniture.

You get fast, easy cuts because of SKIL plus power. Make quick, simple bevel or depth adjustments. You marvel at the ease of handling.

No other saws at anywhere near the price have all these features!

- Oversize Motor • Ball and Anti-friction Bearings
- Built-in Bevel and Depth Adjustment
- Telescopic Safety Guard • Trigger-type Switch
- Sturdy Die Cast Aluminum Housing



A SKIL Saw Combination is ideal for the precision cutting needed in making cabinets.



A SKIL Saw is so easy to use, so accurate a beginner can make furniture with professional results!



Whatever your project, pay only for materials and build it with a SKIL combination!

SKIL Home Shop and Builder's Saws available in 6"—7 1/4"—8 1/4" blade sizes. 22 SKIL Home Shop Tools. Visit your hardware dealer, appliance or dept. store.

SKIL

HOME SHOP TOOLS

Made only by SKIL Corporation, formerly SKILSAW, Inc.
 5033 Elston Avenue, Chicago 30, Illinois; 3601 Dundas Street West, Toronto 9, Ontario
 Factory Branches in All Leading Cities

Make Money SELLING Eshelman Tractors and doing GARDEN WORK



ESHELMAN ROTARY TILLER

ONLY \$99.95 Turns virgin ground into a garden bed in one operation. Replaces plowing, discing, and cultivating. Women can operate it. Also 1 to 8 H.P. POWER MOWERS & RIDING TRACTORS from \$69. Free Catalog. Write:

ESHELMAN CO., Dept. T-53
 119 Light St., Balto. 2, Md.
 333 N. Michigan Ave., Chicago-1, Ill.
 7070 H'wood Blvd., Los Angeles 28, Cal.

BUILD YOUR OWN ARC-WELDER

We show you how to build NEW powerful welder. No rewinding. Uses most any surplus aircraft generator. Easy to build. 75-300 amps. Complete PLANS 25c. Send today and we'll include FREE our Big War Surplus & Electrical Catalog.



LEJAY MFG. CO., 1247 LEJAY BLDG., MINNEAPOLIS 8, MINN.

LOW PRICED TURNTABLES

for radios, TV converters, lazy susans, many other home, office, shop uses. Standard model's rigid 16 gauge steel plate, 12" x 8", rotates with 3/4" clearance on patented no-oil bearing, holds up to 50 lbs.



Agents, Dealers write for terms. Mfrs. write for other sizes.

Mail Check or M.O. to FURBLO CO., Hermansville 1, Mich.



Here now for 1954

A beauty to see... a breeze to move... a bargain to own! The HOWARD all-steel insulated mobile home, time-tested from Alaska to Florida, now better by a lifetime of living improvements! For details write: HOWARD Industries, Box 2188—Dept. 21—Saginaw, Mich.

Howard COACH

HOWARD INDUSTRIES INC., SAGINAW, MICHIGAN

PIONEER WORK SAVERS
NOW BETTER THAN EVER—GREAT NEW 1954

SHAW
"DU-ALL"

Garden and Small Farm Tractors

Plow.. Cultivate.. Mow.. Rake.. Bulldoze..
Saw Wood.. Make Many Other Hard Jobs Easy



Sturdy 1½ to 5 H.P. Walking Tractor
Best for all around garden and lawn work. Variable speeds, adjustable wheel widths, individual gang tool controls. 3 speed and reverse automotive gears on 3 and 5 H.P. models. Superb traction, deep plowing, easy handling. All wanted tools and attachments.

Rugged, Low Cost 2½, 5, 8 H.P. Streamliner
Powerful, practical, streamlined, comfortable. Pulls 8, 10, 12 inch plows, cultivator between 38" rows, bulldozes, mows lawns, operates belt attachments. 3 speeds and reverse automotive transmission. Friction brakes. ¾ to 7 M.P.H. Nothing else like it in a tractor that will get the work done.



Inexpensive New Tiller... Lawn Mower
Nine inch rotor pulverizes 12 inch swath 6 inches deep. 1½ H.P. Extremely low cost. Rotor quickly replaced with single wheel for lawn mowing, hauling, etc.

Also larger 3, 12 H.P. riding tractors with 3 speeds and reverse automotive gears.



See the SHAW Dealer Write direct for FREE CATALOG complete Shaw line.

SHAW MANUFACTURING CO.
4503 Front St., Galesburg, Kansas
668-G N. 4th St., Columbus, Ohio

**More work... less effort with a
DESMOND-SIMPLEX VISE**



Extra features... no extra cost

The Desmond-Simplex Utility Vise is the handyman's "third hand"—for easier, faster work—for sure results, smooth finish. At no extra price, Desmond has extra features: steel slide, enclosed screw, shoulder-fit jaw inserts, pipe jaws (replaceable on larger models), cut-off tool, anvil with horn, 360° swivel, non-pinching type handle. Ask your hardware retailer for a Desmond-Simplex Utility Vise. Write for folder showing vise applications in home, garage, or farm shop.

The Desmond-Stephan Mfg. Co.
Walnut Street, Urbana, Ohio

Wagemaker's
WOLVERINE BOATS

OBC

"Wolverine" rates highest with boating enthusiasts who know. Feel the faster speed, sure control that "Wolverine" superior designing offers. Seaworthy and easy to keep up. From Literature.

WAGEMAKER CO.
Grand Rapids, Michigan
Dept. 54

Window Paint Roller
Keeps Paint Off Glass!

Now paint your window sash easily, quickly, neatly—with the clever new Window Paint Roller. Just fill paint reservoir and roll paint on sash right up to the glass smoothly, cleanly, without getting any paint on the glass. Dozens of other uses—for stripping, outlining, paneling, etc. Use indoors or out. Order Today!

Only \$1.00

MAIL ORDER NOW. Pay postman only \$1.00 plus C.O.D. and postage. Or send \$1.00 plus 10c for postage and handling. Money Back Guarantee. Send your order today!

STRADER PRODUCTS, Dept. C-178, 259 Strader, Cincinnati 26, Ohio



Start a NEW BUSINESS!

or Add to your present Repair Business
SHARPEN DULL PIPE WRENCHES
PIPE TAPS & DIES
"GUM" CIRCULAR SAWS
Also MOTOR DRIVEN ROTARY HONE
Write for Information

J. C. MOORE INDUSTRIES
BOX # 276 FREDONIA, PA.



TOOLMAKERS & MACHINISTS

New magnetic spacing blocks make the job easier. Blocks are highly magnetized and polarized on one side only. Picture shows how the blocks space work out in a chuck. Use these blocks on face plates, millbeds, grinders, surface plates, etc. Send \$2.00 for set of 4 blocks. Prices and information sheet on other blocks sent with first order. Postpaid in U.S.A.

VENCO MANUFACTURING CO.
102 Lyndhurst Sidney, Ohio

Say You Saw It in Popular Mechanics

JOB LOT TRADING 53 Vesey St. NYC

COMBINATION STETHOSCOPE

SURPLUS—NEVER USED
High Chrome Finish



\$2.95 Postpaid
REGULARLY \$12.00

A professional instrument for detecting delicate mechanism defects.

No C.O.D.'s. Send Check or Money Order to Dept. PM 5

ace
of
Aces
in
**LOW
COST**



Up to
75
miles
per
gallon

transportation

Cushman is the top card in the transportation deck for speed, power—low cost operation. Ride it to work, for sport, school, on errands, deliveries. You're set to go! No traffic or parking worries either. And total operating cost **LESS THAN A PENNY A MILE!** See your nearest Cushman dealer for **FREE** demonstration.



CUSHMAN MOTOR WORKS, INC.

917 No. 21st St., Lincoln, Nebraska

\$12⁹⁵
F.O.B.
complete

**WELD
BRAZE, CUT
SOLDER**



PAYS FOR ITSELF!

The most practical time and money saving welding outfit. Genuine craftsman's unit — easy to operate. Ideal for auto repairs, farmers, tin-smiths, hobbyists, etc. Plug into any properly wired 110 volt A.C. or D.C. line. Follow simple instructions to weld on Iron, Steel, Aluminum, Bronze, Brass, and other metals. Order today!

**10 DAY
TRIAL
ORDER
NOW**

ALL-WAY ARC WELDER, Dept. PM-3
6 Short Street Mt. Vernon, N. Y.

**U-BUILD IT • FIREPLACE
AQUARIUM**

MONEY MAKING HOBBY

Can be built around any standard hearth. Beautifies. Colorful. Recirculating water. Tropical fish. Growing plants. Also lights up.

Inexpensive and easy to build.

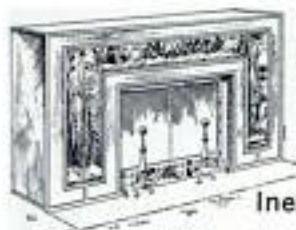

Entirely New and Unusual
SPECIAL COPYRIGHT PLANS \$2 PPD. NO COD.

A. J. BERNA COMPANY

20160 SHERWOOD

DETROIT 34, MICH.

Save \$89.50

on this **PORTER-
CABLE**
combination!

STARTS

as a **ROUTER**



Router Complete with
base and motor—\$49.50

BECOMES

a **PLANE**



By adding Plane At-
tachment — \$25.00

THEN

a **SHAPER**



By adding a Shaper
Table — \$29.75

Interchangeable Motor
powers 3 tools . . .
saves cost of 2 motors!

All 3 Tools for only \$104.25

For expert woodworking, build your home workshop around this Porter-Cable Tool combination—production tools used by Builders—and save \$89.50!

As a ROUTER—you can tongue, groove, rabbet, dovetail, do scrollwork, cut contours and beaded edges on wood, composition or plastic.

As a PLANE—you can shave off wood at high speed—taking cuts from $\frac{1}{64}$ " to $\frac{3}{32}$ " deep—without a wave or ripple! Attachment for sharpening right on the job.

As a SHAPER—you can edge irregular pieces; joint strips accurately, even narrow and short pieces; make hundreds of fancy cuts for cabinets, furniture, trim, toys, picture framing, molding, etc.

Purchased separately, all tools complete with motors would cost you \$193.75. But, with one Interchangeable Motor mounted in the proper attachments, you get all 3 tools for only \$104.25 — a saving of \$89.50!

See this great money-saving combination at your Porter-Cable dealer's. Or mail coupon.

Porter-Cable

Quality Electric Tools

PORTER-CABLE Machine Co.

2443 N. Salina St., Syracuse 8, N. Y.

Send me full information about Porter-Cable Router, Plane and Shaper Combination . . . also name of nearest Porter-Cable dealer.

Name

Address

City State

Manufacturers of SPEEDMATIC and GUILD Electric Tools
In Canada write: Strongridge, Ltd., London, Ont.

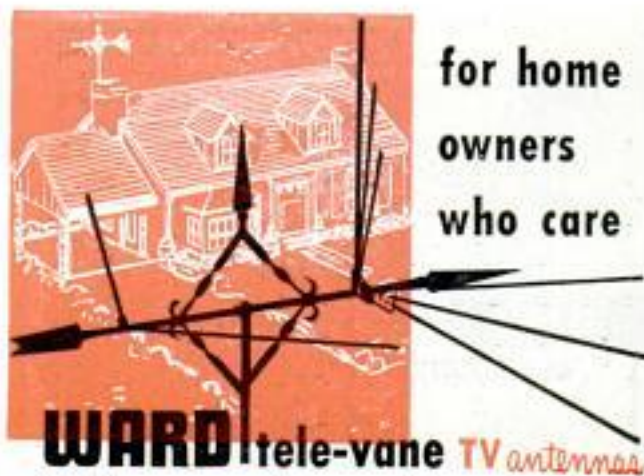

WARD Tele-vane TV antennas

Add beauty to your housetop with a smart modern Ward Tele-vane Antenna . . . and also be assured of peak reception. . . Insist on Ward Tele-vane antennas for your new or replacement installations.

Contact your local TV dealer or service man today about Ward Tele-vanes. Use the coupon below to send for a free descriptive folder.

THE **WARD** PRODUCTS CORP. division of the **GABRIEL** Co.
1148 EUCLID AVE., CLEVELAND, OHIO

The Ward Products Corp., Div. The GABRIEL Co., Dept. PM 354, 1148 Euclid Ave. Cleveland 15, Ohio

Send me free folder describing the complete line of Ward Tele-vane TV-Antennas.

Name _____
Address _____
City _____ State _____



NEW 1954

Do-It-Yourself LUMBER CATALOG



FEATURING AMERICA'S FINEST FURNITURE AND CABINET LUMBER FOR THE HOME SHOP CRAFTSMAN

Now you can buy your "Do-It-Yourself" Lumber in small quantity orders of \$20 or more. Send for new 32-page, net price catalog which contains detailed information on 16 species of Furniture Lumber, Plywood, Dowels, Turning Squares, etc., as used by the home craftsman.

● For complete catalog, send 15c to cover handling and mailing costs. Mimeographed Price List sent free.

HARDWOOD CORPORATION OF AMERICA

E. L. DIVISION
Box 1091, Dept. M
Asheville, N. C.

I enclose 15c for "Do-It-Yourself" lumber catalog.

Name _____
Address _____
City _____ Zone _____ State _____

JOINT AND SHARPEN ALL SAWS

SAVE TIME AND \$\$\$



Sensational new Super Filer joints and sharpens both hand and circular saws 6" to 10" with all teeth the correct height, depth, pitch and bevel. Easy to use—when file hits hardened steel roller, teeth are finished. Saw runs true and smooth with no side pull. Complete with special 8" file \$9.95 ppd. **FREE FOLDER.**

"TRU-CIRCLE" saw set. Automatically sets teeth at 10° or more \$2.95.

FILE SAWS THE RIGHT WAY



SO EASY with this new filing jig and jointer anyone can now sharpen any hand saw like new! When file hits hardened steel rollers teeth are finished and EXACTLY THE SAME HEIGHT. All teeth cut and saw runs true and smooth. Jig and instructions \$2.95 postpaid. Free Folder. A. D. McBURNEY, 5908 Hollywood Blvd., Hollywood 28, Calif., Dept. A-39

AT ALL HARDWARE STORES

FULLER'S famous "FOUR-IN-ONE" Screwdriver

- No. 2 Recessed for cross head screws;
- 1/16" Diameter for fine work;
- 3/16" for electrical work;
- 1/4" Diameter for regular work;
- heavy aluminum chuck.

UNBREAKABLE HANDLE
HI-CARBON STEEL!

ONLY \$1 set

FULLER TOOL CO., Inc. 3522 Webster Ave., N. Y. 67

Export Sales Dept., John H. Graham Co., 105 Duane St. • New York, U. S. A.



I WILL SAVE YOU UP TO 90%

Send for my NEW 48 pg. illustrated BOOK OF BIG BARGAINS for mechanics, farmers, gadgeteers, outdoorsmen. Prices unbelievably low. Send dime today.

KARL ORT, Dept. PM, York, Pa.

WAR SURPLUS
BARGAIN BOOK 10¢

Motor coupling included



DRAINS cellars, laundry tubs; **FILLS** tanks; **CIRCULATES** oil; **IRRIGATES** gardens, fields.

1,001 USES—HOUSE, GARDEN, FARM

Original "Type P" All-Purpose Pump has 2400 GPH capacity. 360 GPH 75" high, or 1800 GPH from 25" well. Use any 1/2 to 1/2 HP motor. Oil-less bearing. 1" inlet; 3/4" outlet.

STAINLESS STEEL SHAFT. DOES NOT CLOG!

Only \$6.95. Postpaid if cash with order. (West of Miss. add 50c) Money Back Guarantee. Also Gear Pumps in all sizes.

LABAWCO PUMPS \$6.95
BELLE MEAD 2, N. J.

HELPFUL BOOKS

Send post card asking for FREE catalog
Popular Mechanics Press, 200 E. Ontario, Dept. 601, Chicago 11

Regular Price of a Slide Rule \$4 and up



Slide Rule

92c
and this coupon
Add 8c Postage

If you can use a pencil you can use a slide rule
For bookkeepers, accountants, salesmen (figuring commissions, cost, etc.), farmers, housewives, etc. For Armed Forces highly important. Men's most useful tool. Easy to calculate instantly. Multiplying, proportions, divisions, roots, etc. "High Vision" Clear View Slide. Full 10" Rule. A, B, C, D, C1 and K scales. **FREE** 28-page instruction book on how to get correct answers instantly without pencil or paper.

Gene Loewy, 545 5th Ave., Dept. 43-M, N.Y. 17
Limit three rules to each coupon

ROTOMATIC "Self Propelled" ROTARY TILLER

High in VALUE
Low in PRICE

Send for
NATIONAL'S
'54 Catalog H
filled with
Super Values

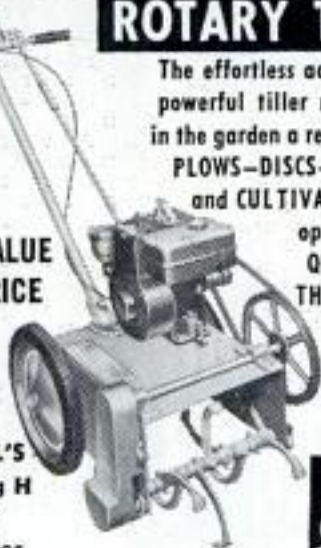

The effortless action of this powerful tiller makes work in the garden a real pleasure. PLOWS—DISCS—HARROWS and CULTIVATES in one operation . . . QUICKLY and THOROUGHLY.

ONLY
9950

- EASY STARTING 2 H.P. BRIGGS ENGINE
- FINGER TIP THROTTLE CONTROL
- UNBREAKABLE MALLEABLE STEEL TINES
- SEMI-PNEUMATIC RUBBER WHEELS

NATIONAL FARM EQUIPMENT CO., INC.
142 GREENE STREET • NEW YORK 12, N. Y.

SURPLUS SALE!

HIGH SPEED
ROTARY FILES
MADE OF
HARDENED HIGH SPEED STEEL

Regular price \$13.45. For plaster, steel, brass and aluminum working. Guaranteed. (All other sizes available.) Order by check, money order or C.O.D.
PULASKI METAL PRODUCTS CO., INC.
Pulaski, N.Y.

\$5.99 for all 6
Sizes: 1/4, 1/2, 3/8, 5/16 and 3/2
All 1/4 inch shanks

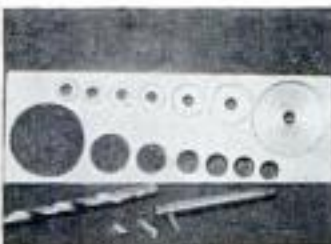

DRILL PRESS USERS

Add the capacity to machine KING SIZE BOLTS . . . from a dime to a dollar . . . with simple tools. Attach a MECK SPEED SELECTOR. This compound drive is now available for all 14" to 16" drill presses. **\$2450**

MECK MFG. CO., Dept. M
547 W. Lake St., Chicago 6, Ill.

TOOLS AT FACTORY PRICES

Save up to half on Fully Guaranteed New Tools

6 pt. 12 pt.

8 PRICE DEEP SOCKET SET
3/4" Drive, 6 pt. or 12 pt. sizes 3/4" to 1 1/2" in Metal Box **\$4.00**
Be sure to specify whether you want 6 pt. or 12 pt.

MATCHED SETS

3/4" Drive: 12 sockets, 3/16" to 1 1/2"; T-handle, flexhandle, 2 extensions, steel box **\$5.00**

3/8" Drive: 8 sockets, 3/8" to 3/4"; reversible ratchet, flexhandle, speeder, universal joint, 4 extensions, steel box **\$12.00**

1/2" Drive: 11 sockets, 3/8" to 1"; reversible ratchet, flexhandle, speeder, universal joint, extension, steel box **\$15.00**

3/4" Drive: 16 sockets, 3/8" to 2"; reversible ratchet, flexhandle, T-bar, 2 extensions, steel box **\$40.00**

56-page catalog free with order, or send 10c for catalog only
Send money-order, check or currency to —

MECHANICS TOOL CLUB 5319 HORTON STREET
OAKLAND 8, CALIF.

EXTRA! EXTRA!

**MOST
DO-IT-YOURSELF
SANDING IS
*VERTICAL!**



No. 504
\$19.95
in Fiber Case

Best!

The light, powerful Syncro "504" is your best buy, dollar for dollar, in the sander market. Remember—most home sanding is vertical (see pictures at right). The Syncro reciprocating motor is absolutely guaranteed against burn-out during your ownership or replaced Free. Exclusive Double Arc Motion assures satin-smooth finish. Ideal for polishing, too. Free from twisting torque. At dealers or post-paid.



* PANNELLING
DOORS, FRAMES



* WINDOW
FRAMES



* CABINETS



* DRY WALL
CONSTRUCTION



No. 504-D in
METAL CASE
\$22.95



VERTICAL
SANDING

No More Heavy
Muscle-tiring
"Weight-Lifting"
with My light,
torque-free
4 pound Syncro

SYNCRIO SANDERS

SYNCRIO CORPORATION, DEPT. D-34, OXFORD, MICHIGAN

- ORDER: I enclose \$_____ Send No. 504 Sander postpaid (on 10 Day Money Back Trial).
- With Metal Case, Accessories, \$22.95.
- In Fiber Case, Accessories, \$19.95.
- FREE CIRCULAR: Send for Free "HOW TO SAND" Booklet and Circular.

Name _____
St. & No. _____
City _____ State _____

Enjoy New Driving Comfort with the Sensational



PNEUMATIC SPRING BOOSTER



Front AIR LIFTS are specifically designed to give you new driving comfort. They dampen the suspensions, cushion the bumps and eliminate costly repairs.

You'll appreciate the ease with which you can drive the roughest roads and the severest turns with AIR LIFTS to steady your car.

For comfort, stability and safety install AIR LIFTS in your FRONT coil springs. To assist your rear springs . . . if you are carrying overloads . . . use REAR AIR LIFTS. Installation is simple . . . nothing to dismantle . . . economical and guaranteed.



See Your Dealer Today or Write to:

AIR LIFT CO.
2330 W. Main Street
LANSING, MICHIGAN



The easy way to paint!

Speedy Sprayer



Favorite of home owners and craftsmen for 20 years! SPEEDY SPRAYER gives your work that professional paint finish everyone admires. Sprays paint, enamel, varnish, lacquer, etc. . . . 4 to 7 times faster than hand brushing! Lightweight, portable, uses any 1/4 H.P. motor. Improved diaphragm principle assures clean, oil-free air. You'll find dozens of time and money saving uses for SPEEDY SPRAYER, including spraying insecticides 2-4-D and DDT. Complete outfit, without motor, only \$36.50.

At leading hardware, lumber, and auto supply dealers. FREE—write for handy booklet "How to Spray."

W. R. BROWN CORPORATION
2635 N. Normandy • Chicago 35, Ill.

ONLY
\$36.50
LESS
MOTOR



How to save money on all plumbing jobs — using approved methods.



How to select materials and fixtures.

Save on Plumbing Costs

When You Build · When
Making Improvements
Repairs · Maintenance

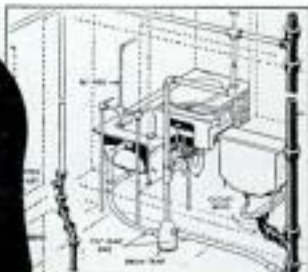

How to plan and lay out plumbing installations.

15 Ways to Save Money in Your Own Home

All about modern home plumbing

How to use plumbing tools in your home

Getting acquainted with pipe

Pointers on planning home plumbing systems

Installing and maintaining the home drainage system

Your own private sewage disposal system

The causes of drainage troubles and how to cure them

Home water lines and how to install them

Valves and faucets and what to do with them for best and most economical service

Your own private water supply system

All about water heaters and automatic supply

Methods and advantages of water conditioning

Water system troubles and how to prevent and cure them

How to install plumbing fixtures and take care of them for longer life

Do All Kinds of Jobs Yourself With Home Plumbing Guide

Got a leaky faucet; a clogged drain; a noisy hammering water pipe? Want to add a bathroom to your home, install a new kitchen, or even build a home? Then you need Popular Mechanics' HOME PLUMBING GUIDE. It shows how you can do every kind of plumbing job yourself and can easily save you hundreds of dollars. Savings on even a small job will pay for this practical book many times over. It covers plans and layouts, installation, maintenance and repair of all home plumbing systems; tells you what materials to get and use and how to do a proper job with approved methods.

Over 500 Pictures and Diagrams and Hundreds of Money-Making Tips

Simple everyday jobs, bigger remodeling and improvement jobs and complete installations are made clear and simple and easy to follow. Few, other than the simplest tools are required and some of these can be rented. Pipe, materials and fixtures are available from mail order houses, hardware dealers and supply houses. Don't pay high prices for work you can do yourself. Get the HOME PLUMBING GUIDE. You will be amazed how the practical text and hundreds of how-to-do-it pictures simplify jobs you thought might be difficult.

Mail Coupon. Money Back if You Want It

Get the HOME PLUMBING GUIDE today. Only \$3.50. Read it. Study it. Put the vital information it contains into practice. Then if you are not satisfied return the book for a complete refund of your money. Order today.



Mail Coupon Today for Money Back Home Trial

POPULAR MECHANICS PRESS, Dept. HPG-1
200 East Ontario Street, Chicago 11, Ill.

Send Popular Mechanics HOME PLUMBING GUIDE in cloth binding at once. I understand I may return the book in 7 days for full refund of my money.

Remittance for \$3.50 enclosed. Send postpaid.

Send C.O.D. (U.S.A. only) I will pay postman plus charges.

Name _____

Address _____

City _____ Zone _____ State _____

NEW! Every Electric Drill A Powerful PORTABLE JIG SAW

"ARCO JIG-SAW"

HAS SAME CAPACITY,
CUTS AS FAST AS SAWS
COSTING \$50 & UP!

DOES THE WORK OF
ALL THESE SAWS: JIG,
KEYHOLE, COPING, RIP,
CROSSCUT, BAND,
HACKSAW.

HAS EXCLUSIVE, BUILT-
IN AUTOMATIC AIR
BLOWER.



At
Better
Hardware
Stores
Everywhere

Pat. Pend. 
No. 500
"ARCO JIG-SAW"
\$10.95
complete with blade.

Here for the first time any-
where is a Portable Jig Saw
that attaches in ONE MINUTE to any 1/4" electric
drill. "ARCO JIG-SAW" will handle any project from
the smallest to the largest. In minutes it cuts intricate patterns,
circles, etc. in plywood, wallboard, plastics, metals—even cuts
lumber up to 2x4's! It cuts openings for plumbing, switchboxes,
etc. without boring a starting hole. Built-in AUTOMATIC
BLOWER keeps cutting line free of sawdust.

"ARCO JIG-SAW" is a powerful, lightweight tool that is easy to
handle because of its Right Angle Drive. Strong Safety-Yoke &
Worm Drive Clamp make it a vibration-free unit. Extra large
Shoe-Plate assures accurate and square cuts. Blades are changed
in seconds with screwdriver. Converts to Table Model with
No. 401 "ARCO STAND"—Sturdy Casting. \$2.75
No. 505—Six extra Blades for wood, metals, etc. \$1.95

90-DAY FACTORY GUARANTEE
BUY THE BEST—see your hardware dealer now! If not available,
try "ARCO JIG-SAW" on our 10-DAY MONEY
DEALERS—
write for
nearest jobber.
BACK GUARANTEE. Send us check or M.O.
(Postpaid). C.O.D.'s—postage extra.

ARROW METAL PRODUCTS CO.

Dept. PM-3, 140 WEST BROADWAY, NEW YORK 13, N. Y.

HELPFUL BOOKS

Send post card asking for FREE catalog

Popular Mechanics Press, 200 E. Ontario, Dept. 601, Chicago 11

FREE Plan To Build Your Own Self-Propelled POWER MOWER



Now you can save money by building
your own Power Mower. Pulls itself—
Steers itself. We furnish you any part
or parts you need plus building instructions.
Write for FREE PLANS
. . . No Obligation.

T & H Mfg. Co., Dept. P-3
811 E. 31 St., Kansas City, Mo.

FREE

How to repair broken windows



Repair broken windows
yourself. Learn how. Free
Picture book tells all.
Write for free copy while
limited printing lasts.

MAIL THIS HANDY COUPON RIGHT AWAY

Red Devil Tools, Irvington 11, N. J.
Please send Free copy of Booklet HT-906

NAME _____
ADDRESS _____
CITY _____ STATE _____

Make BIG Money Arc Welding Anywhere!

with
this

"Husky Boy" 200 ampere gas drive Arc Welder

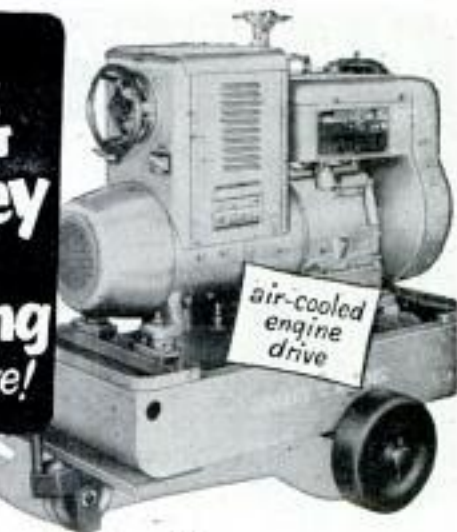

air-cooled
engine
drive



200 Ampere
Bantam Champ



Generator
for "Building
Your Own"



Transformer
Type AC Welder

Cash in on those profitable emergency repair
jobs with the lightweight, easily portable,
"Husky Boy" arc welder. For in or out of
shop welding you get years of dependable
service at a low investment cost. Wheels
and handles available at slight extra cost.

"BANTAM CHAMP"

Specially built for smaller shops requiring
lighter weight and lower investment, the
"Bantam Champ" gives full 200 amp.
capacity. With this generator, you can build
a portable arc welder with very little cost.

AC WELDER AC POWER

Building your own with the AC Welder and
AC Power Unit lets you do numerous repair
jobs where no power is available . . . also
furnishes emergency power for electric lights
and power tools. 200 or 300 amp. size plus
5KW AC power.

AC TRANSFORMER TYPE

Here's a real welder for production and re-
pair work in shops that want improved alter-
nating current welding performance.
Operates on single phase 220 volt power
lines.

HOBART BROTHERS CO., BOX M-34, TROY, OHIO
Phone 21223 "One of the world's largest
builders of arc welding equipment"

Enroll Today in the HOBART SCHOOL of WELDING

You can learn
welding quickly and easily in this modern
non-profit school. Complete or partial course.
Best equipment, thorough training, experi-
enced instructors.

G. I. Bill Approved
Check Coupon for
Free Booklet!



Complete operator's
training course. 200
pages fully illustrated.
Lessons Book \$1.00

Hobart Brothers Co., Box M-34, Troy, Ohio

Please send data on items checked: Welder's Vest
 "Husky Boy" "Bantam Champ" Pocket Guide
 AC Welder AC Power AC Trans- (Free)
 former Type Hobart Trade School
 Lessons Book, \$1.00

NAME _____
ADDRESS _____
CITY _____ STATE _____

New "PULL-GEAR" SPEED-REDUCING PULLEY



Provides Correct Speed and Power to Drill Up to 1 3/8" with 1/2 H.P. Motor

Amazing new internally geared speed reducer doubles drill press capacity. Greater power, greater efficiency, greater productivity.

Provides the correct speed and power for larger drilling, reaming, tapping and boring on light presses. Easily installed in five minutes. Adaptable to all type machines. Spindle speed range approx. 45 to 3000 RPM. Made in 3 motor shaft sizes: 1/2" - 5/8" - 3/4". Write for literature.

WRITE FOR LITERATURE

THE PULL-GEAR CO.

25427 Mound Road
Centerline, Mich.

THE MIGHTY MIDGET



GUARANTEED
WORLDWIDE RECEPTION
ON 3 SHORTWAVE BANDS!
PLUS STANDARD BROADCAST

Without any special aerial, you can pull in Radio Moscow, London, Paris, Berlin, South Africa — ships at sea, aircraft, police — plus standard broadcast with new power and clarity! By the makers of U. S. Navy receivers. Hear this sensational radio value! **\$59.95**

Also hear "The World Master". Compares favorably with shortwave receivers selling for \$300 and up!
Only \$129.95!

Write for complete details and name of nearest National dealer.

National
EST. 1914
61 SHERMAN ST. MALDEN, MASS.

make this table yourself!
"IN YOUR OWN SHOP!"



FOR AS LOW AS \$12.95

HERE'S WHAT YOU GET with Du-It-Yourself kits:

- Professional design • Fine mahogany and oak woods • Quality hardware • Pre-cut or "roughed-out" kits • Complete blueprints • All materials • A furniture series • Lifetime 10% discount.

NEW! EASY! LOW COST!

DO-IT-URSELF KIT



PROFESSIONAL QUALITY—LOW COST Now! Build furniture with Habig's Du-It-Yourself kits! It's fun! Kits come pre-machined (ready for assembly) or "roughed-out" (ready to machine and finish). It's the hobby idea of the year . . . and you'll take pride in the furniture you make in your own shop. Send for information! Order today!

JOIN THE CRAFTSMASTERS! GET A LIFETIME 10% DISCOUNT ON ALL KITS! Order any kit before Mar. 31—become a Craftsman and get a 10% discount on kits for life! Limited offer—hurry!

FREE! WALL SHELF



MONEY-BACK GUARANTEE! WRITE FOR FREE INFORMATION

HABIG MFG. CO.

with any 3 kits you order!

P. O. 187 • JASPER, IND.

MONEY for MEN ALL DATA FREE

THE PLASTEX Industry needs manufacturers on small scale and for big production of Lamp and Clock Stands, Art Goods and Novelties in Plastex and Marble imitation. Experience unnecessary. 1/2c material makes regular 10c store sellers. Small investment brings good returns. We are now placing big Chain Store Orders with manufacturers. Ambitious men have chance for real prosperity. Our Free booklet will interest and benefit you.

PLASTEX INDUSTRIES, Dept. A
3400 Third Ave. New York 26, N. Y.

Say You Saw It in Popular Mechanics



Build it Yourself!

TRAILER COACHES

Complete Trailer Book and Construction Data for 10, 16 and 22 Foot Trailers — Only \$1.50

Here's everything you want to know about trailers, with plenty of pictures and plans and instructions for building three different types. Covers also, history of trailers, trailer parks, camps and overnight-stops information, furniture, furnishings, materials and engineering data. If you want to build a trailer, live in a trailer, or just want to know more about trailers, get this book. Only \$1.50 postpaid. Rush order to:

Partial Contents

Trailer Parks—Living in a Trailer—Towing a Trailer—Floor Plans—Service—Classifications—Balance—Dollies—Jacks—Weight Distribution—Construction—Working Drawings for a Two-Place, Standard Travel and Standard Dwelling Trailers. Size 8 1/2 x 11 1/4 inches.

POPULAR MECHANICS PRESS • Dept. 350, 200 E. Ontario St., Chicago



REMODELING'S EASY

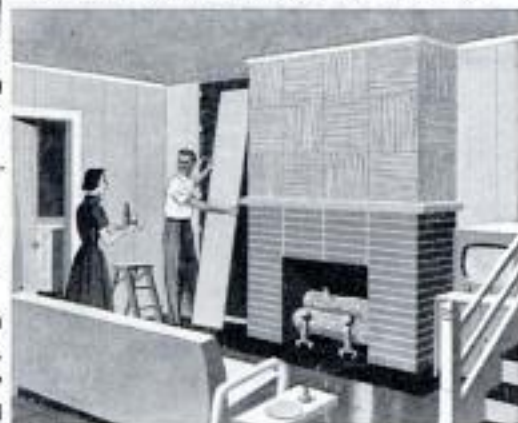

with
beautiful,
new
prefinished

MARLITE PLANK & BLOCK

Put them on the wall—that's all! Planks (16" x 8') and Blocks (16" square) go up fast over old or new walls with ordinary carpenter tools. No adhesive needed. An exclusive tongue and groove joint conceals all fastening. The soilproof baked Marlite finish never needs painting; cleans with a damp cloth. Ten beautiful "Companion Colors" styled by Raymond Loewy Associates, plus 4 distinctive wood patterns, are economical and practical for every room!

FREE! Mail postcard for folder and do-it-yourself instructions. Marsh Wall Products, Inc., Dept. 342, Dover, Ohio, Subsidiary of Masonite Corporation.

Marlite

PREFINISHED
WALL and CEILING PANELING

MARLITE PLANK AND BLOCK
PATENT APPLIED FOR



Paramount AIR COMPRESSOR

COMPARE Price — Features — Savings!

Reg. \$24.95. Ball bearing, piston-type compressor of revolutionary new design. Can't be matched as an all-purpose, low cost unit. New principle operates it on conventional 1/4 HP—5LT delivers MORE air than ordinary 1/2 HP unit. For professional paint spraying, tire inflating, insecticiding and hundreds other uses in shop, farm, home! Delivers 2 1/2 cu. ft. air per minute. Includes Tank—

\$12.95

Air Gauge and Air Regulator for adjusting pressure from 0 to 100 lbs. Order now and SAVE! Satisfaction guaranteed or money back. We pay postage. Electrical Equipment Catalog on Request.

ROBERTS ELECTRIC CO., 849 W. Grand, Dept. 151, Chicago 22, Ill.



SELL JUST ONE SENTRY SAFE A DAY AND YOU CAN EARN \$8,000 A YEAR!

ONLY 5% of the people own a personal safe to protect their valuables from fire, theft and loss! Cash in on this untapped market with SENTRY—the world's finest small safe. Prospects everywhere—householders, professional men, farmers, small businessmen. Set your own price, take a big mark-up, and still undersell all competition. Just one SENTRY sale a day can bring you \$8,000 a year. Choice, exclusive territory. Drop shipment if desired. Send for full details.



Write to Dept. PM-1
BRUSH-PUNNETT CO.
545 WEST AVE., ROCHESTER 11, N. Y.

Do YOUR gardening the EASY power way

BOLENS **NEW 1954**

POWER-HO GARDEN TRACTORS

featuring amazing



VERSA- MATIC DRIVE WITH REVERSE

POWER-HO SUPER
VERSA-MATIC
MODEL 15 FD

THERE'S A BOLENS TRACTOR
FOR EVERY GARDENING JOB

• POWERFUL • LIGHTWEIGHT •
SMOOTH SAFE OPERATION • LOW
COST • YEAR 'ROUND SERVICE



BOLENS HANDI-HO



BOLENS RIDEMASTER



BOLENS GARDENER



With this one-lever Versa-Matic control, a Bolens owner can choose any desired forward speed or reverse, without shifting, clutching or belt changing. All at full engine governed speed with no throttling down and loss of power. If operator releases handle when in reverse, tractor automatically goes into neutral—a great safety feature... Bolens offers 3 other Power-Ho Models, Too!

TRACTOR ATTACHMENTS

Bolens offers as many as 111 tools and attachments such as cultivator, disc harrow, circular saw and lawnmower.



AMERICA'S FINEST OUTDOOR
POWER EQUIPMENT

MAIL COUPON TODAY

BOLENS PRODUCTS DIVISION

Food Machinery and Chemical Corporation
265-3 South Park Street, Port Washington, Wisconsin

I am interested in literature on:

- TRACTORS POWER MOWERS
 TILLERS CHAIN SAWS

Name _____

Address _____

City _____ Zone _____ State _____

DEAR JOE:
LOOK WHAT I
CAUGHT WITH
MY NEW
PFLUEGER
SKILKAST
REEL



... a Muskie, 40 pounds, 57½ in. long—as tall as I am. Dad said I could fish like an expert right off the bat, but gee whiz! . . . didn't think it'd be that easy. No backlash, whatever that is, and boy, could I whip that bait right out where I wanted it. See you soon."*
Richard Harris, 12 yrs. old. 9264 Cheyenne, Detroit 28, Mich.

*Actual photo and testimonial, unsolicited.

PFLUEGER Skilkast REEL



...for EASIER casting. Adjustable, automatic Mechanical Thumber, a help to beginners; excellent for night casting too. At your sports dealer...\$12.25
Ask your dealer or send for illustrated folder.

ENTERPRISE MFG. CO., AKRON 9, OHIO

90 YEARS MAKING FINE FISHING TACKLE

DRILL SAW INTERNATIONAL REAM CUT

HI-SPEED COPE SAW DRILL BIT



DRILL, SAW, REAM . . . metal, pipe, wood, plastic, Transite, etc. Use with any electric drill, slow drill press, lathe or milling machine. Drills own starting hole—upper part of bit is used to cut, saw or ream circles, ovals, squares or scrolls. Easy to operate. Ideal for carpenters, mechanics, electricians, plumbers, hobbyists, many others. Abrasive resistant, high speed steel. Flutes ground from solid. Will withstand severe continuous use without breaking. Resharpens at no charge. Takes place of up to \$50 in tools. ¼" diameter, 2" cutting sections, total length 3½". Available in three types—All Purpose, Wood, Heavy Metal. Specify type needed. Set of 3, \$11.50. Details on request. Shipped same day. Money-back guarantee. Dealer inquiries invited. ORDER NOW! SEND CASH, CHECK OR MONEY ORDER.

Manufactured and distributed by
INTERNATIONAL TWIST DRILL CORP.
618 Wyandotte, Rm. 634, Kansas City 5, Mo.

only
\$3.95
POST PAID

BUILD THIS HOUSE Yourself

The Famous Popular Mechanics House

The picture below is from an actual photograph of the Build-It-Yourself House with breezeway and garage, as built by Jack Brownson, 23-year-old veteran, in Aurora, Illinois.



Mail Coupon for New Book and Plans!

Build It Yourself or Have It Built — Save Hundreds of Dollars!

Designed by Popular Mechanics and Famous Architects. Every Detail Simplified and Explained. No Previous Experience Needed!

Can you use everyday tools as well as the average Popular Mechanics reader? Then you, too, can easily build this modern house in any of its five designs, doing every part of the job yourself. The new Popular Mechanics Book, "Your Home—How to Build It Yourself" will show you how.

Space for Living and Family Growth

This beautiful, modern house is 1½ stories, with basement, living room, kitchen, dining nook, two bedrooms, bath, plenty of closets and space for two additional bedrooms on second floor. The house itself is 35' 9" x 28' 11"; breezeway 20' 10" x 8'; garage 20' 10" x 12'.

The House That Has Everything

Designed for easy construction and the most living space for the least cost, the Build-It-Yourself House is also most attractive and suitable for any community and most income groups. The basic plan is adaptable to four other exterior designs.

Get Book and Plans Now—Build When You Can

You may never have thought about actually building a house yourself, but now that building restrictions have been lifted, it is easier than you think. So order book and plans today. Even if you engage a contractor to build for you, you will need the plans. And you certainly will want the book which can easily save you hundreds of dollars, whether you build this or any other house.

PLANS YOU CAN READ AND FOLLOW

Plans consist of ten working-size blueprints—floor plans, elevations, construction notes, framing, joints, lumber and mill list, specifications, plumbing and wiring diagrams. Every measurement is marked—every detail made clear as ABC. Book has 100 pages—three-fifths are photographs and drawings. Some sections in colors, showing just how your house will look when finished.

BIG BOOK
8½ x 11 inches



MAIL COUPON FOR BOOK AND PLANS

POPULAR MECHANICS PRESS, Dept. 16
200 E. Ontario St., Chicago 11

I enclose \$_____ Send me the items checked at once.

- Your Home and How to Build It Yourself.....\$ 3.00
 Complete set of plans for Popular Mechanics Home... 12.50
 Book and plans at reduced price..... 14.00
 Duplicate sets of plans..... 5.00

Name _____

Address _____

City _____ Zone _____ State _____

New Formula Zips Off Paint!

X-CELL-ALL

No-Wash Remover

with

Dow Methylene Chloride



Remove old paint, varnish, lacquer, shellac with amazing X-CELL-ALL. Safe—won't burn! Start repainting as soon as old paint is off. Won't harm woods. At paint and hardware stores. Or send check for \$4.25 gallon, \$1.25 quart. Shipped postpaid. No C.O.D.'s.



Luminall Paints

CHICAGO 9, ILL.

SAY YOU SAW IT IN
POPULAR MECHANICS

What to Make with CONCRETE

Even little concrete jobs cost big money—mostly for labor. Get Popular Mechanics **WHAT TO MAKE WITH CONCRETE** and save all the labor cost while making your home or farm ship-shape. Book shows all—tells all—how to make the right mixture, plan, apply and gives 50 professional short cuts. Hundreds of pictures. Only \$2.00 postpaid. Order today. Money back if not pleased.

POPULAR MECHANICS PRESS, Dept. PM9, 200 E. Ontario St., Chicago 11



Build Your Own Fireplace, Driveways, Walks, Etc.

BUILD YOUR OWN ARC WELDER OR LIGHT PLANT



Give \$250 to \$500
\$15.50 used, good cond.
Instruc. incl. for Comb. welder & light plant, 200 amps, 25 Volts. Or Small \$21.50
New.....Price
PRICE F.O.B. K.C., MO.

CONVERTS TO ARC WELDER 200-250 AMP.
OR LIGHT PLANT CAP. LOAD 5000 WATTS

Stock #511 A.C.-D.C. Generator. Mfg. by General Electric. Rated 1250 Watts, 10.9 Amps, 115V. A.C., 200 Amps, 30V. D.C. Converts to dependable 115V. A.C. Light plant and D.C. Battery Charger. Gov't. cost, \$300.00, instructions incl. Wt. 50 lbs. Used, good condition... **\$25.50** NEW, **\$35.50**

CORNELIUS AIR COMPRESSOR
2 Stage Piston type including 1/2 HP motor, pressure tank pop valve & fittings. Rated pressure 1500 P.S.I. with 1/2 HP 27 V DC series motor. For DC & Applicable for 110 V. A.C. or for belt drive with separate motor. Ideal for spraying, inflating & wherever compressed air is needed. Instructions incl. Gov't. cost over \$150.00... **\$21.50**

Send check or M. Order. Prices f.o.b. KCMo except when marked postpaid U.S.A.

GENERAL SALVAGE CO., Dept. 734, 2922 E. 27 St., Kansas City, Mo.

BEAM ROTATOR MOTOR. Powerful, reversible, free swing geared motor for TV aerials, Ham, FM, etc. Light weight 2 P.P.O.X. R.P.M. incl. 3 mounting lugs. Applicable for 24 V DC and 110 V. A.C. Gov't. cost over \$100.00. Stock #272. Inst. incl... **\$14.50**

Stock No. 711 D. C. Generator. R-1 Jack & Heintz, rated 300 Amp. 30 Volts. Gov't. cost \$300.00. Instruc. for converting to welder or light-plant incl. **\$27.50**

RHEOSTAT R-27
Heavy duty for regulating the voltage on the converted P-I, R-I welders, or AC-DC type. Post-Gov't. cost... **\$6.95** paid

CUNO OIL FILTER—BRAND NEW Aircraft type. Filters oil without cartridge replacements. Just turn handle and cartridge is clean. Std. 3/8" inlet & outlet ports. Inst. incl... postpaid **\$4.95**

SAVE OVER 50%

ON EXTRUDED ALUMINUM Self-Storing Combination STORM WINDOWS and SCREENS



Complete DO-IT-YOURSELF KIT

INCLUDES HARDWARE; ALL PARTS FACTORY CUT, DRILLED, MITERED—EASY ASSEMBLY WITH ONLY SCREWDRIVER & PLIERS

Just **\$9.95** (fob factory) per window regardless of size, other than picture windows. COMPLETE except for glass. Orders of 5 or more sent postpaid.

Enjoy all combination window comforts, conveniences, safety, economies for years of "winter-summer service" at a price that saves you better than 50%. COMPLETE HOME INSTALLATION PAYS FOR ITSELF. Send coupon for FREE Measurement Chart, descriptive folder.

EXTRA CASH FOR YOU!
Assemble and install windows for friends, neighbors

U-FAB-IT-URSELF, INC.

Post Office Box 209
WORTHINGTON, OHIO

FREE—FOR ACTION NOW!

Please rush me your free Fab-It-Urself Booklet and Measurement Chart.

Name

Address

City State

PM-354



YOUR CAR NEEDS



FOR FAST AND EASIER STARTING . . . AND A SMOOTHER, MORE POWERFUL MOTOR



NO FUSS—NO MUSS—JUST POUR—NO MORE

• More Miles Per Gallon . . . Due to More Efficient Carburetor Operation • Cleans Clogged Carburetors and Gas Lines Without Removing Carburetors • Dissolves Gum and Varnish Thus Reducing Frictional Drag and Wear • Eliminates Water in the Gas Tank and Fuel System • Gas Tank Anti-Freeze • Rust Proofs Fuel System. Also an Excellent Parts Cleaner for Parts and Equipment and Ideal for Heavy Duty Cleaning Around the Home.

PROTECT YOUR CAR NOW — Buy Carb Master at your local Service Station. Ask Your Service Station Operator About RUST MASTER, SLUDG-MASTER and LEAK MASTER

If he cannot supply you, write for name of nearest dealer.



PRODUCTS WORK WHILE YOU RIDE

Chemical Company
Mfg. Chemists

56 CROFTON ST., CAMBRIDGE, MASS.

THE SILENT PARTNERS OF MOTOR EFFICIENCY

BUILD IT YOURSELF AND SAVE

3 Bedroom Home

1990⁰⁰ Model 101

(Plus freight and sales tax if any.)

PRE-CUT AND PANELIZED FOR EASY ERECTION

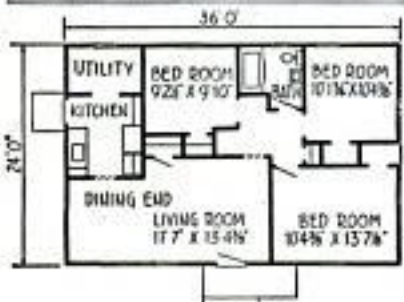

Erect this home in 2 days with the help of a few friends—move in—then finish it at your leisure. Exterior walls fabricated with sheathing, builders' felt and asbestos shingles applied, in choice of colors. Windows installed, interior partitions assembled, erection drawings and specifications furnished and all lumber marked for easy erection.

Choice Territories Still Open For Representatives

Send \$1.00 for PLANS and material list to:

LUMBER FABRICATORS, INC.

ECONOMY DEPT. **A3** FORT PAYNE, ALA.

The Most Fascinating Book About the Automobile Ever Printed!

Popular Mechanics

AUTO ALBUM

The Motor Car in Picture and Story from 1769 to 1952



You'll Find..
the Answers... the Fascinating Stories . . . in the **AUTO ALBUM**

Who built the first horseless carriage?

Who obtained the first U.S. patent on an automobile?

Where did the name "automobile" come from?

Are you familiar with the workings of the Stanley Steamer . . . the "electrics" . . . the famous Ford Model T?

Do you know when the first Indianapolis race was won . . . by whom . . . at what speed?

Do you know the story of Henry Ford, Barney Oldfield, Ransom Olds, Walter Chrysler, W. C. Durant and other automotive giants?

166 Illustrations Including 94 Old-Time Cars — 22 Auto Ads of By-Gone Days!

Here is a book you can't help enjoying and wanting, whether or not you have, or ever will own an automobile. It is the fascinating, thrilling and informative story of the horseless carriage from the first gasoline-propelled buggy to a forecast of the atomic car of the future.

Popular Mechanics **AUTO ALBUM** by Throm and Crenshaw presents America's first cars and the pioneering men who made them; the scrambling start and the development of the fabulous auto industry; the story of automobile racing; the growth of the Nation's highways. It is a book that just had to be published.

To Read . . . to Enjoy . . . to Remember!

More than one-half of the book is pictures, most of them action pictures, from photos of old-time cars in operation. Other pictures show race cars from 1911 to 1951; early auto advertising, picturing 32 cars priced from \$375 to \$6000; tri-cycle autos, wind wagons, auto cycles and other automotive oddities. A roll call of horseless carriages is included — the names of more than 2000 cars made in the United States.

Gift Book of the Year

Get the fascinating **AUTO ALBUM** for yourself today. Send it as a gift to friends and business associates. Order on coupon below. Money refunded if you are not entirely pleased.

Cloth Binding



Use Coupon to Get AUTO ALBUM

POPULAR MECHANICS PRESS, 200 E. Ontario, Chicago 11

Send at once postpaid _____ copies of Popular Mechanics **AUTO ALBUM** at \$3.00 each. Remittance enclosed. Send COD. I will pay postman plus charges. I understand books are returnable in 7 days for full refund if I am not pleased.

Name _____

Address _____

City _____ Zone _____ State _____



Model 800
20 to 600 Power
\$39.95 postpaid



Model 300
100-200-300
\$9.95 postpaid

AN intensely fascinating hobby that everyone can enjoy. Even the most inexpensive microscope listed in this advertisement will allow you to see the invisible micro-animals in a drop of water!

FREE!—Micro-Manual
Mailed on request or included with your order. Tells how to use a microscope, how to make your own slides.



FREE!—
44-Pg. Catalog. Mailed on request or included in your order. Microscopes, optics, slide making materials at down-to-earth prices.

ADVENTURE IN THE MICRO-JUNGLE!



Model 635
150-300-600
Power
\$29.95
postpaid

HARDWOOD CABINETS are included in the purchase price of all instruments shown. Mechanical stages are \$14.95 extra. 20 blank slides (make your own), \$1.00. Set of 12 prepared slides (animal and plant subjects), \$4.95. All postpaid.



Mark III
20 Power Telescope, spiral focus, coated lens in fitted hardwood case
\$9.95 postpaid

Heidelberg
20 to 2000 Power
\$319 postpaid



10-Day Money-Back Guarantee
Send check or M. O. 1/3 deposit on C.O.D.'s Calif. resid. add 3% state tax. All instruments made to our own rigid specifications and designs by the Japanese optical industry.

the AKRON 76 AKRON BLDG.
4379 SUNSET BLYD., LOS ANGELES 27, CALIF.



Von Stueben
25 to 1200 Power
\$89.50 postpaid

BUILD IT FIX IT with AMBROID

- Ready-to-use
- Fast drying
- High tensile strength
- Transparent
- Waterproof

IT STAYS STUCK

Dries entirely by evaporation of the solvent. Quick setting—no distortion. Ideal for assembling, repairing, home crafts, electrical work, factory, workshop or household use. Send postcard for free literature.

E.I.E. Try Ambroid in your business, too. For over 40 years recognized as the leading industrial adhesive of its type.

Art galleries, museums, and leading industrial concerns, rely on AMBROID

TRY A TUBE TODAY—At most hardware stores and hobby shops. If your dealer cannot supply you, send 30c for big 2 oz. tube, postpaid. Money back guarantee.

AMBROID 303 FRANKLIN ST. BOSTON 10, MASS.

Remodeling BOOM!

Your Big Opportunity to enter FLOOR SURFACING PROFESSION as YOUR OWN BOSS at BIG PAY!

Twenty million dwelling units need remodeling and repairs including resurfacing of old worn floors. Also, new construction continues to boom. This means a lifetime opportunity to establish yourself in a fine business that pays you well . . . sanding floors with an easy-to-run American machine! Steady year 'round work where profits are limited only by the time you spend. Full or part time opportunities. No schooling or special skills required. Only small investment in sander gets you started. Send for booklet "Opportunities in Floor Surfacing," enclosing 25c in coin or stamps to cover handling.

SEND.. AMERICAN

FLOOR SURFACING MACHINE CO.
535 So. St. Clair St., Toledo 3, O.

DO IT YOURSELF with the tool that
**GRIPS, TWISTS, BENDS,
PULLS and CLAMPS**

METCOID LEVER JAW WRENCH



EASIER! FASTER! BETTER!

Metcoid Lever Jaws are custom made for a thousand and one jobs! Forged steel jaws adjust precisely to objects' shape. Double leverage . . . multiplies hand pressure to ton grip, holds with amazing dependability! 7 tools in 1—clamp, toggle press, pipe wrench, locking wrench, pliers, adjustable wrench and gripping tool.

**E-Z ACTION
RELEASE**
opens with
a flick of
the finger.

patent no. 2592807



Straight Jaw
Welder's Jaw
Curved Jaw
Double Pipe
Jaw

Insist on the
genuine **LEVER JAW!**
See the complete line
at your favorite dealer.

METAL ENGINEERING CO.
134 N. La Salle St.
Chicago 2, Illinois

For work-free masonry drilling



Use new
**CARBOLOY®
Masonry Drill**

Even drills concrete like wood!

Now . . . rotary drill any masonry in your home with ease! New Carboloy Masonry Drills bite cleanly through brick, slate, tile, concrete or cast stone. Won't stick, stall, bind.

Super-hard carbide tip gives extra-long use. Lets you drill holes at any angle . . . to bolt down washer, dryer, tubs . . . fasten hooks, screens, awnings, trellises . . . attach bath, kitchen fixtures, partitions, furring strips, etc.

Get "Handy-Man" Kit today. Contains 3 drills: 1/4", 3/8", 1/2". Fit 1/4" chucks. \$6.65 per kit. Send coupon, or see your hardware dealer.



"Carboloy" is the registered trademark for products of the Carboloy Department of General Electric Company

MAIL THIS COUPON TODAY

CARBOLOY

DEPARTMENT OF GENERAL ELECTRIC COMPANY

11185 E. 8 Mile Road, Detroit 32, Michigan

Send me Handy-Man Kits at \$6.65 per kit, postpaid. Enclosed is check or money order for _____ Send C.O.D. Send me free folder.

Name _____

Address _____

City _____

Zone _____ State _____

Save on all PLUMBING JOBS

When You Build · When Making
Improvements · Repairs · Maintenance

Get
POPULAR MECHANICS
**Home Plumbing
Guide**



How to plan
plumbing in-
stallations, se-
lect materials
and fixtures.

How to save money on all plumbing jobs using approved methods.

**Easy to Do Professional-Like Jobs
and Save Over One-Half**

Get the Popular Mechanics HOME PLUMBING GUIDE. It shows how you can do every kind of plumbing job yourself and save from a few to hundreds of dollars. Covers plans, layouts, installation, maintenance and repair. Shows what materials to get and use, where to get them and how to do a proper job with approved methods. Few, other than the simplest tools are required and

some of these can be rented. Don't pay high prices for work you can do yourself. Get the HOME PLUMBING GUIDE for only \$3.50. You will be amazed how jobs you thought difficult are simplified.

**Clip This Ad and Mail. Money
Back if Not Pleased**

Invest only \$3.50. Use the book for 7 days. Then if you are not satisfied return it for full refund of your money. Sent C.O.D. (U.S.A. only) if you prefer.

Over 500
How-to-do-it
Pictures Guide You



POPULAR MECHANICS PRESS, Dept. HPG-10, 200 E. Ontario St., Chicago 11

Save Hundreds of Dollars On Home Repairs . . .

Add to Your Home's Beauty and Comfort
. . . Increase Its Selling Price

Here is the last word in dependable, money-saving help for the homeowner. Guide to Home Repairs, written by the editors of Popular Mechanics, gives you the know-how you need to repair and maintain plumbing; install and repair wiring; paint and decorate; install insulation, etc.

**Step-by-Step Instructions
Tell How — Pictures Show How**

First you read how to do it in the famous Popular Mechanics "Written So You Can Understand It" style and then hundreds of photos, drawings and diagrams show you how it is done. Nothing is left to the imagination. Now you can lay floor tile and linoleum, repair doors and windows, tuckpoint, repair and install gutters, etc. Order your copy today. If it isn't entirely satisfactory you may return it in seven days for a full refund.

192 Pages
646 Illustrations
\$2.50



POPULAR MECHANICS PRESS, Dept. HR-1
200 E. Ontario St., Chicago 11, Ill.

Send at once my copy of Guide to Home Repairs. My remittance for \$2.50 is enclosed. If it isn't satisfactory I may return it in 7 days for a full refund.

NAME _____

ADDRESS _____

CITY _____ ZONE _____ STATE _____

Check here for C.O.D. shipment. (U.S.A. only). Postage extra.

**How To
Paint Easily,
Quickly,
Professionally**

THOMAS PAINT ROLLERS apply all paints perfectly on any surface... and save you time, money, effort, fatigue. No experience necessary—just roll it on!

BE SURE YOU BUY THOMAS at your Paint, Hardware, Lumber dealer.



THOMAS PRODUCTS COMPANY
8490 Lyndon Ave. • Detroit 21, Michigan

Say You Saw It in Popular Mechanics

**Make BIG SAVINGS With
FACTORY-DIRECT PRICES!**



HAND WINCHES AT FACTORY PRICES
3 to 1 ratio, 700 lb. pull. Drum has 1 1/2" spool, 6" flange. Takes 75 ft. of 3/16" cable. Stop locking pawl. . . . \$16.45
24 to 1 ratio. Worm drive, 1000 lb. pull. Width 11", depth 7 1/2", height 7 1/4". \$28.00
10 to 1 ratio. Super-duty 4000 lb. pull. Double drum, with jaw type clutch. Wgt. 250 lbs. . . . \$49.50

Electric Winches — Direct-to-You Prices
1/2 HP Electric Ball Bearing. Compact gear box. 12 RPM drum speed. . . . \$145.00
3/4 HP, same as above. More lifting power, greater speed \$185.00
Super-duty 3/4 HP Ball Bearing, with 24 to 1 worm gear reducer. Length 36", width 26", height 17". Pull 3500 lbs. Complete with 100 ft. of aircraft cable, up-and-down buttons. . . . \$245.00
(All electric motors Heavy-Duty, Repulsion-Induction, Instant Reverse)

Complete Stock of Limit Switches, Magnetic Brakes, Magnetic Reversing Switches, Aircraft Cable.
CABLE 3/16" pre-formed aircraft cable. . . . 17c ft.
5/16" pre-formed aircraft cable. . . . 12c ft.

HOT ROD SUPERCHARGER

Extra soup and go at a price you can't afford to miss! Mfr'd by Borg-Warner. Specifications: 7 1/2" deep, 7" high, Wgt. 17 lbs. Compact and sturdy, 4 base mounting holes, 3/4" outlet, 3/8" shaft with female Loveloy coupling. Priced today at \$85. SPECIAL! NEW only \$31.00 USED \$18.95



Here are only a few big \$\$\$ savings! More in our catalog!

Air Compressor	Electric Motors	Hand Truck	Rubber Cable
Air Tank	Electric Switches	Hydraulic Cylinder	Rubber Wheels
Block & Tackle	Elevator	Hydraulic Stackers	Saw Tables
Blowers	Drawing	Hydraulic 1 Beam Trolley	Shower Sprays
Bomb Trailer	Elevator Incline	Lawn Mower	Starters
Buzz Saw	Fans, Exhaust	Sulky	Tools
Compressor	Fans, Heat	Magnetic Starter	Transformers
Accessories	Booster	Mail Chain Saw	Whiting Hoist
Clutches	Gas Engines	Mail Grinder	Winch, Electric
Conveyors	Grinders	Pumps	Winch, Hand
Delta Tools	1/2 Ton Wagon	Reduction Gear	Fire Extinguisher
Drop Cords	Male Fire Pump		4 Wheel Trailer

Get this catalog! 72 pages, packed with useful charts, information, plans for dummy & incline elevators, more than 1100 tools and equipment items at money-saving, factory-to-you prices. Send 25c (refund with first order) or write on company letterhead for free copy.

C&H ELECTRIC MACHINE Co. Inc.

434 W. Juneau Ave., Milwaukee 3, Wisconsin

Send For Your Copy of the
FREE NEW 1954 4-Color
CATALOG of
MIDWEST
TELEVISION and RADIO
Receivers Featuring BIG 21" and 27"
TV Consoles, Table Models and
Complete CHASSIS



**30 DAYS TRIAL
EASY TERMS**

YOUR CHOICE of 12-Channel VHF or All-Channel VHF-UMF Models

The most magnificent line in Midwest's 34 years of radio and television manufacturing. Your choice of genuine Mahogany veneer, Walnut finish, or Blond Lined Oak cabinets. **FACTORY-TO-YOU.**

MIDWEST World-Ringing RADIOS



SEND THIS COUPON ON 2c POST CARD FOR NEW 1954 FREE 4 COLOR MIDWEST CATALOG

MIDWEST RADIO & TELEVISION CORP.
Dept. M-25, 909 Broadway, Cincinnati 2, Ohio

NAME _____
ADDRESS _____
CITY _____ ZONE _____ STATE _____

HELPFUL BOOKS

Send post card asking for FREE catalog
Popular Mechanics Press, 200 E. Ontario, Dept. 601, Chicago 11

TRIPLE ELECTRODE

LUTHY AERO SPARK PLUGS

with ALUMINUM OXIDE INSULATORS
Just what your car needs—for extra "zip and go" and lasting power. **THREE TIMES LONGER LIFE.**

Give better performance and last longer because of these features:

- **3 POINT ELECTRODES.** Tapered points for better spark and 3 times longer life.
- **"LUM-OX" INSULATORS.** Used exclusively in the LUTHY AERO SPARK PLUG. First used in combat aircraft during World War II. Keep plugs cool by fast thermal conduction. Highly resistant to mechanical shock, too.
- **CHROME PLATED.** For resistance to rust.
- **NO GAP SETTING NECESSARY.** Every set perfectly engineered for your make and model at the factory.



Pat. App. For
SET OF 6 \$5.34
SET OF 8 \$7.12
Postpaid

LUTHY AERONAUTICAL SALES COMPANY
302-3 COOPER ST., JACKSON, MICH.
CANADIAN ADDRESS: BOX 304, HAMILTON, ONTARIO

Send me a set of _____ plugs. Enclosed is \$ _____
 Check here for C.O.D.

Name _____
Address _____
Year of car _____ Make and Model _____

WHEN IT COMES TO WOOD
FILLERS THERE'S NO
SUBSTITUTE FOR PLASTIC WOOD!



Plastic Wood is stronger—resists weather. Sands down to a smooth, hard finish. Professional craftsmen have preferred Plastic Wood for more than 50 years because it takes paint, varnish and other finishes best. Will not chip, crack or peel . . . won't pull away! In cans and tubes.

In Natural and 8 wood colors!

"PLASTIC WOOD"®

NEW TOOL READY!

Industry's Handy, All'Round Machine

Now Available
To Home Shops!

The world-famous Mead Bandsander—used by industry—is at last available to you for home workshop use! This remarkable machine quickly shapes, sands, carves and polishes wood, metal, plastics! Works equally well on inside cut-out openings or irregular outside edges. Gets at places no other can! Tilting table for bevelling, chamfering. Rust-and-sweat proof top. Self-oiling. Saves time, labor, money on jobs in any home or industrial shop. Invaluable to home craftsmen, makers of patterns, tools, dies, signs, costume jewelry, castings, forgings, ornaments, radio and electrical parts, stampings, etc. Nothing else like it. Sold on 5 Day Trial, money back guarantee. Circular Free! Cuts Fast and Clean . . . Saves Filing, Sanding Work

QUICKLY
SHAPES,
SANDS,
CARVES,
GRINDS,
PROFILES,
CLEANS,
SMOOTHS, and
POLISHES
WOOD! METAL!
PLASTICS!

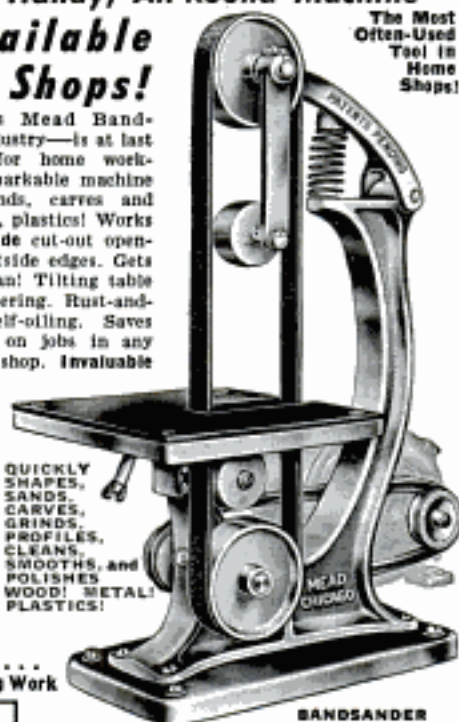

BANDSANDER

Write for FREE Circular

Send for free details on "the machine that amazed the experts!" Rush a postcard today for Circular, surprisingly low price. Hurry!

MEAD SPECIALTIES CO.
4114 N. Knox Ave., Dept. BA-3, Chicago 41, Ill.



*Now You Can Upholster
Any Piece of Furniture!*

**Upholster—Restyle Any
Piece of Furniture Yourself**

John Bergen, custom furniture designer, tells and shows you how to transform old out-of-date furniture into brand new smart-looking comfortable furniture in his new book **ALL ABOUT UPHOLSTERING**.

No Experience Needed

Bergen tells you every step to follow in amazingly clear easy-to-understand step-by-step instructions and then shows you how in hundreds of big, clear drawings and photos. You read and see how to strip the old frame, install new webbing and springs, apply burlap, install stuffing and padding, fit the muslin cover and the final fabric and install trim.

Use New Materials—Methods

Now you can have furniture upholstered with foam rubber, sagless springs and other new materials that add so much to comfort and durability and are so costly when included in new furniture.

Save 50% of Usual Cost

Don't pay a small fortune for new furniture when you can make your old furniture better than new! Why pay high prices to have someone else upholster and restyle your old furniture when you can do it yourself for cost of materials alone? It's easy and it's fun.

Special Chapter on Slipcovers

Learn how to make custom-made slipcovers with professional look and fit. Find out how you can realize tremendous savings by investing a few spare-time hours and the cost of a few yards of fabrics.

7-Day Money Back Guarantee

Send for your copy of **ALL ABOUT UPHOLSTERING** today. Read and use it for 7 days. If it isn't entirely satisfactory return it for a full refund.



USE THIS HANDY ORDER COUPON

POPULAR MECHANICS PRESS, Dept. AAU
200 E. Ontario St., Chicago 11, Illinois

Gentlemen:

Please send my copy of **ALL ABOUT UPHOLSTERING**. Enclosed is my remittance of \$3.50. If I am not completely satisfied with the book I will return it for a full refund after 7 days.

Name _____

Address _____

City _____ Zone _____ State _____

Install Your Own AUTOMATIC DRIVE!

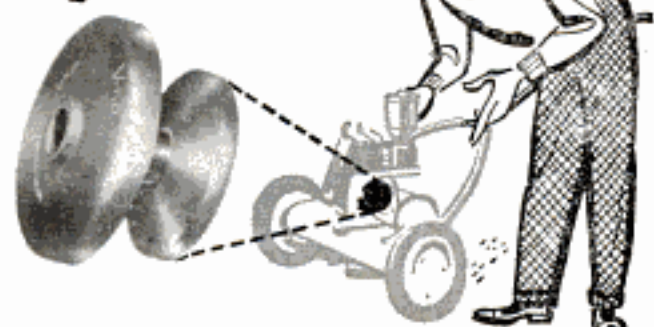

REPLACE THAT OUT-DATED BELT TIGHTENER or troublesome clutch! Get smooth, positive pickup. Prevent stalling . . . prolong belt life . . . get one-pull starts. V-PLEX clutches are easy to install on $\frac{3}{4}$, $\frac{5}{8}$, $\frac{3}{4}$, 1" shafts. Trouble-free in use . . . every clutch factory tested! 500,000 in use on over 20 famous powered units. 5,000 dealers!

\$7.95

and up

See your engine dealer or write for Folder M3.

V-PLEX CLUTCH DIVISION
Hagerstown, Indiana

What Every Farmer Should Know About Taking Care of Farm Animals



The Most Popular Veterinary Guide Ever
Printed

This practical and helpful VETERINARY GUIDE FOR FARMERS prepares the farmer to perform many routine veterinary tasks—provides quick information that can often save the life of an animal—prevents disease in herds—saves money on the farm in a hundred different ways. Written in plain understandable language. It covers symptoms, causes of disease and prevention, and treatment of cattle, swine, sheep, horses and poultry and worms when to call in the professional veterinarian. Names, terms and phrases made clear in a separate section. Over 100,000 copies of this book are in use on American farms. 275 pages. Fully illustrated. Only \$3.95. Order today under money-back guarantee.

POPULAR MECHANICS PRESS, Dept. PM13
200 E. Ontario St. Chicago 11, Ill.

WAR SURPLUS AND OTHER **SALE** BARGAINS SAVE UP TO 90%

AIRESEARCH LINEAR ACTUATOR

Open and close garage doors, remote control of industrial machines, marine use, displays, etc. Motor drives actuator in a 0.5" travel through a reduction gear box. Wealth of gears. 24 Volt, 13 Amps, 1750 lb. lift. Wt. 8 1/2 lbs. Approx. GOVT. COST \$150. While they last—\$5.95.

"HELIOS" ORIGINAL TOOLMAKERS VERNIER CALIPERS

ULTRAPRECISION—Imported. Used by machine lists at Lockheed, Douglas, Bendix, GM, RCA, GE. Model 51/2E. Genuine Helios. Hardened lapped precision surfaces. 1/1000" and 1/128" graduations. Handy slide roll and thumb lock. Quick, accurate depth. A \$35 value. Satin finish. ALL NEW, just \$6.50. Leather carrying case, \$1 extra.

Carbon Pile Generator VOLTAGE REGULATOR

Adjustable from 24 to 32 volts. For use with 24 or 32 volt D.C. Generators; also 200 Amp-300 Amp type generators to build your own light plant. Marine use. Westinghouse. Wt. 2 1/4 lbs. Approx. GOVT. COST \$50. Now only \$4.95 ea.

GEAR HEAD MOTOR

Use to run antenna, open or close doors and windows, Barbecue, displays, etc. Approx. 1 RPM. Set for 140° turning with limit switches that remove for full 360° turning. 1 Amp. 24 volt D.C. 1/2 in. shaft dia. 3" RPM. 1/10 HP motor, micro-switches, reduction gears, mounting brackets—hobbyists! Barber-Coleman. Approx. GOVT. COST \$90. Like new, only \$3.50.

LOW VOLTAGE CIRCUIT TESTER

Made for U.S. Ordnance. Self-contained device makes complete & rapid check of generator battery circuit. Will check out any 6 or 12 volt system, Garages, mechanics, truck fleet owners, boat & marine mechanics. Guaranteed perfect. Shpg. Wt. 20 lbs. Approx. GOVT. COST \$175. NEW, complete with steel carrying case & instruction book, WHILE THEY LAST—\$29.75

D. C. GENERATORS—\$14.95

All these generators will weld plate steel or better. Can be used as combination welder & light plant. Generators like News, P1. Perfect. 200 Amps. 28 Volts. 2500 to 4500 RPM. Wt. 53 lbs. Approx. Govt. Cost \$350. Now \$14.95
Electric Auto-Lite. 200 Amps. 24 Volt. 2500 RPM. Dandy arc welder. Wt. 53 lbs. Approx. Govt. Cost \$450. NEW—\$20.
E1 Jack & Heintz. Rated 300 Amps. 30 Volts. Wt. 60 lbs. Approx. Govt. Cost \$450. Guaranteed perfect \$23.50

MAKE YOUR OWN ARC WELDER Package consists of 1 NEW Auto-Lite P1 generator, 1 giant toggle switch, 1 voltage regulator, wiring diagram chart showing conversion of Aircraft Generator to Arc Welder. SPECIAL—\$29.50

MICROMETERS Chrome plated, precision engineered, carefully tested to give long life. All new 0-1" cap. \$2.25 ea., 1-2" cap. \$3.50.

Send 25¢ for big catalog. Bargains for everyone. Check, Money Order or Cash. 25% deposit on C.O.D. orders. Prices F.O.B. Culver City, Calif., Unless otherwise stated.

AIRBORNE SALES CO., INC. Dept. PM354
8501 Stellar Dr., Culver City, Cal.

Our 703rd Advertisement REAL DIESEL ENGINE

\$3.95

- for planes, boats, midget cars
- 7500 RPM; 1/7 HP; ht. 3 1/2"; wt. 8 oz.
- precision machined for smooth operation

You just can't beat this price for a precision diesel engine! Streamlined, compact, easy to install. Thousands of satisfied users all over the world. Fast delivery if you ORDER TODAY! Send \$3.95 plus 25¢ postage.

GOTHAM HOBBY CORP. Dept. P, 107 E. 126th St. New York 35, N. Y.

NEEDS NO TANK!

Cost LESS to buy
—LESS to install

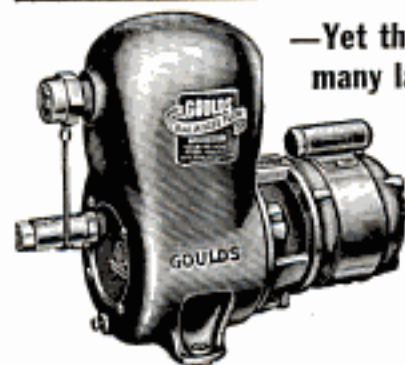

—Yet this amazing pump outperforms many larger, costlier water systems!

GOULDS Balanced-Flow Jet is a full-capacity, shallow-well water system—yet small enough to install anywhere—with no costly tank, fewer fittings to buy. Self-adjusting flow delivers exact amount of water wanted at all outlets at the same time, within capacity! Self-priming, trouble-free, quiet—only one moving part. Send coupon today!

GOULDS water systems

Goulds Pumps Inc., Dept. PM-4,
Seneca Falls, New York.

Send free, 20-page booklet on Balanced-Flow and other Goulds Pumps. Also distributor's name.

Name.....

Address.....

BUILD YOUR OWN POWER TOOLS— WITH GIL-BILT

Exclusive GIL-BILT Build-It-Yourself Features

- No machining—build easily with hand tools only
- No blueprint reading—step-by-step pictorial plans, full scale patterns, actual photographs
- Sturdy wood, aluminum and steel construction
- Capacity and performance of commercial saws selling for \$80 and up
- Proved performance. Nationally advertised and sold for 6 years. Satisfied customers around the world.

PARTS KITS

PLANS only
\$1.00 EACH
POSTPAID

10-INCH TILT/ARBOR SAW



- 27x28 in. table, 13 1/2 in. capacity in front of blade
- 10 in. blade cuts 3 1/4 in. deep, tilts full 45 degrees
- Floor model 34" high, table always stays level
- New Departure ball bearing arbor, 3/4" precision shaft turned down for 5/8" bore blades, alum. housing, shipped ready to run
- Jackscrew and 4 1/2 in. dia. hand-wheel lowers and raises blade
- Cast aluminum miter gauge and self-aligning rip fence guide

GIL-BILT Metal Parts Kit includes Plans, ball bearing arbor, miter gauge and bar, rip fence guide, dado insert, lock knobs, jackscrew mechanism and handwheel, and all other metal parts (less blade).....\$22.95

Same Kit with 10" Combination Blade.....\$25.90

Same Kit with 8" Combination Blade.....\$24.90

12-INCH BAND SAW

- Cuts to center of 24 inch circle
- Handles stock up to 6 inches thick
- 18x18 inch table tilts 45 degrees
- Lower wheel and drive pulley runs on sealed New Departure Ball Bearings: Upper wheel runs on two 5/8" bore Oilite Bronze bearings
- Upper wheel tension and tilt mechanism of cast aluminum, completely assembled
- Upper and lower blade guides. Each has ball thrust bearing, self-lub bronze jaws
- Rigid cast aluminum wheels fully machined ready-to-install. Heavy rubber tires
- Uses standard 78 inch blades up to 3/4 inch wide
- Fully enclosed mechanism for utmost safety

GIL-BILT Metal Parts Kit includes Plans, rubber tires, aluminum wheels, 1/4 in. blade, ball bearing spindle, tilt mechanism, blade guides, table tilt segments, and all other metal parts.....\$23.95



ALSO AVAILABLE
Plans & Parts
Kits for 18-in.
Band Saw, Belt
Sander, 8-in.
Tilt-Table Saw

Return Kits in 10 days for refund if not satisfied.
For shipments up to 600 miles, add 5%; over 600 add 10%
Amount in excess of actual postage will be refunded.
Order Kit now, or order Plans at \$1.00 each and
Kit later less cost of plans, Write for FREE Catalog.

GILLIOM POWER TOOLS

P. O. Box 1-PC, Lambert Field
St. Louis 21, Missouri

SAY YOU SAW IT IN
POPULAR MECHANICS

SURPLUS! New Release! Original Gov. Cost \$350.00

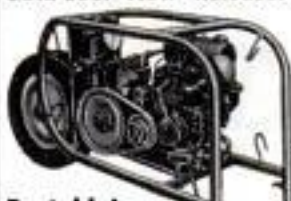

AIR COMPRESSOR

200 lb. Pressure, 2 Horsepower

Finest 2 HP
TWIN CYLINDER
Industrial Unit \$129.00
ever built!

Portable!

Fully Guaranteed

5.3 C.F.M. Handles largest industrial and commercial applications

Made by BENDIX WESTINGHOUSE to rigid specifications. A BUY for Contractor, Farm, Garage, Service Station, Factory, Shop! Two independent air outlets—one for high pressure (up to 200 lbs.)—the other controlled by regulator from 0 to max. 5.3 C.F.M., supplies sufficient air to maintain 40 to 65 lbs. pressure for CONTINUOUS spraying (no waiting until tank keeps building up). Large face gauge. Adjustable Safety release valve. Automatic unloader (adjustable up to 300 lbs.) keeps pressure constant without stopping engine. Hollow frame acts as reservoir assuring large supply of OIL-FREE air with ABSOLUTELY NO PULSATION! Unexcelled for: Spraying; Greasing; Tire inflation; Blowing out heating and refrigeration lines; Small pneumatic tool operation; Insecticide dusting and spraying; Flocking; Undercoating!

SPECIFICATIONS:

- | | |
|---|---|
| <ul style="list-style-type: none"> • Mfg. by BENDIX WESTINGHOUSE • Twin cylinder • 4 Rings on each piston for added compression—capable of pumping 1100 lbs. p.s.i. • Forced pressure lubrication assures oil to every moving part • Ball bearing construction • Capacity 5.3 cu. ft. | <ul style="list-style-type: none"> • Mfg. by BILGGS & STRATTON • Kick or rope start • 2 HP, 4 cycle air cooled • Splash lubrication system • 2 qt. gas tank • Float feed carburetor with adjustable idle speed and automatic governor • 3 piston rings |
|---|---|

Also Available! Same unit with 1 HP Electric Motor, 110-220 volts, 60 cy. \$129.00 f.o.b.

IMMEDIATE DELIVERY! SUPPLY LIMITED! ORDER FROM THIS AD

Send for CATALOG of Motors and Electrical equipment
ROBERTS ELECTRIC CO., Dept. 149, 849 W. Grand, Chicago 22, Ill.

AUTO RACING BOOKS AT NEW LOW PRICE

Automobile Racing — Fifth Edition by Ray F. Kuns.

This is a book for auto racing fans. It covers construction and specifications of racing cars and tells and shows how you can build your own. It also contains regulations for midget auto racing and describes roadster racing in California. A number of Indianapolis races are described and pictured.

Formerly \$1.00 per copy. Now just..... **50c**

Automobile Racing — Fourth Edition by Ray F. Kuns.

Includes eight working drawings and complete building instructions for standard midget racers as well as drawings for midget road cars. Miller Ford V8 front-drive racers are illustrated and described and other big-time data given. Large, clear pictures give inside information. Was \$1.00—Now only **50c**

POPULAR MECHANICS PRESS

200 E. Ontario St.
Chicago 11, Ill.

WISE-GRIPS "LOST" FOR 5 YEARS FOUND STILL CLAMPED UNDER TRAIN AFTER 300,000 MILES!



"In '48, after remodeling a railway car, I couldn't find my 2 Vise-Grips. In '53, when that same car came in for repairs, I removed a sill . . . found both tools still clamped to a bolt! After 300,000 miles of bumping and jerking — day after day for 5 years! I oiled them; they're good as new. What a tool!" — Mr. W. B.



WISE-GRIP WRENCH

DOES MORE JOBS EASIER
THAN ANY OTHER TOOL!

True stories like this show why Vise-Grip is the **HANDIEST** tool of all! A squeeze of the hand locks these powerful jaws onto work with *Ton-Grip*. Pulls, bends, turns, twists, ratchets, cuts — **WON'T SLIP**. A whole tool kit in one trim tool! At your dealer.

7W, 7" \$2.25
10W, 10" 2.40

Made only by PETERSEN MFG. CO., DEPT. M-3, DE WITT, NEBR.

ORDER FROM OLSON FOR GREATEST BUYS IN RADIO-TV SUPPLIES

**OLSON SAVES YOU \$55.00
ON WILCOX-GAY DUAL-SPEED
RECORDIO TAPE RECORDERS**



**REGULAR \$159.95
Stock No. AMP-10-M
RECORDS
AT 3 3/4" &
7 1/2" PER
SECOND**

\$104.95

Record your favorite Music, Radio-TV Programs, Family Highlights, Conferences, etc. Portable Recordio Features foot-press push-button keyboard, 2 speeds—records, plays back, crases. Handles up to 7" reels—records or plays back 2 full hours at 3 3/4" per second, 1 hour at 7 1/2" per second, on 7" reels. Frequency range 60-10,000 cps. Complete—ready to operate. Includes microphone, 7 ft. break-away AC cord, external speaker jack, 5"x7" elliptical speaker, tone control, Neon overtones indicator, 4 tubes, re-movable cover and full operating instructions. 110-120 Volt, 60 cycle, AC, U.L. Approved. Size 12"x14"x9". Shpg. wt. 25 lbs.

FINEST PLASTIC BASE



**RECORDING TAPE
1200 FT. REEL
STOCK NO. X-249-M
SINGLE, EA. \$2.19
LOTS OF 10.....**

**\$199
EA.**

Save up to 64% on strong, guaranteed, oxide coated Recording Tape. 1 1/2" wide. Freq. response 50 to 8,000 cycles. Plastic reel included. Reg. \$5.50. Shpg. wt. 1 reel—1 lb.

MINIATURE MOTOR



**Special — 3 for \$2.95
STOCK NO.
X-403-M, EA.**

\$119

Small size, hi-power, 1 1/2"x1 1/2"x3/8". Shaft dia. 3/32". Operates on 3 to 6 Volt DC. Five pole armature, bronze bearings, Alnico 6 magnet, beryllium brushes. Shpg. wt. 1 lb.

REAR DECK AUTO SPEAKER OUTFIT



**Enameled Aluminum Grille
Rugged 6" x 9" Speaker
3-way Switch. Hardware,
Wire and Instructions**

**STOCK NO. \$634
RA-139-M**

Complete matched extension set for rear deck installation in any car. Three-way control switch permits operation of front, rear or both speakers at once. Shpg. wt. 5 lbs.

**NEW NAVY TRAINING
ADJUSTABLE HEADPHONES**



**STOCK NO. X-356-M
3 PR. \$8.50. PAIR**

\$299

All bakelite cases. Adjustable headband slides. Complete with 4 1/2' cord. For all receivers and crystal sets. 2000 ohm impedance. Shpg. wt. 3 lbs.

3-TUBE AC-DC RADIO KIT



**2-Band Including Short-Wave
STOCK NO.
RA-121-M**

\$1176

Tunes 550-1700 KC on broad-cast band and 6-18 MC for short-wave. Operates on 115 Volts AC or DC. Complete with 4" PM Speaker, lens tubes. Uses one each, 35Z5, 50L6, 125T7 tubes. Shpg. wt. 7 lbs.

RCA Set of 3 Matched Tubes For Above. Shpg. wt. 1 lb.
STOCK NO. AS-115-M..... \$2.71

2-TUBE AC-DC RADIO KIT \$735

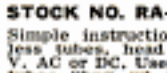

STOCK NO. RA-120-M. Only...

\$735

Simple instructions and diagrams. Complete lens tubes, head set, wire and solder. 115 V. AC or DC. Uses one each: 125T7 and 35Z5 tubes. Shpg. wt. 5 lbs.

RCA Set of 2 Matched Tubes For Above. Shpg. wt. 1 lb.
STOCK NO. AS-116-M..... \$1.73

**CRYSTAL SET KIT
STOCK NO.
RA-119-M**

\$329

Contains all parts for a fine Crystal Set. Includes headphone, crystal, chassis, tuning coil, hardware and all wire. Simple instructions. Shpg. wt. 2 lbs.



**V-M TRI-O-MATIC
Automatic 3-Speed
RECORD CHANGER**

**with Shure Turnover Cartridge
STOCK NO. RA-149-M
ONLY**

\$2795

Plays all records 100% automatically. Records are LOWERED, not dropped, on a cushion of air. Complete automatic operation on all 33 1/3, 45 and 78 RPM records, sizes 7", 10", and 12". Shuts off automatically after last record. Completely "jam" proof. Equipped with latest Shure "Turnover" Cartridge and 2 long life needles. Record Capacity: Twelve 10" or ten 12", 30 1/2 or 78 RPM; Twelve 7", 33 1/3 or 45 RPM. Another feature is 10" and 12" discs of the same speed may be inter-mixed. U.L. Approved. Size: 13-3/16" wide x 1 1/8" deep, overall height 7 1/4". Shpg. wt. 12 lbs.

Tri-O-matic Mounting Base—STOCK
NO. X-362-M. Shpg. wt. 4 lbs. EA. \$4.95



**Deluxe Kit of 10 Plastic
TRANSPARENT BOXES
Complete Set 10 Assorted Sizes.**

**STOCK NO.
AS-65-M**

**\$195
SET**

Hundreds of uses. Perfect for stamps, jewelry, nuts and screws. 10 sizes range from 4-compartment 8"x3 3/4"x1 1/2" to 1"x1"x1 1/2". All have hinged lids and snap-lock on front. Shpg. wt. 2 lbs.

**NEW "POWERFONE" TELEPHONE SET
WITH BUILT-IN SIGNAL BUZZERS
COMPLETE—2 HANDSETS,
2 BATTERIES, 50 FT. CABLE
AND 2 PHONE HANGERS**



**STOCK NO.
X-401-M**

\$595

Olson has sold thousands of these self-powered "Powerfones." The complete QUALITY Handphone and Intercom System. Gold-plated microphones diaphragm ensures perfect tonal quality up to one mile. "Powerfones" set connects in 2 seconds—simply insert batteries into the handles, connect the 2-conductor cable and it's ready to operate. Press one button and buzzer sounds on other phone and vice versa. Press other button and you can hear each other loud and clear.

Ideal system for TV Installer, Linesman, Repairman, Surveyor, Engineer, Dispatcher, invaluable to the Shop, Office, Garage, Store, Warehouse or in the field where quick, efficient inter-communication is needed. Order several sets for yourself and your friends, MONEY BACK GUARANTEE if not TWICE AS GOOD as you expected. Shpg. wt. 4 lbs.



**JUMBO HARDWARE KIT
IN POLYSTYRENE CASE
STOCK NO.
AS-109-M**

\$149

2 1/2 pounds of handy nuts, bolts, screws, washers, lock-washers, brackets, angles, rivets, gears, studs, all shapes and sizes. Transparent case with snap lock hinged lid. Shpg. wt. 3 lbs.

**STOPS "Solder-job" Holdups
WEN SOLDERING GUN**

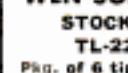

**STOCK NO
TL-22-M**

\$971

Pkg. of 6 tips for gun. Stock No. TL-23-M 80c heats almost instantly; economical trigger control saves on electric bills; built-in spotlight and "long reach" replaceable tip combine to make the tightest corner solder job easy. Sturdily constructed—heat and shock resistant, fully guaranteed. 250 Watts 120 V.—AC. Shpg. wt. 5 lbs.



**GENUINE RYTEL TV
PICTURE TUBE
REJUVENATOR**

**PRICE SLASHED 75%
STOCK NO.
T-113-M**

**ONLY \$795
EACH**

Give new life and brightness to low emission picture tubes by increasing cathode current. For use on any size picture tube. Easy to follow instructions included. Make big money rejuvenating picture tubes. Shpg. wt. 4 lbs.



**"Lucky 7" Hook-up Wire Kit
STOCK NO. AS-59-M**

**\$245
Kit of 7 Cells**

You get 7 coils of hook-up wire, different colors in rubber, braided and plastic insulation. Each coil 50 ft. Shpg. wt. 5 lbs.

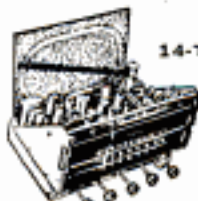

**BRAND NEW
14-TUBE HI-FIDELITY**

**ESPEY AM-FM
RADIO CHASSIS
PUSH-PULL—
13 WATTS OUTPUT
REGULAR \$160.00**

**STOCK NO. RA-150-M
YOUR COST ONLY.....**

\$6995

Olson offers you this famous radio chassis specially designed for Quality Custom Installations at a savings of over \$90.00. We made a cash deal and you get the benefit.

This is your chance to get superior performance, highest quality, finest AM-FM reception at an unbelievable bargain price.

Equipped with built-in Pre-Amplifier for GE or any low variable reluctance or standard crystal pick-up—ideal for phonograph hook-up. Full AM-FM Tuning Ranges, Frequency Range 30 to 15,000 cycles, Chassis Size 13 1/2" wide x 8 1/2" high x 10" deep. Escutcheon cut-out 4 1/4" x 7 1/2".

Packed in factory sealed carton. Complete—ready to operate—14 tubes (3 dual purpose—equivalent to 19 tubes), AM loop antenna, hardware, brackets, knobs, mounting template, and escutcheon. Shpg. wt. 18 lbs.



**NEW 1954 MODEL
12" CO-AXIAL SPEAKER**

**STOCK NO. \$1295
S-168-M**

Olson's most popular speaker because it's guaranteed to be equal to or better than any \$35.00 speaker, 12 watts output. Response 35 to 15,000 cps — 8 db, 8 ohm impedance. Crossover 2000 cps. 6.8 ohm. Alnico 5 Magnet in woofer. Specially designed cone in 5" built-in tweeter reproduces high notes with beautiful clarity. Aluminum voice coils. Matches perfectly with Espey Radio Chassis on this page. Replace those small distorted speakers in your radios, TV or custom installations. Only two wires to connect. Satisfaction guaranteed or your money back. Shpg. wt. 10 lbs.

QUALITY PM SPEAKERS

Permanent Alnico 5 Magnets



For use with all sets. Brand new Akrad Speakers in Factory Cartons. All have 3.2 ohm voice coils except 12" which is 6.8 ohm. Shpg. wt. 4" to 6", 3 lbs. 8" to 12", 5 lbs.

Stock No.	Size	Only	Stock No.	Size	Only
S-4-M	4"	\$1.69	S-86-M	8"	\$3.49
S-5-M	5"	1.79	S-97-M	10"	3.95
S-7-M	6"	2.29	S-111-M	12"	5.95



**DELUXE TUBE AND
TOOL CASE WITH
RYTEL GLO-AID FREE**

**STOCK NO. \$1095
X-348-M**

SAVE \$5.00
Ruggedly constructed, 13 separate compartments, one with internal door. Double folding top. Size: 16 1/2" L x 14" H x 8" W. Corners reinforced with nickel-plated protectors. FREE GLO-AID tests high voltage with built-in neon bulb. Solder-aid tool on other end makes solder jobs easy. Shpg. wt. 7 lbs.

AKRAD RADIO AND TV TUBES

100% Guaranteed • Save Up to 64%

Type	Reg.	Only	Type	Reg.	Only
02A	\$1.65	.69	6J6	\$2.50	.99
1B3GT	2.65	.99	6SN7GT	2.55	.79
1X2A	2.65	.99	12SA7	2.10	.79
5U4G	1.75	.69	12SK7	2.00	.69
5Y3GT	1.35	.49	12SQ7	1.75	.69
6AK5	4.35	1.39	35W4	1.35	.49
6AU6	1.85	.59	35Z5	1.40	.49
6BGGG	5.25	1.59	50L6	1.80	.69

Send for our complete Bargain List of Akrad Tubes. Also Genuine Factory Fresh General Electric Tubes in sealed cartons at 50% Discount from Regular Prices. Shpg. wt. per tube 8 oz.

FREE! Send for our GIANT WHOLESALE BARGAIN CATALOG of Radio and TV Parts and Accessories. Also if you live in or near Chicago, Illinois or Cleveland, Ohio visit our Bargain Stores. In Chicago—623 W. Randolph St. In Cleveland—2020 Euclid Ave.

ORDER FROM THIS AD. Send 25% deposit for COD orders or full remittance by Money Order or Check. Include enough for postage, we refund every cent not used, or have us ship by Railway Express. Every Item is 100% Guaranteed. PLS. MINIMUM ORDER \$3.00.

OLSON RADIO WAREHOUSE • 276 E. MARKET STREET • AKRON 8, OHIO

YOUR SMARTEST BUY!
Solid Birch & Maple
Captain's Chairs
READY-TO-PAINT

2 for \$14.95



FACTORY LOW PRICES SAVE YOU MONEY! You'll use them in every room — clean carved lines blend with all your furniture. Completely assembled, smoothly sanded — ready to paint, stain or lacquer. Solid birch or maple construction will last thru year after year of rugged use. Seat 17" x 16 1/2", overall ht. 28 1/2".

FREE! Handy folder "How to Finish Unpainted Furniture" shows you the fastest, easiest do-it-yourself method.

Also available: CHILDREN'S CAPTAIN'S CHAIRS—exactly like the grownup models! Seats are 12" x 14", seat ht. 12". Colonial or Modern. 2 for \$10.95.

Packed 2 of a kind to cartons—minimum order accepted. 2 chairs. Fast delivery—shipp. chgs. collect. Send Check or Money Order. Money-Back Guarantee. Sorry no C.O.D.'s.

MAKERS OF FINE CHAIRS SINCE 1857

MEADOWBROOK INDUSTRIES
 West Hempstead 24, N. Y.

NEW!

UTICA[®]
No. 92[™]
LOCKING
WRENCH



It's adjustable... it locks
 ... it clamps like a vise

this lever
 does it

The newest and handiest thing in wrenches! Just what you've always wanted for the toughest of jobs. Replaces complete set of open end wrenches. The lever works like a charm to lock jaws in position or to clamp jaws like a vise.

Your dealer has the new No. 92[™] Locking Wrench or can get it for you. Or write us. Sizes 8", 10", 12". Popular 10" size, \$3.85.

U T I C A
No. 92[™]

UTICA DROP FORGE & TOOL CORPORATION
 Utica 4, New York

Remember the name

COMPLETE Metal WORKSHOP

FOR HOME
 AND PLANT

NOW Only
\$6.95 POST-PAID

A Bench Tool that
FORMS
SHEARS
PUNCHES
& RIVETS



4-Tools-in-1

One small compact machine gives you a complete metal workshop: Bending and forming dies make smooth, sharp bends in either bar or rod stock. Hardened steel shearing jaws shear metals cleanly up to 1/4" thickness. An efficient punch press, complete with 3/8", 3/16" and 1/4" punches. Rivets quickly and easily with punch press and rivet dies. Complete with 3 different size punches and die plate, NOW Only \$6.95 delivered. We pay postage.

Satisfaction Guaranteed or Money Back
 Simple, sturdy, easy to operate. Mounts easily on any work bench. Ideal for any repair shop, tinkerer, do-it-yourself hobbyist. Send cash, check or money order. No C.O.D.'s.

Bancroft's

1112 So. Wabash Ave. Dept. PM-1 Chicago 5, Ill.

WAR SURPLUS CIGANTIC **SAVE UP TO 85%**
 SALE

<p>NEW HI-SPEED DRILLS 30 ea. 1/60-1/4 for \$3.25 10 ea. 1/4-1/2 for \$3.50</p> <p>Imported Precision Squares Accuracy Guaranteed Hardened Blades Precision Ground</p> <table border="0"> <tr> <td>2" 1.30</td> <td>5" 2.00</td> <td>10" 5.00</td> </tr> <tr> <td>3" 1.50</td> <td>6" 2.25</td> <td>12" 6.00</td> </tr> <tr> <td>4" 1.67</td> <td>8" 3.30</td> <td></td> </tr> </table> <p>8 pt. Comb. Set 2" to 12" 19.95</p>	2" 1.30	5" 2.00	10" 5.00	3" 1.50	6" 2.25	12" 6.00	4" 1.67	8" 3.30		<p>"HELEX" CALIPERS \$5.95—Case \$1.00</p> <p>Import. Stain. Steel Caliper w/case 9.95 Accuracy Guar.</p> <p>Build Your Own ARC WELDER D.C. Gen. P.I. 24V. 200 Amp. including Diagram \$12.95 D.C. Gen. R.I. 30V. 300 Amp. including ing Diagram \$21.50 Condition</p> <p>Sensitive Altimeter (Pioneer) AN-5761-1 0-35,000 Condition Perfect. \$10.95 Brand New Altimeter 0- 10,000 \$6.50 (Send for Cat.) 1507 S. La Cienega Los Angeles 35, Cal., Dept. M3</p>
2" 1.30	5" 2.00	10" 5.00								
3" 1.50	6" 2.25	12" 6.00								
4" 1.67	8" 3.30									

Check or M.O. 25% Dep. on C.O.D. — F.O.B. L.A.

METRO PRECISION TOOL CO.

Do a Real Professional-Like Job
 Yourself and SAVE

HOW to PAINT
 With Brush and Spray

Covers All Painting Methods and Materials

You can do professional-like painting and finishing jobs yourself and save about two-thirds of the cost. Sam Brown, noted craft authority, makes it so easy for you in his book, **HOW TO PAINT WITH BRUSH AND SPRAY**. Order your copy now and enjoy this tremendous saving. It covers exterior painting, wall and interior decorating, furniture finishing, concrete painting — every type of painting with brush, spray gun, roller and other methods. Tells what finish is best; what materials to use, etc. No previous experience needed. Fully illustrated. Order by mail. Only \$2.50. Money back if not pleased.

POPULAR MECHANICS PRESS, Dept. PM18
 200 E. ONTARIO ST., CHICAGO 11, ILL.



KOREA
Favorite Knife

\$3.95
 each
 postpaid

This is the original **BRITISH COMMANDO KNIFE** of finest Sheffield steel which became the favorite of troops in Korea. A priceless collector's item, a fine hunting knife. Shipped in original British ordnance metal tipped leather sheath. Send check, cash or m.o. Sorry, no COD's. For U.S., APO or FPO air mail, add 80¢ per knife. Dealers inquire. Calif. resid. add 3% state tax. In Canada: order from United Surplus Sales, 471 Portage St., Winnipeg, Manitoba.

PASADENA FIREARMS CO.
 63 Sports Bldg., 973 E. Colorado St.
 Pasadena 1, Calif.



Fix electrical equipment like a "pro"

WITH THE AMPROBE Jr. VOLT-AMP POCKET TESTER



Now for the first time readers of this magazine can order, direct by mail, the famous troubleshooting tool used by the top electricians and service men. Amprobe Jr. makes it much easier to diagnose what's wrong with house circuits, shop motors, washing machines and driers, air conditioners, pumps, etc. (You will often be able to trace the source of trouble without even having to look inside the equipment.) Pays for itself over and over. To measure current instantly without connections or wire splicing, just snap the Amprobe around one conductor, insulated or uninsulated. To measure voltage, plug in the test leads. Order your Amprobe Jr. from one of America's leading electrical parts wholesalers, at the low "net" price of \$19.85, including voltage test leads. Model 500 has a range of 0-100 amp A-C, 0-150/600 volts A-C. Other ranges also available. Send check or money order today. We pay postage. Money back immediately if not completely satisfied. Or write for free literature. BROWNELL DISTRIBUTORS, INC., Dept. 31-PM, 55 Lispenard Street, New York, 690 Murphy Street, Atlanta, Georgia.



SAVE ON THESE BARGAINS TODAY

FLOCK GUN & DUST SPRAYER
For dusting plants, etc. Easy to use, works off compressor, 14" in length. Sprays insecticides, powders. Also use for lub. gun. 3 lbs. **\$2.95**

V BELT CLUTCH
Takes starting load off engine or motor. "A" belt, 2.35 pitch diameter. 3/4" bore, ball bear. Price **\$7.50**
3/4" bore. **\$8.50** Flushing for 1/2" shaft **15c**

WELLWORTH BLOWER BARGAIN
Operates softly. Dbl. wheel inlet, dbl. width blower. For heating, ventilating, cooling, etc. Wheel 10", Outlet 13 1/2" by 11 1/2", inlet 8 1/2" by 10" high, 18" wide, 16 1/2" deep. CFM 1 1/2, S.P. 1600, outlet vel. 1575. Weighs 45 lbs.
Blower with drive, less motor **\$29.95**
Outfit with 1/4 h.p. motor **\$45.00**

COMPRESSOR OUTFIT FOR SHOP AND FARM
Compressor, pressure tank, air gauge, check, 20 ft. hose, safety valve, copper tubing with 4 flared fittings to connect compressor to tank, 4 way cross and 3 nipples. Compressor cast iron flywheel, both valves in head, bronze bear., splash lub., V belt drive, intake muffler, 2" bore, 1 3/4" stroke, 2.8 cfm to 150 lbs. pres. As above, weight 30 lbs. **\$32.45**
Compressor only **\$20.50**
Outfit less compressor, 14 lbs. **\$12.45**

WELLWORTH COMPRESSOR SPECIALS

Model 800 As in above unit 2" bore, 1 3/4" stroke, 2.8 cfm up to 150 lbs. Use with 1/4 h.p. motor. \$20.50 Ship. wt. 16 lbs.	ALL PRICES F.O.B. Chicago Send for FREE Catalog Dept. D3	Model W7 2 cylinder 2 1/2" x 2" 5.10 up to 8.50 cfm up to 150 lbs. Use with 1/2-3/4-1-1 1/2 h.p. motor. Heavy duty compressor. \$59.95 Ship. wt. 45 lbs.
--	---	--

WELLWORTH TRADING COMPANY
1832 S. WABASH AVE. CHICAGO 16, ILL.

DR. GRABOW PIPES



BECAUSE THEY'RE PRE-SMOKED

AUTO DEALERS
TOY STORES
WRITE US
FOR DEALER
PRICES
ON YOUR
LETTER-
HEAD

ESHELMAN 70 MILES PER GAL. GAS CHILD'S AUTO WITH MOTOR

Sturdy, Safe for kids 5 to 15 years. Also pulls Mowers, Carts and Power Takeoff drives Pumps, Saws, etc. Write for literature. **2 H.P.**
Esheleman, Dept. CM-43
119 Light St.,
Balto., Md.
333 N. Michigan Ave.,
Chicago-1, Ill.
7070 N. Wood Blvd.,
Los Angeles 28, Cal.



BARRON Drill Press TOOLS



ROTARY PLANER
Planes • Rabbits
Tenons • Panels
Routs • Bevels
Only **\$8.50**
COMPLETE

FOR WORKSHOP AND INDUSTRIAL USES...

Over 40 precision built woodworking tools and accessories... Hi-Speed Router Bits—Rotary Surface Sanders & Drum Sanders—Safety Shaper Cutters—Dovetail Cutters—Large Auxiliary Metal Tables—All Metal Shaper Fences—Spindle Adapters—Handy Bench Vises. Many other items indispensable for accurate, useful, versatile workshop use. Every tool sold on complete satisfaction or your money back. See your Barron Dealer. Ask for special folder—"24 Extra Uses for Your Drill Press."

FREE
Workshop
Guide &
Catalog

BARRON TOOL CO. INC.
364 Architects Bldg., Detroit 1, Mich.

Do It Yourself! SAVE \$30



ALL-ALUMINUM STORM-SCREEN DOOR
\$69.95 Value **\$39.95***
ANY STANDARD SIZE
Push Grille Extra



Guaranteed by Good Housekeeping
*NOT ALL ADVERTISED DEALERS

Comes complete with Pneumatic Door Check, 3 Stainless Steel Hinges, Outside Aluminum Door Jamb, Latch Set and Wind Limit Chain
Over 1" Thick • Rugged All-Aluminum Construction • Adjustable for Perfect Fit • Aluminum Door Jamb • Heavy Aluminum Kick-Plate • Glass & Screen Inserts Interchanged Easily!

DELIVERED COMPLETELY ASSEMBLED! EASILY INSTALLED BY ANYONE!

*Slightly higher in some Areas.

Available at leading lumber or hardware dealers everywhere, or write:
the weather-proof co. Dept. PM
1407 E. 40th St., • Cleveland 3, Ohio

112 PIECE ASSORTMENT \$3.95
FOR ELECTRIC GRINDER
\$10.00 VALUE - ONLY
Post-paid

Here's what you get! Mounted Stones on 1/4" mandrel, Drum Sander, Rotary Cutters, Wire Scratch Brush, Bristle Brushes, Circular Saw, Grinding Wheel, Grinding Wheel, Rubber Polishing Wheel, Cut-off Wheel, Rubber Cylinder, Mandrels to fit above tool, 250's Sanding Discs, Sharpening Stone, etc.

18 ROTARY CUTTERS \$5.85
\$13.50 Value
Illustrated 1/2 actual size
Post-paid

Assorted sizes cutter on 1/4" or 3/32" shank. Will fit all hand grinders. Ideal for cutting wood, metal, or plastic. Brand new.

12 MINIATURE CUTTERS \$1.00
FOR CUTTING WOOD, PLASTIC, or METAL
Actual size. Assorted shapes on 3/32" shank. For die makers, home workshop, etc.
36 SHORT SHANK MINIATURE CUTTERS \$1.00
Post-paid

12 MOUNTED WHEELS and points on 1/4" Shank \$2.95
Post-paid

For grinding on plastic, wood, soft and hard metals. Regular List Value \$8.40.

12 MTD. WHEELS ON 1/4" SHANK \$3.60
Post-paid

18 MOUNTED POINTS ON 3/32" SHANK \$2.50
Post-paid

SCHUPACK'S AMAZING TOOL BARGAINS!
Save Up to 100%!

Woodworkers' Drills \$2.00 P.P.
4 drills, from 5/16" to 1/2" with 1/4" shanks. Brand new, popular sizes. Set #14.

5 Woodworkers' Drills From 1/4" to 3/4" Set #15 Post \$2.95

HIGH SPEED DRILLS

7 High Speed Drills \$1.00 P.P.
15 DRILLS \$2.00! Popular sizes—up to 1/4". Brand new, Set #16.

75 MOUNTED WHEELS & MINIATURE CUTTERS \$4.50
Post-Paid

Regular \$11.00 value. For cutting and grinding on wood, metal or plastic. Includes 26 mtd. wheels and points on 3/32" shank; 24 miniature cutters on 3/32" shank; 25 short shank min. cutters. Will fit all electric drills and hand grinders.

FLEXIBLE SHAFT - ONLY \$4.95
Post-Paid

Fits all electric drills & hand power tools. 35 1/2" long. Oilite bearings. Core of specially wound, high carbon steel wire in flexible steel casing. Will accommodate tool shafts up to 1/4" dia. For light electric drilling, etc.

2 CIRCULAR SAWS \$1.50
ON 2 MANDRELS - ALL AT ONE LOW PRICE
Post-Paid

1" diameter saws on 1/4" Mandrels. For cutting wood, plastic, or soft metals. Order at once! Send Check or Money Order.

ADAPTER CHUCK \$1.50
Post-Paid

With 2 interchangeable collets, opening from 3/32" to 0, on 1/4" mandrel. Price each only.

2 DRUM SANDERS \$1.50
Post-Paid

With 12 Bands in Assorted Grits. 1/4" dia. x 1" long on 1/4" arbor with 12 bands

ONE DRUM, 1" DIA. x 1" LONG ON 1/4" ARBOR WITH 8 EXTRA SLEEVES \$1.00
Post-Paid

SCHUPACK SUPPLY CO., 7331 COTTAGE GROVE AVE., DEPT. M-52 CHICAGO 19, ILL. SEND CHECKS OR M. O. NO COD'S PLEASE

ESHELMAN FOR Better LAWNS And GARDENS

Women Can Operate It. Free Catalog. Write **ESHELMAN Dept. R-53** 119 Light St., Malto, 2, Mo. 333 N. Michigan Ave., Chicago - 1, Ill. 7070 Hollywood Blvd., Los Angeles 28, Cal.

MAKES FLOWS CULTIVATES HARROWS HAULS SPRAYS SAWS DOZER MOWS CUTS ROLLS TRACTORS TILLS SNOW PLOW

1 to 8 H.P. Also WALKING \$69

Guide to HOME REPAIRS

Pays for Itself 100 Times Over

Beat the high cost of home upkeep. Save hundreds of dollars every year on carpentry, electrical, painting, plumbing and other jobs around the house with **POPULAR MECHANICS GUIDE TO HOME REPAIRS**. Simplified how-to-do-it instruction and 646 pictures make all jobs, inside and out, easy. Covers construction, remodeling, modernizing, repairing that you can do yourself at small cost. 112 page cloth bound book only \$2.50 postpaid. Order today under our money back guarantee.

POPULAR MECHANICS PRESS, Dept. PM16 200 EAST ONTARIO STREET CHICAGO 11, ILLINOIS

20 "SEE THRU" DRAWERS!
LOWEST COST — HANDIEST STORAGE

MODEL J-20 \$7.95

Useful in every shop, lab., home, office, etc. For Radio, T.V. or ignition work. **KEEPS SMALL VICTS HANDY**. No other cabinet can compare in price, construction strength. "SEE-THRU" durable plastic drawers can't spill accidentally. Strong welded steel cabinet. Drawers 3 1/2" L x 2 3/4" W x 1-7/16" D divide into 2 or 3 LENGTHWISE or CROSSWISE compartments. Sent complete, postpaid. Money back if not satisfied within 10 days. Free catalog on other sizes.

J-24, 24 drawers \$ 9.95
J-32, 32 drawers 12.95
J-64, 64 drawers 24.95

Contents always fully visible, clean, dustproof, organized and orderly indexed.

MFG. BY AKRO-MILS, INC., 818 E. MARKET, AKRON 5, O.

DRIVE 500,000 MILES
Without Need of A Major Overhaul

ENGINEERS HAVE PROVEN THIS POSSIBLE. They have shown that the combustion process produces more than a gallon of water in vapor or steam for every gallon of fuel burned. (Ever notice the water that drips from your exhaust pipe?) Some of these vapors enter the crank case where they cause rust, varnish, and other serious damage.

INSTALL POWER VENTILATION ON YOUR CAR. Now you can increase the overall operating efficiency of your car with amazing, newly developed Moto-Vent which gives you Positive Power Ventilation and removes the water vapors, sulphur and other highly corrosive materials that enter crank case. Moto-Vent is not a "gimmick" or "gadget" but a precision engineered instrument designed to give better engine performance, more power, better fuel mileage, add life to your car and save you money. Oil and water vapors are fed back into the combustion chambers where they give you water injection and overhead lubrication, preventing back pressure, overheating, sticky valves and rings, sludge and carbon formation.

EASY TO INSTALL—DO IT YOURSELF. Fits all cars, trucks, tractors, old or new. Moto-Vent is installed between oil breather and intake manifold in less than half hour. Will pay for itself many times each year.

FREE 30 DAY TRIAL OFFER. Moto-Vent complete with all fittings and easy to follow installation chart only \$4.95 postpaid, or, C.O.D. plus charges. Try for 30 days. If you are not completely satisfied, return for full refund. Send order or write for further FREE particulars, today!

PRECISION PRODUCTS CO. Dept. 11 Harvard, Ill.

AUTOMATIC AIR COMPRESSOR

1/2 H.P. \$79.00
FREE \$12.00 QUART GUN

Moisture filter \$3.25 V-belt drive \$2.75
Hose and tire chuck \$2.50 Safety valve \$1.50
Check valve & copper tubing \$3.75
Small parts shipped parcel post prepaid at above prices.

Complete 1/2 HP unit assembled, ready to use—Plus Special FREE \$12.00 value Quart External Atomizing Spray Gun with every unit \$5.33... \$79.00 FOB Chicago

Save \$10.00 — 1/2 HP outfit knocked down, you assemble, free spray gun, \$12.00 value, \$K5 33... \$69.00 FOB Chicago

Same as above with larger 1/2 HP motor—free spray gun, knocked down unit \$K 55... \$79.00

1 1/2 H.P. \$69.00
FREE \$12.00 QUART GUN

1 1/2 H.P. Motor 12x24 Stainless Steel Tank, wheels, all accessories, large 4 CFM compressor, free gun... \$123.50 FOB

1 HP Motor 15x30 Tank Twin Cylinder 9 CFM Compressor, All Access. You assemble. Free Gun... \$169.50 FOB

C. MARSHALL SALES
Dept. P-3 Chicago 47

VOLUME BLOWERS FOR HEATING, VENTILATING, EXHAUSTING

Blowers for forced drafts, heating boosters, exhausters, coolers, dryers and dust collectors, 110 volt A.C., 50/60 cycle motors.

*75 CFM Blower, 3 inch wheel... \$10.75
*125 CFM Blower, 4 inch wheel... \$14.75
*200 CFM Blower, 4 1/2 inch wheel... \$19.50
*400 CFM Blower, 5 inch wheel... \$32.50
*600 CFM Blower, 6 inch wheel... \$38.50
*1000 CFM Blower, 8 inch wheel... \$52.00
*1500 CFM Blower, 9 inch wheel... \$72.00

*These blowers with motors shipped Post Paid. Larger sizes are FOB.

Write for CIRCULAR: Listing Motors; ALL SIZES; Fans and Air Compressors — ALL SIZES.

16 TO 1 SPEED REDUCERS
For Display Table — Barbecue Spits — Toy Auto Gear Box — Experimental Uses, Etc. Gears Enclosed in Aluminum Housing, Bronze Gear, Hardened Worm, Input Shaft 1/2 in. Output Shaft 3/8 in. Speed Reducer \$5.95 Post Paid
#R 161

NEW 100-200-300 POWER 'HYPOWER' MICROSCOPE

Here's a VALUE UNSURPASSED ANYWHERE! Has a triple objective revolving turret with 3 lenses that will allow 100, 200 or 300 power magnification. All-metal body built to incline through 90°. Built-in micro adjustment. Adjustable sub-stage mirror. Complete in handsome dovetailed hardwood case. Ideal for Lab, student, study of insects, etc.

SPECIAL 9.99

BARGAIN HOBBY MOTOR

Here's a real value for the hobbyist or home mechanic. This powerful little motor turns 2500 to 3600 RPM!

Has a double-end shaft fitted with an arbor for mounting small stones, wheels, buffers, etc. and a hand chuck for 3/32" and 1/8" shanks. MOTOR complete with arbor & chuck — **3.99**

FLEXIBLE DRIVE-SHAFT for HOBBY MOTOR
36 inches long and complete with necessary adapters to take grinding, buffing, polishing, wheel, etc. Shaft is 7/32" dia. Makes this motor a very versatile bench tool. **2.99**

30 PIECE DRILL KIT

Hi-Speed-Hi-Tens Chrome Steel Drills at LESS THAN WHOLESALE PRICES! Sizes from 1/16" to 1/2" in 6ths. This set of TOP QUALITY Twist Drills has been advertised elsewhere for \$34.95. We offer them in machine or jobbers lengths. **9.95**

FAMOUS SURPLUS MIXES

PALLEY HOSE CLAMP MIX — 24 Assorted size clamps — all of the finest aircraft quality. Ideal for use on auto, truck, tractor, boats, planes, etc. Don't be without this essential. **2.89**

GADGET MIX — Another SURPLUS BARGAIN! This amazing mix includes a 'TREASURE' of small parts such as: Cogs, Worm Gears, Wheel Bearings, Rivets, Spacers, Bolts, Screws, Springs and Clamps. \$ pounds for ONLY **1.19**

MARCHING COMPASS

Levantic type. An all-purpose precision instrument for surveyors, hunters, sportsmen, boy scouts, hikers, etc. Can be used for map orientation, taking azimuth reading or as a guide in unfamiliar terrain.

The bezel ring is marked in 3° notches for computation and rotates through 360 degrees. Has a special "peep" sight and hair-line guide in lid for taking a bearing on a distant landmark or object. **3.95**

NAVIGATORS MAGNETIC COMPASS

British Navy Type P-11. Like New. Has a rotating verge ring, calibrated in 1 degree increments from 0 to 360°. Two parallel grid wires for N-S and E-W line alignment. Ideal for small boats. **9.95**

NAVY OCTANT

Made for the U.S. Navy by the Pioneer Instrument Co. Type Mark 4. Designed for use in aerial navigation. May also be used on land or ocean. Has artificial horizon, dual prism, 4 filters, astigmatizer lens and many other valuable parts. The parts alone are worth many times the price.

Will give accurate calculations in sighting Sun, Moon and Stars. In original hardwood case **37.50**

PALLEY SURPLUS & NEW MERCHANDISE - SAVE!

NEW 200 PIECE POWER TOOL KIT

The Greatest Power Tool Combination Offered Anywhere At This LOW PRICE! Drills, Grinds, Polishers, Engravers, Curves and many other uses. Ideal for Wood, Metal, Plastic, Leather, etc. Powered by a "Duro", universal motor, streamlined to fit the hand, motor turns 28,000 RPM on 110 volt AC or DC current. Has sealed ball bearings, a 3/32" and 1/8" collar & button operated check lock. Combination includes 5 COMPLETE SETS containing Metal burrs, mounted stones, polishing brushes, felt wheels, discs, drills, blades in newly every conceivable shape. 200 PIECES — **19.98**

BAKERS DOZEN HOBBY & LAB KIT

Every Hobbyist, Model Maker, Lab Worker, etc. will wear this. Kit contains 1 Hobby Hammer with brass head, 2 inspection mirrors with detachable handle, 2 surgical hemostat clamps, 2 scalpels in case, 2 tweezers, 2 shaping tools & a Palley MYSTERY Special Item. **ONLY 5.99**

12 PIECE MOUNTED STONE SET

A Palley Bargain worth \$8.00. Has 12 mounted wheels and points on 1/8" shanks. Ideal for the hobbyist, home mechanic, etc. For grinding on plastic, wood, soft and hard metal. Don't miss this unusual value at only . . . **ONLY 2.29**

24 PC. STEEL CUTTER SET

For hobbyist, die maker, home workshop, etc. Assorted sizes cutters on 3/32" long shank. Designed to fit all hand grinders. Ideal for cutting plastic, metal or wood. All new. This **5.95** \$20.00 Value complete in handy plastic case.

9 PC. DRAWING KIT

Suitable for architect, draftsman, artist, student, etc. Has 9 separate pieces — one 5 1/2" divider; one each — 3 1/2" bow divider, bow pencil and a bow pen with wheel adjustment and reversible needle point; one 4 1/2" ruling pen with extra handle; one capsule of extra lead. All in a two flap velvet lined, pocket book carrying case. A Palley Special **5.89**

DIVING EQUIPMENT

NEW CO2 NEPTUNE HARPOON GUN 29.95 VALUE **13.95**

Has JET POWER — Simplest, most effective underwater gun. Made for one use. Weighs only 27 ozs. Has 150 lb. nylon line on snap-on reel. Positive safety catch. Rust resistant finish on all metal body.

CO2 CHARGES — Box of 10 charges for above gun. **ONLY 98¢**

OXYGEN TANK SPECIAL — Gives up to 1 hour underwater. at average depth. Has 15 lb. capacity — 48 cu. ft. Size: 6 1/2" diam. x 23 1/2". **17.95**

BUILD YOUR DIVING LUNG! Palley's carries all parts and equipment for skin diving. Write TODAY for info on our build-yourself lung for \$42.95. **Only 50¢** We'll refund your money on your first order for \$1 or more.

ARMY SURPLUS 1-BURNER STOVE
A genuine G.I. one burner stove. Fitted in its own carrying case. Has three fold-up legs and a built-in grill on top to hold pans. Burns reg. gas. A \$12.00 VALUE for ONLY **6.95**

NAVY WEASA FLEECE LINED ARCTIC JACKET
An extra heavy winter jacket. Fully lined with a thick sheepskin collar. Two large patch pockets. Full zipper. Adjustable waist snap. Knit inside storm cuffs. Outside is top quality, brown horsehide. Size: 36 and 48. **ONLY 24.95**

Air Corps Type LEATHER CAP — Has suede lining & fleece lined ear flaps. Small, Med., Lg. . . . \$2.59

LEATHER MITTENS — Fleece lined. Sizes: Small, Medium, Large. . . . per pair **Only \$2.69**

LEATHER PANTS — Full fleece lined, 3/4 length zipper on each leg, 2 knee pockets. . . . \$8.95

AVIATORS (AA-6310) WINDPROOF GOGGLES

Genuine Army type. Have interchangeable, precision ground lenses. Your choice of 3 lens colors — Clear, Amber or Green. Metal frames are rubber covered with soft, chamomile lining and have built-in, non-fogging breathers. **2.79**

EXTRA LENSES — Choice of colors above. Price per pair . . . **1.39**

GENUINE U.S. NAVY SHEEPLINED FLIGHT BOOTS

Wear with or without shoes. Have genuine leather uppers and rubber soles. Laces up the back for snug fit. Has two zippers front closure for easy off and on. Designed to protect from cold and weather. Soles have heavy NON-SKID tread. An ideal rough weather boot. Small, Med., Lg. Value \$22.00 **10.88**

ARMY RIFLESCOPE 9.95

Built to rigid Gov't specifications. Contains the finest precision, Achromatic optics. Has five double-element lenses, fully corrected for color and spherical aberration. 3 power magnification. Det reticle. Length 9".

7 TO 1 HANDY HOIST

Strongest hoist for its weight on the market. Will LIFT 1000 lbs. but weighs only 1 lb. Handy at home, on farm, in shop, etc. Consists of 2 pulley blocks, 100 feet of Nylon Cord, 2 Nylon slings and canvas bag. Easy to pack and carry. Ideal for hunters game hoist. **Only 12.50**

WORLD'S MOST AMAZING BARGAIN CATALOG

1954 EDITION 320 PAGES

Packed with SENSATIONAL VALUES in WAR SURPLUS, FACTORY CLOSE-OUTS and GENERAL MERCHANDISE! Fully illustrated. Thousands of items in Hand & Power Tools, Outdoor & Sporting Equipment, Hardware, Photo Supplies, Foam Rubber, Industrial Tools, Aircraft Parts, Metals, Plastics, Gadgets, Hydraulic Supplies & many, many more. **Only 50¢**



Order From This Ad. Pay by M.O. or check. P.O.'s accepted from D&S firms. 1/3 deposit with C.O.D.'s. All Prices FOB Los Angeles.

PALLEY SUPPLY CO 2363 E. VERNON AVE. DEPT. PM3 LOS ANGELES 39, CALIF



**Hoot
Mon!**

HERE IS **A REAL SHOP VALUE**

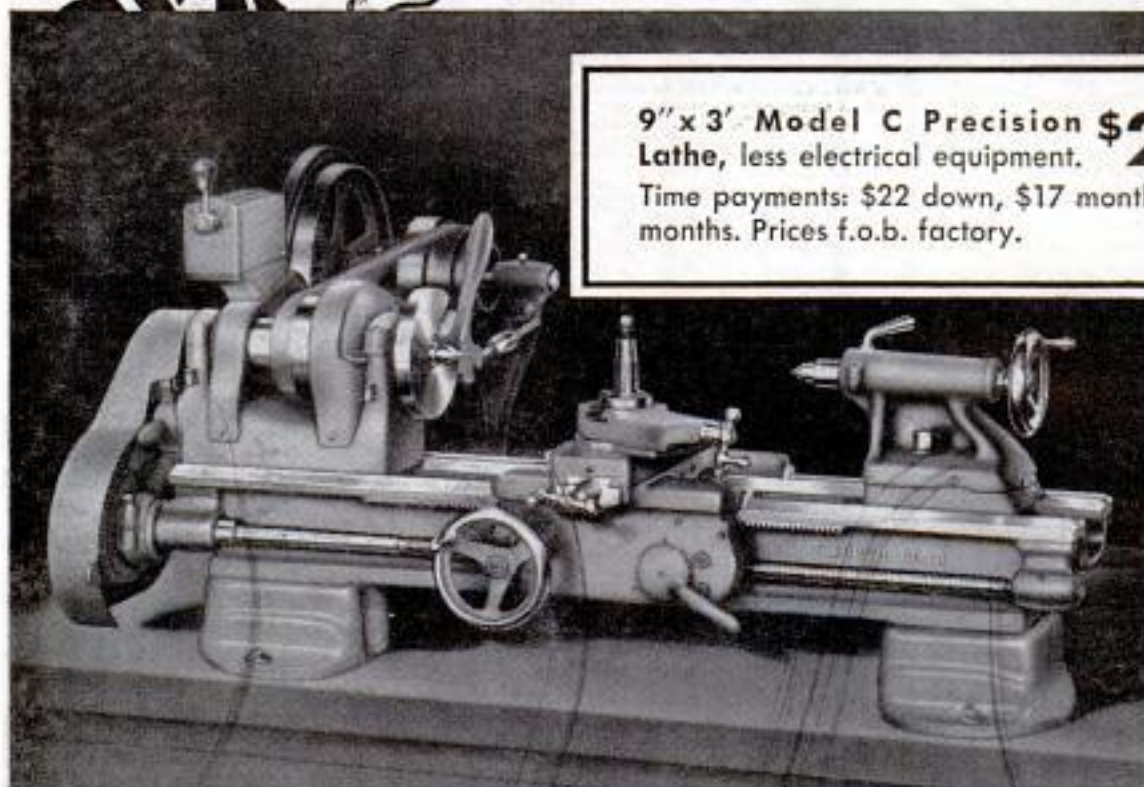

9' x 3' Model C Precision **\$211⁰⁰**
Lathe, less electrical equipment.

Time payments: \$22 down, \$17 monthly, for 12 months. Prices f.o.b. factory.



Lathe values aren't measured in dollars. They are gauged by accuracy, versatility and dependable service. That's what makes South Bend 9' Lathes such remarkable values — they give you more of what you actually need.

They are built to the same high standards and with the same skilled workmanship as larger South Bend Lathes. This makes them capable of precision work of all kinds in the small shop or close-tolerance production of small parts in the large manufacturing plant. Their versatility covers the entire range of lathe operations and is supplemented by numerous attachments available for special classes of work.

Compare these lathes with all others, regardless of price, and you'll see why you get more for your money in a South Bend.

HOW TO RUN A LATHE

Every lathe operator needs this popular reference handbook on lathe operation and care. 128 pages of helpful information. 365 illustrations. Send 50¢ for your copy.

**Can I get it?
When? How?**

Yes—you can get just any South Bend product immediately from our distributor's stocks in principal cities. Items not stocked, shipped promptly from factory.

Three ways to order:

1. See or telephone nearest distributor.
2. Order by mail from your distributor.
3. If no distributor is nearby, order direct from factory.

South Bend machine tools with accessories may be purchased on convenient terms up to 18 months.

**SEND INFORMATION
CHECKED:**



9" and 10"
BENCH LATHES



10" to 14-24"
FLOOR LATHES



DRILL
PRESSES



TOOL
GRINDERS



1/2" & 1" Collar
TURRET LATHES



7"
BENCH SHAPERS

Name _____ Company _____

Street _____ City & State _____

Building Better Tools Since 1906 • **SOUTH BEND LATHE** • South Bend 22, Indiana



Dreamship on a budget

...million-dollar fun!

You've dreamed of the day! And now it's here... the wonderful day when you can skipper your own eat-aboard, sleep-aboard *live-aboard* cruiser... swift, able, comfortable! Your cruising range is America-wide. Roam the waters close to home, or trailer your craft to far-away shores. Cost-wise the news couldn't be better! From inexpensive kit boat to ready-to-go cruiser you can buy in various stages of construction to suit any budget.

For power, one choice—it's BIG TWIN, the motor that made outboard cruising not only practical, but tops in cruising fun! 25 eager horsepower for speeds to 20 miles on light cruisers—up to 30 miles with twin motors. And now with finger touch *electric starting* if you wish, with complete remote control at steering position for'd—starter, choke, throttle, gearshift—finger tip handling ease!

SEE YOUR EVINRUDE DEALER—look for his name under "Outboard Motors" in the yellow pages of your phone book. For complete catalog and Evinrude "How-to" Book of Outboard Cruising, write EVINRUDE MOTORS, 4300 N. 27th Street, Milwaukee 16, Wis.

IN CANADA: Manufactured by Evinrude Motors, Peterborough.



BIG TWIN
25 O.B.C.
Certified
25 H.P. at
3000 R.P.M.

Evinrude

quiet

OUTBOARD MOTORS



...free

Write for full-color catalog of the complete Evinrude line, and copy of new "How to" Book of Outboard Cruising, both free!

Copyrighted material

Donna Atwood

AMERICA'S NO. 1 "QUEEN OF THE ICE"

Dazzling star of the Ice Capades of '54, "Greatest Show On Ice", says:

"I LIKE
CAMELS—
YOU WILL, TOO!"



SHE LEAPS...



SHE GLIDES...



SHE DANCES...



SHE SPINS...



SHE SMOKES CAMELS!

I STARTED
SMOKING CAMELS
NINE YEARS AGO.
I FIND CAMELS'
DELIGHTFUL MILDNESS
AND FLAVOR SUIT ME
JUST RIGHT, YEAR
AFTER YEAR!

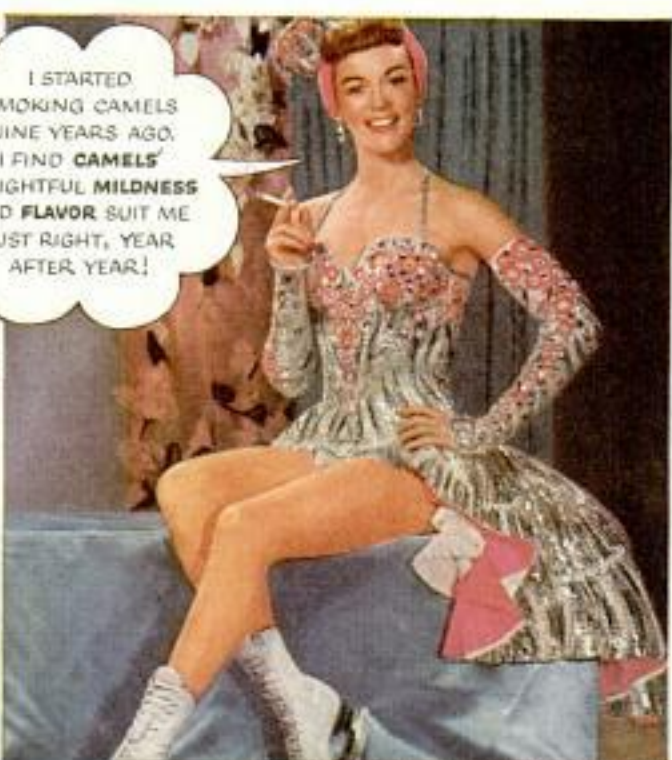

H. J. Reynolds Tobacco Co., Winston-Salem, N. C.

AMERICA'S NO. 1 CIGARETTE...

*for Mildness,
for Flavor...*



Camels agree with more people than any other cigarette!

LIKE Donna Atwood — like men and women smokers everywhere — you rate the cigarette that rates tops in America for mildness and flavor . . . Camels! Yes, Camels lead all other brands in popularity — by billions. You owe it to yourself to try Camels for 30 days . . . see how much pure pleasure you've been missing!



**MAKE THE
30-DAY CAMEL
MILDNESS TEST**

Only your own 30-day test can tell you best which cigarette is best for you!